

STARPOWER

SEMICONDUCTOR

IGBT

GD1200HFY120C3S

1200V/1200A 2 in one-package

General Description

STARPOWER IGBT Power Module provides ultra low conduction loss as well as short circuit ruggedness. They are designed for the applications such as high power converters.

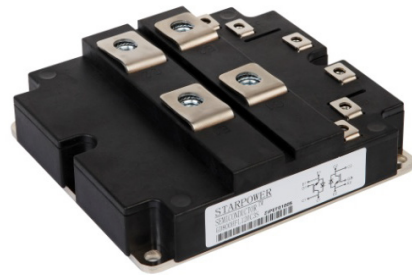

Features

- Low $V_{CE(sat)}$ Trench IGBT technology
- 10 μ s short circuit capability
- $V_{CE(sat)}$ with positive temperature coefficient
- Maximum junction temperature 175°C
- Low inductance case
- Fast & soft reverse recovery anti-parallel FWD
- Isolated copper baseplate using DBC technology

Typical Applications

- High Power Converters
- Motor Drivers
- AC Inverter Drives

Equivalent Circuit Schematic

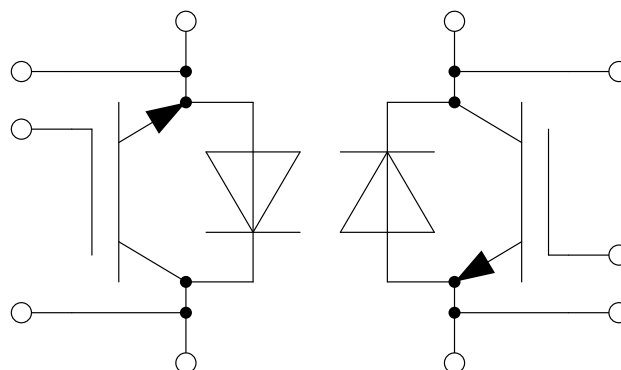

Absolute Maximum Ratings $T_C=25^{\circ}\text{C}$ unless otherwise noted**IGBT**

Symbol	Description	Value	Unit
V_{CES}	Collector-Emitter Voltage	1200	V
V_{GES}	Gate-Emitter Voltage	± 20	V
I_C	Collector Current @ $T_C=25^{\circ}\text{C}$	2230	A
	@ $T_C=100^{\circ}\text{C}$	1200	
I_{CM}	Pulsed Collector Current $t_p=1\text{ms}$	2400	A
P_D	Maximum Power Dissipation @ $T_j=175^{\circ}\text{C}$	8196	W

Diode

Symbol	Description	Value	Unit
V_{RRM}	Repetitive Peak Reverse Voltage	1200	V
I_F	Diode Continuous Forward Current	1200	A
I_{FM}	Diode Maximum Forward Current $t_p=1\text{ms}$	2400	A

Module

Symbol	Description	Value	Unit
T_{jmax}	Maximum Junction Temperature	175	$^{\circ}\text{C}$
T_{jop}	Operating Junction Temperature	-40 to +150	$^{\circ}\text{C}$
T_{STG}	Storage Temperature Range	-40 to +125	$^{\circ}\text{C}$
V_{ISO}	Isolation Voltage RMS, $f=50\text{Hz}$, $t=1\text{min}$	4000	V

IGBT Characteristics $T_c=25^\circ\text{C}$ unless otherwise noted

Symbol	Parameter	Test Conditions	Min.	Typ.	Max.	Unit	
$V_{CE(sat)}$	Collector to Emitter Saturation Voltage	$I_C=1200\text{A}, V_{GE}=15\text{V}, T_j=25^\circ\text{C}$		1.70	2.15	V	
		$I_C=1200\text{A}, V_{GE}=15\text{V}, T_j=125^\circ\text{C}$		1.95			
		$I_C=1200\text{A}, V_{GE}=15\text{V}, T_j=150^\circ\text{C}$		2.00			
$V_{GE(th)}$	Gate-Emitter Threshold Voltage	$I_C=30.0\text{mA}, V_{CE}=V_{GE}, T_j=25^\circ\text{C}$	5.2	6.0	6.8	V	
I_{CES}	Collector Cut-Off Current	$V_{CE}=V_{CES}, V_{GE}=0\text{V}, T_j=25^\circ\text{C}$			1.0	mA	
I_{GES}	Gate-Emitter Leakage Current	$V_{GE}=V_{GES}, V_{CE}=0\text{V}, T_j=25^\circ\text{C}$			400	nA	
R_{Gint}	Internal Gate Resistance			1.6		Ω	
C_{ies}	Input Capacitance	$V_{CE}=25\text{V}, f=1\text{MHz}, V_{GE}=0\text{V}$		84.0		nF	
C_{res}	Reverse Transfer Capacitance				4.80		nF
Q_G	Gate Charge	$V_{GE}=-15\dots+15\text{V}$		10.4		μC	
$t_{d(on)}$	Turn-On Delay Time	$V_{CC}=600\text{V}, I_C=1200\text{A}, R_{Gon}=1.6\Omega, R_{Goff}=0.62\Omega, V_{GE}=\pm 15\text{V}, T_j=25^\circ\text{C}$		439		ns	
t_r	Rise Time			210		ns	
$t_{d(off)}$	Turn-Off Delay Time			948		ns	
t_f	Fall Time			155		ns	
E_{on}	Turn-On Switching Loss			123		mJ	
E_{off}	Turn-Off Switching Loss			206		mJ	
$t_{d(on)}$	Turn-On Delay Time		$V_{CC}=600\text{V}, I_C=1200\text{A}, R_{Gon}=1.6\Omega, R_{Goff}=0.62\Omega, V_{GE}=\pm 15\text{V}, T_j=125^\circ\text{C}$		490		ns
t_r	Rise Time				214		ns
$t_{d(off)}$	Turn-Off Delay Time				1030		ns
t_f	Fall Time				206		ns
E_{on}	Turn-On Switching Loss			166		mJ	
E_{off}	Turn-Off Switching Loss			273		mJ	
$t_{d(on)}$	Turn-On Delay Time	$V_{CC}=600\text{V}, I_C=1200\text{A}, R_{Gon}=1.6\Omega, R_{Goff}=0.62\Omega, V_{GE}=\pm 15\text{V}, T_j=150^\circ\text{C}$			492		ns
t_r	Rise Time				215		ns
$t_{d(off)}$	Turn-Off Delay Time				1082		ns
t_f	Fall Time				216		ns
E_{on}	Turn-On Switching Loss			187		mJ	
E_{off}	Turn-Off Switching Loss			278		mJ	
I_{SC}	SC Data		$t_p \leq 10\mu\text{s}, V_{GE}=15\text{V}, T_j=150^\circ\text{C}, V_{CC}=800\text{V}, V_{CEM} \leq 1200\text{V}$		4800		A

Diode Characteristics $T_c=25^\circ\text{C}$ unless otherwise noted

Symbol	Parameter	Test Conditions	Min.	Typ.	Max.	Unit	
V_F	Diode Forward Voltage	$I_F=1200\text{A}, V_{GE}=0\text{V}, T_j=25^\circ\text{C}$		1.65	2.10	V	
		$I_F=1200\text{A}, V_{GE}=0\text{V}, T_j=125^\circ\text{C}$		1.65			
		$I_F=1200\text{A}, V_{GE}=0\text{V}, T_j=150^\circ\text{C}$		1.65			
Q_r	Recovered Charge	$V_{CC}=600\text{V}, I_F=1200\text{A},$ $-di/dt=5900\text{A}/\mu\text{s}, V_{GE}=\pm 15\text{V},$ $T_j=25^\circ\text{C}$		105		μC	
I_{RM}	Peak Reverse Recovery Current			508		A	
E_{rec}	Reverse Recovery Energy			48		mJ	
Q_r	Recovered Charge			209		μC	
I_{RM}	Peak Reverse Recovery Current		$V_{CC}=600\text{V}, I_F=1200\text{A},$ $-di/dt=5900\text{A}/\mu\text{s}, V_{GE}=\pm 15\text{V},$ $T_j=125^\circ\text{C}$		717		A
E_{rec}	Reverse Recovery Energy				100		mJ
Q_r	Recovered Charge				238		μC
I_{RM}	Peak Reverse Recovery Current		$V_{CC}=600\text{V}, I_F=1200\text{A},$ $-di/dt=5900\text{A}/\mu\text{s}, V_{GE}=\pm 15\text{V},$ $T_j=150^\circ\text{C}$		765		A
E_{rec}	Reverse Recovery Energy				114		mJ

Module Characteristics $T_c=25^\circ\text{C}$ unless otherwise noted

Symbol	Parameter	Min.	Typ.	Max.	Unit
L_{CE}	Stray Inductance		20		nH
$R_{CC'+EE'}$	Module Lead Resistance, Terminal to Chip		0.18		m Ω
R_{thJC}	Junction-to-Case (per IGBT)			18.3	K/kW
	Junction-to-Case (per Diode)			28.3	
R_{thCH}	Case-to-Heatsink (per IGBT)		19.8		K/kW
	Case-to-Heatsink (per Diode)		30.6		
	Case-to-Heatsink (per Module)		6.0		
M	Terminal Connection Torque, Screw M4	1.8		2.1	N.m
	Terminal Connection Torque, Screw M8	8.0		10	
	Mounting Torque, Screw M6	4.25		5.75	
G	Weight of Module		1500		g

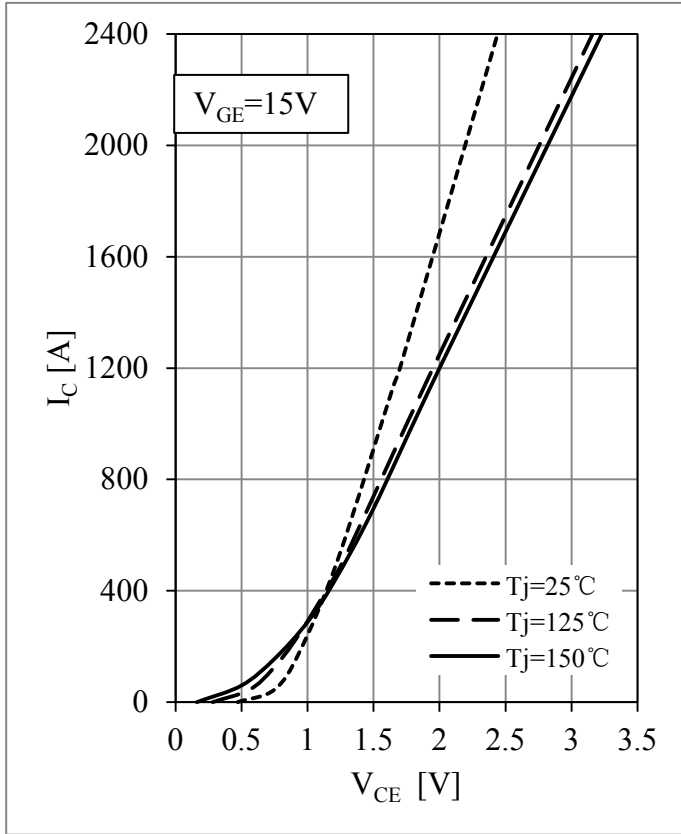

Fig 1. IGBT Output Characteristics

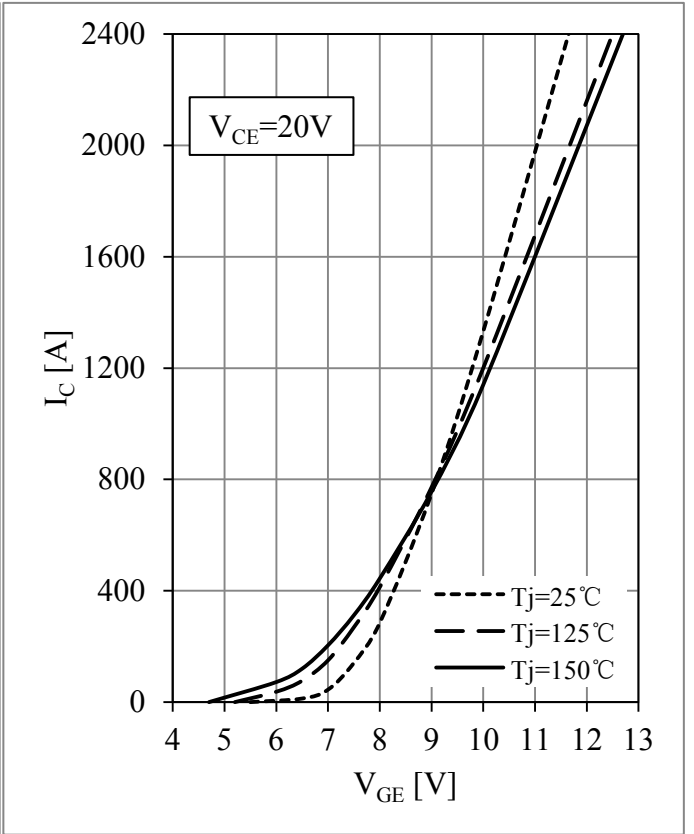

Fig 2. IGBT Transfer Characteristics

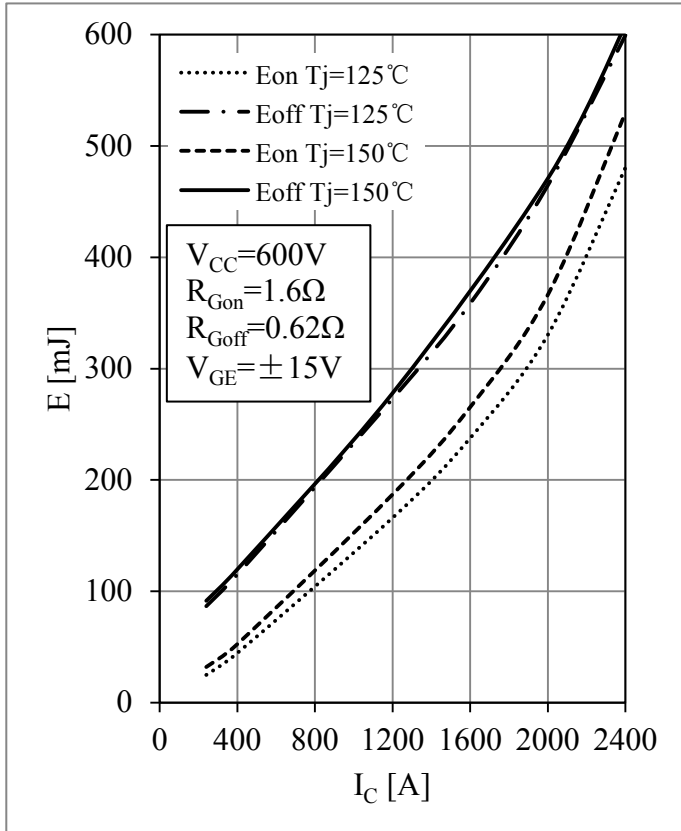

Fig 3. IGBT Switching Loss vs. I_C

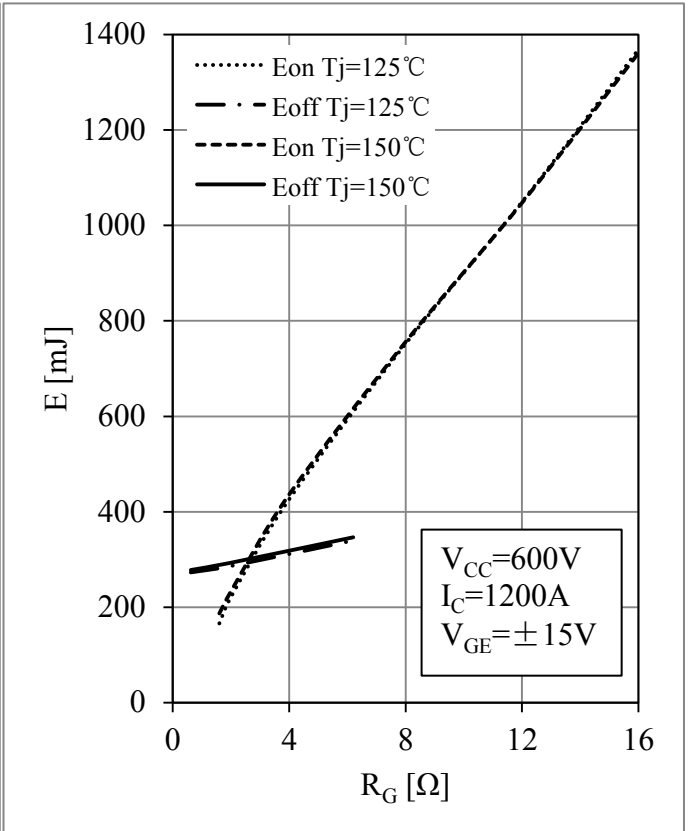

Fig 4. IGBT Switching Loss vs. R_G

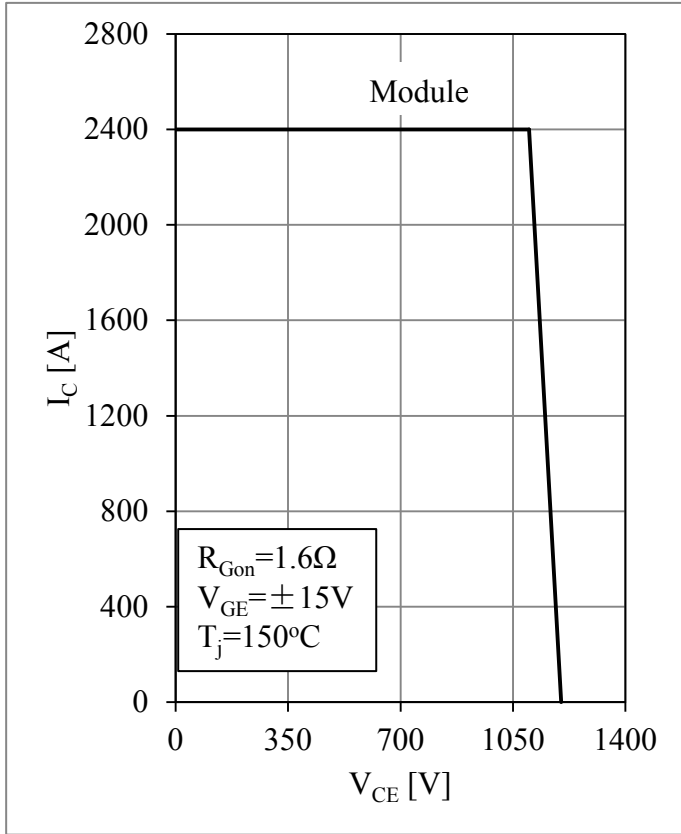

Fig 5. RBSOA

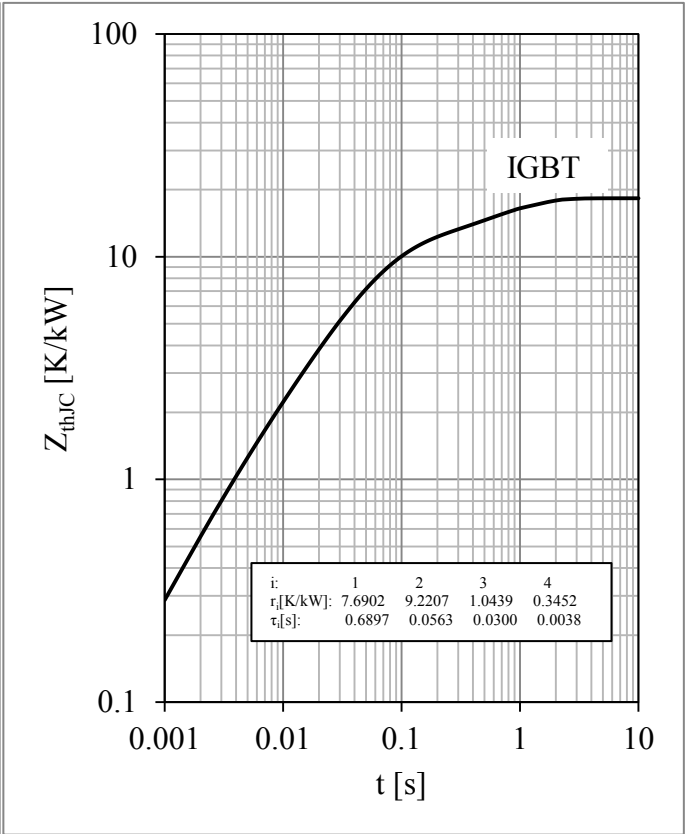

Fig 6. IGBT Transient Thermal Impedance

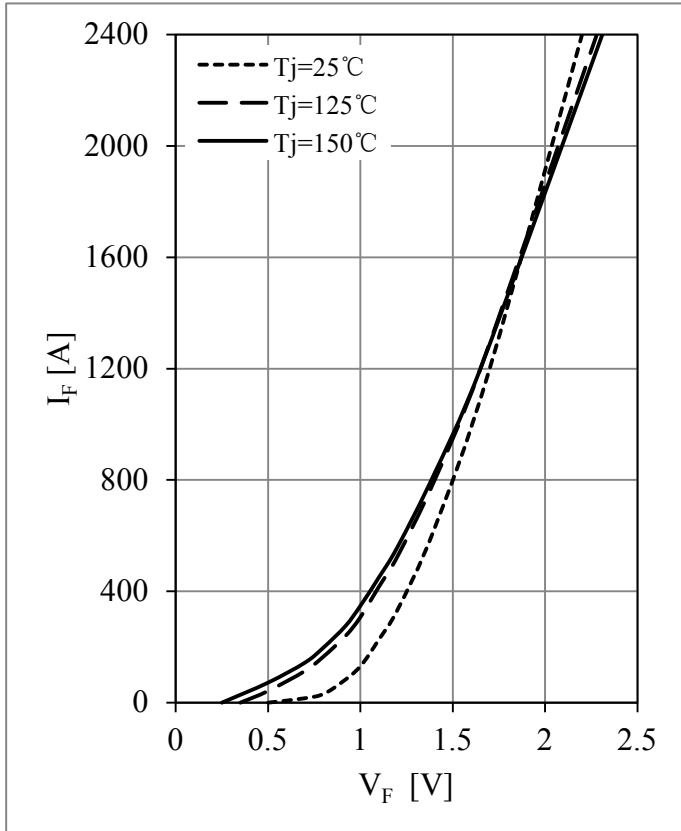

Fig 7. Diode Forward Characteristics

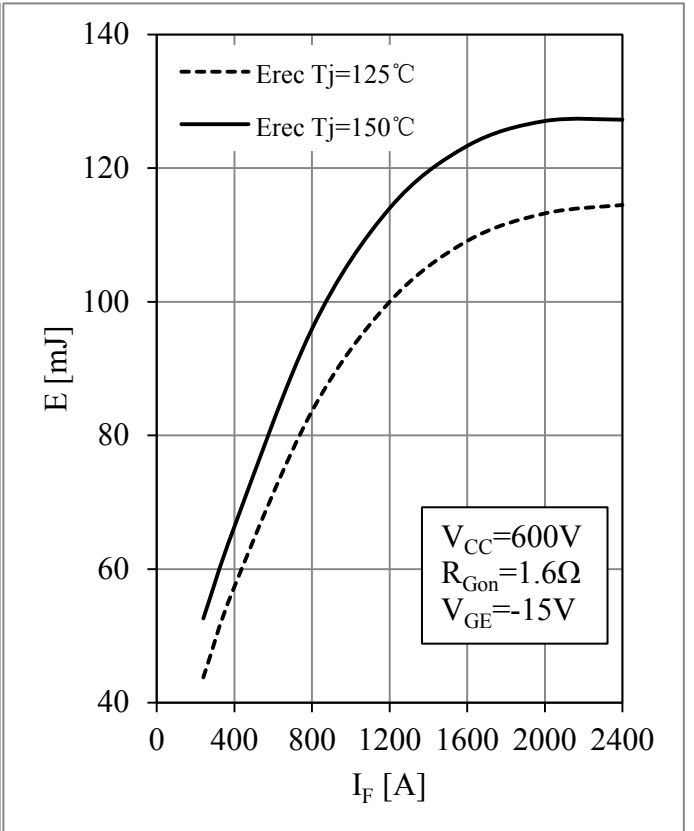

Fig 8. Diode Switching Loss vs. I_F

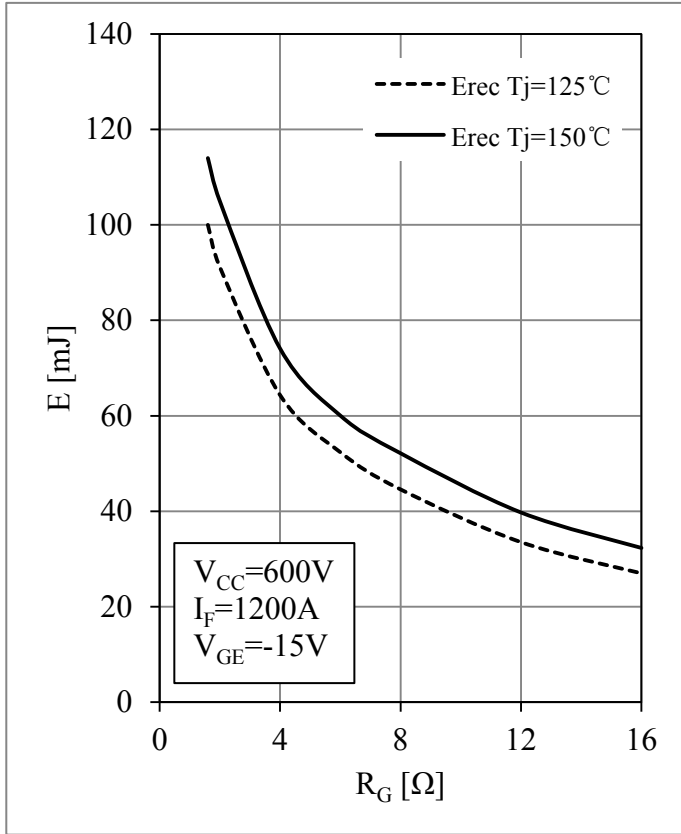

Fig 9. Diode Switching Loss vs. R_G

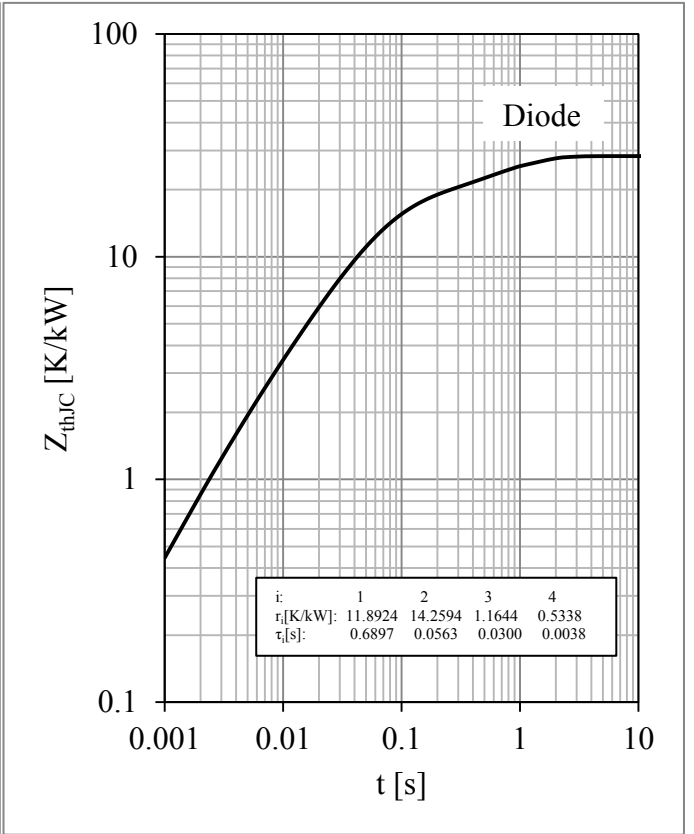
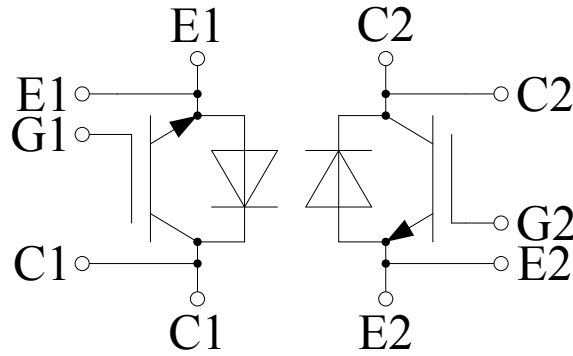

Fig 10. Diode Transient Thermal Impedance

Circuit Schematic



Package Dimensions

Dimensions in Millimeters

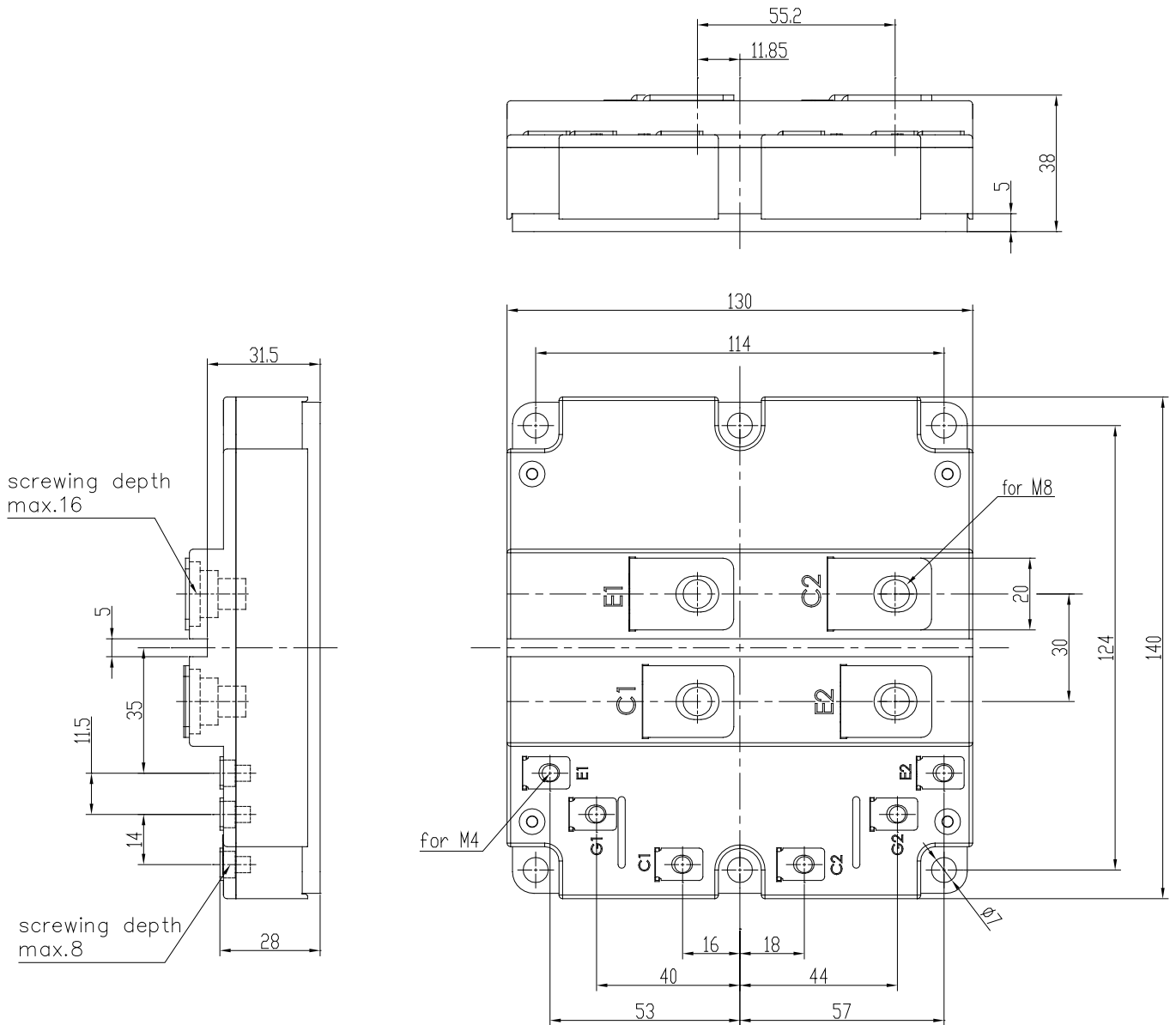

Terms and Conditions of Usage

The data contained in this product datasheet is exclusively intended for technically trained staff. you and your technical departments will have to evaluate the suitability of the product for the intended application and the completeness of the product data with respect to such application.

This product data sheet is describing the characteristics of this product for which a warranty is granted. Any such warranty is granted exclusively pursuant the terms and conditions of the supply agreement. There will be no guarantee of any kind for the product and its characteristics.

Should you require product information in excess of the data given in this product data sheet or which concerns the specific application of our product, please contact the sales office, which is responsible for you (see www.powersemi.cc), For those that are specifically interested we may provide application notes.

Due to technical requirements our product may contain dangerous substances. For information on the types in question please contact the sales office, which is responsible for you.

Should you intend to use the Product in aviation applications, in health or live endangering or life support applications, please notify.

If and to the extent necessary, please forward equivalent notices to your customers.
Changes of this product data sheet are reserved.