

# EMC/EMI Filter for PV Inverters



- Reduces conducted emissions towards the solar panel
- Reduces the probability of EMI radiation off the solar panel
- Helps to prevent pre-mature panel aging because of HF leakage currents
- Helps to meet international EMC regulations for the entire PV system
- Most compact standard solution in the industry, optionally available without capacitors to ground (B types)
- New: up to 2300 A



### Performance indicators

#### Attenuation performance

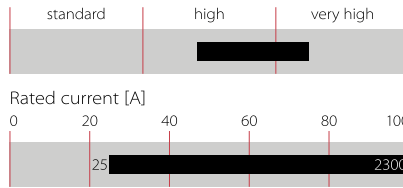

### Approvals & Compliances



FN 2200 are the most compact dedicated DC filters for PV inverters in the industry and therefore support the integration in the ever shrinking frame sizes of today's power electronics. All FN 2200 come in unsymmetrical housings, which help to prevent inverse installation and wrong electrical connection. Along with grid-side installed Schaffner AC EMC/EMI filters, FN 2200 are key to meet the stringent international standards for electromagnetic compatibility (EMC) like EN 61000-6-3 and -6-4 and help to ensure a reliable and fault-free operation of the entire PV system. FN 2200 are designed for very low power loss, to support overall PV system efficiency.

### Features and benefits

FN 2200 range of standard EMC/EMI filters is based on Schaffner's years of experience in custom filter design for the global photovoltaic (PV) inverter industry. Installed between the PV inverter and the solar panel, FN 2200 DC filters help to control conducted emissions on the panel side of the system and therefore significantly reduce the potential for high-frequency (HF) interference radiation off the panel. The filter also protects the solar panel from HF stray and leakage currents which can cause pre-mature aging in the PV modules.

### Typical applications

FN 2200 are primarily designed for PV inverters. However, they can potentially also be used in other DC applications within published specifications, like UPS, DC motor drives, or DC quick chargers.

#### Typical electrical schematic

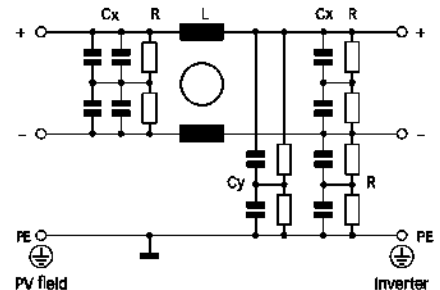



## Technical specifications

- Maximum continuous operating voltage**
- Operating frequency**
- Rated currents**
- High potential test voltage**
- Protection category**
- Overload capability**
- Temperature range (operation and storage)**
- Design corresponding to**
- Flammability corresponding to**
- MTBF @ 55°C/1200 V (Mil-HB-217F)**

- Max. 1200 VDC
- DC
- 25 to 2300 A @ 55°C
- P → E 3600 VDC for 2 sec
- P → P 3000 VDC for 2 sec
- IP 20 (25 to 150 A types); IP 00 (250 to 2300 A types)
- 4x rated current at switch on,
- 1.5x rated current for 1 minute, once per hour
- 40°C to +100°C (40/100/21)
- UL 1283, CSA 22.2 No. 8 1986, IEC/EN 60939
- UL 94 V-2 or better
- min. 223,000 hours

**Filter selection table**

Filter	Rated current @ 55°C (40°C)	Typical inverter AC power rating*	Filter efficiency @ 25°C/DC	Power loss @ 25°C/DC	Input/Output connections	Weight
	[A]	[kW]	[%]	[W]	 	[kg]
FN 2200-25-33	25 (28)	10	> 99.9	8	-33	0.9
FN 2200-50-34	50 (57)	20	> 99.9	17	-34	1.6
FN 2200-75-34	75 (86)	30	> 99.9	18	-34	1.7
FN 2200-100-35	100 (115)	40	> 99.9	22	-35	2.7
FN 2200-150-40	150 (173)	60	> 99.9	31	-40	4.9
FN 2200-250-99	250 (288)	100	> 99.9	10	-99	5.0
FN 2200-400-99	400 (460)	150	> 99.9	16	-99	6.1
FN 2200-600-99	600 (690)	250	> 99.9	29	-99	6.5
FN 2200-800-99	800 (920)	350	> 99.9	26	-99	9.3
FN 2200-1000-99	1000 (1150)	400	> 99.9	40	-99	9.4
FN 2200-1500-99	1500 (1600)	500	> 99.9	45	-99	14.6
FN 2200-2300-99	2300 (2500)	800/1000	> 99.9	84	-99	25.0
FN 2200B-25-33	25 (28)	10	> 99.9	8	-33	0.9
FN 2200B-50-34	50 (57)	20	> 99.9	17	-34	1.6
FN 2200B-75-34	75 (86)	30	> 99.9	18	-34	1.7
FN 2200B-100-35	100 (115)	40	> 99.9	22	-35	2.7
FN 2200B-150-40	150 (173)	60	> 99.9	31	-40	4.9
FN 2200B-250-99	250 (288)	100	> 99.9	10	-99	5.0
FN 2200B-400-99	400 (460)	150	> 99.9	16	-99	6.1
FN 2200B-600-99	600 (690)	250	> 99.9	29	-99	6.5
FN 2200B-800-99	800 (920)	350	> 99.9	26	-99	9.3
FN 2200B-1000-99	1000 (1150)	400	> 99.9	40	-99	9.4
FN 2200B-1500-99	1500 (1600)	500	> 99.9	45	-99	14.6
FN 2200B-2300-99	2300 (2500)	800/1000	> 99.9	84	-99	25.0

\* Based on rated DC current of typical 3-phase PV inverters with 900 VDC input. Note: depending upon manufacturer and model, DC currents for a given PV inverter power can differ significantly. Filters with higher current ratings for large central inverters up to the MW range are available upon request.

**Typical filter attenuation**

Per CISPR 17; A=50 Ω/50 Ω sym; B=50 Ω/50 Ω asym; C=0.1 Ω/100 Ω sym; D=100 Ω/0.1 Ω sym

25 to 75 A types

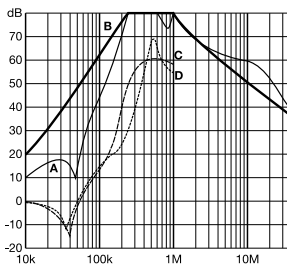

100 to 150 A types

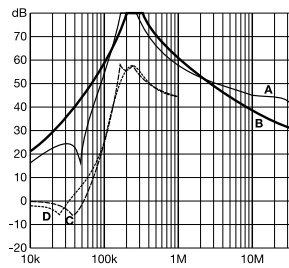

250 A types

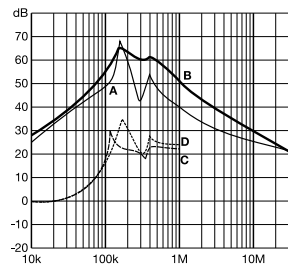

400 to 2300 A types

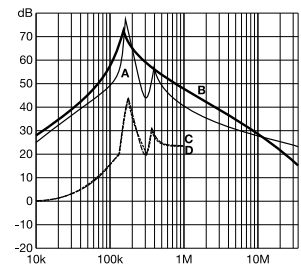

**Typical block schematic**

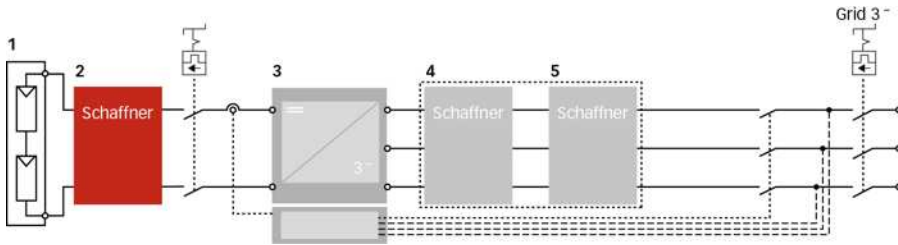

- 1 PV modules
- 2 Schaffner FN 2200
- 3 Central Inverter
- 4 Schaffner magnetic components
- 5 Schaffner AC EMC/EMI filter

**Mechanical data**

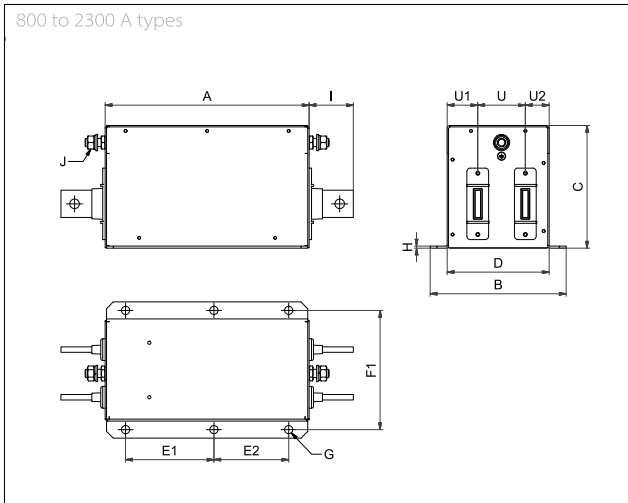
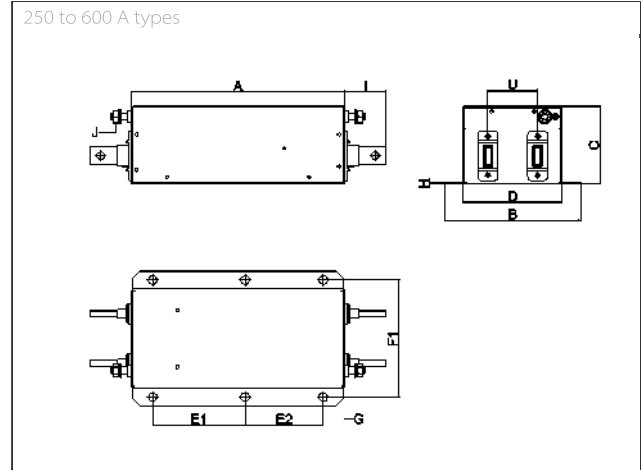
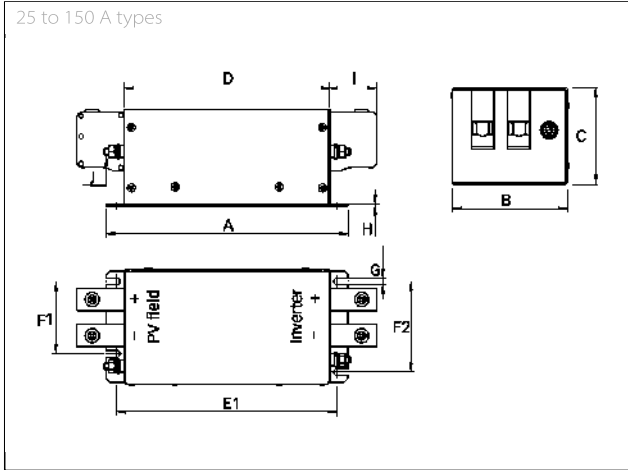

**Note:** all FN 2200 provide unsymmetrical mounting hole patterns to prevent inverse filter installation in the field. (Dimensions E1 E2 and F1/F2)

**Busbar connections**

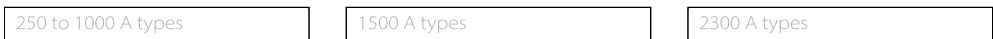

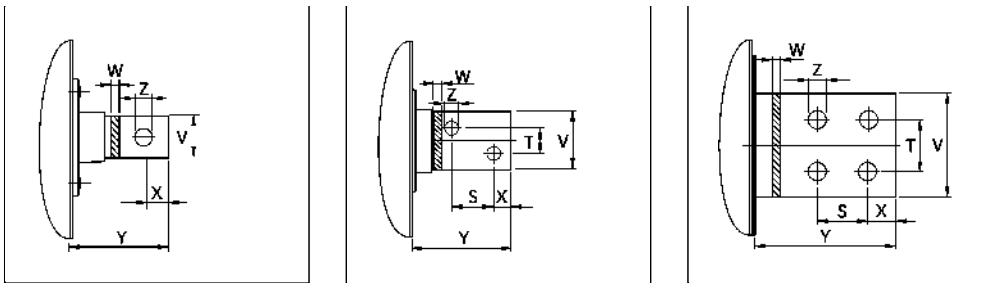

## Dimensions

	25 A	50 A	75 A	100 A	150 A	250 A	400 A	600 A	800 A	1000 A	1500 A	2300 A
<b>A</b>	170	200	200	220	250	300	300	300	300	300	300	400
<b>B</b>	80	95	95	125	140	180	190	190	200	200	200	250
<b>C</b>	65	80	80	95	115	110	110	110	140	140	150	180
<b>D</b>	140	170	170	190	220	130	140	140	150	150	150	195
<b>E1</b>	152.5	182.5	182.5	202.5	232.5	130	130	130	130	130	130	190
<b>E2</b>						110	110	110	110	110	110	150
<b>F1</b>	45	60	60	80	100	155	165	165	175	175	175	225
<b>F2</b>	60	75	75	100	120							
<b>G</b>	5.5	5.5	5.5	5.5	5.5	Ø 12	Ø 12	Ø 12	Ø 12	Ø 12	Ø 12	Ø 12
<b>H</b>	1	1.5	1.5	1.5	2	2	2	2	3	3	3	3
<b>I</b>	25	39	39	45	51	58	58	58	65	65	110	100
<b>J</b>	M5	M6	M6	M8	M10	M10	M10	M10	M12	M12	M12	M16
<b>S</b>											43	35
<b>T</b>											26	35
<b>U</b>						70	70	70	70	70	70	100
<b>U1</b>									45	45	55	61
<b>U2</b>									35	35	25	34
<b>V</b>						20	25	25	40	40	60	70
<b>W</b>						5	6	8	8	8	10	15
<b>X</b>						15	15	15	20	20	17	20
<b>Y</b>						58	58	58	65	65	110	100
<b>Z</b>						Ø 9	Ø 10.5	Ø 10.5	Ø 14	Ø 14	Ø 14	Ø 14

All dimensions in mm; 1 inch = 25.4 mm  
Tolerances according: ISO 2768-m/EN 22768-m

## Filter input/output connector cross sections

	-33	-34	-35	-40
<b>Solid wire</b>	16 mm <sup>2</sup>	35 mm <sup>2</sup>	50 mm <sup>2</sup>	95 mm <sup>2</sup>
<b>Flex wire</b>	10 mm <sup>2</sup>	25 mm <sup>2</sup>	50 mm <sup>2</sup>	95 mm <sup>2</sup>
<b>AWG type wire</b>	AWG 6	AWG 2	AWG 1/0	AWG 4/0
<b>Recommended torque</b>	1.5-1.8 NM	4.0-4.5 NM	7-8 NM	17-20 NM

Please visit [www.schaffner.com](http://www.schaffner.com) to find more details on filter connectors.



**Switzerland****Schaffner Group**

Industrie Nord  
 Nordstrasse 11e  
 4542 Luterbach  
 T +41 32 681 66 26  
[info@schaffner.com](mailto:info@schaffner.com)

To find your local partner within Schaffner's global network: [www.schaffner.com](http://www.schaffner.com)

© 2018 Schaffner Group

The content of this document has been carefully checked and understood. However, neither Schaffner nor its subsidiaries assume any liability whatsoever for any errors or inaccuracies of this document and the consequences thereof. Published specifications are subject to change without notice. Product suitability for any area of application must ultimately be determined by the customer. In all cases, products must never be operated outside their published specifications. Schaffner does not guarantee the availability of all published products. This disclaimer shall be governed by substantive Swiss law and resulting disputes shall be settled by the courts at the place of business of Schaffner Holding AG. Latest publications and a complete disclaimer can be downloaded from the Schaffner website. All trademarks recognized.

**China****Schaffner EMC Ltd. Shanghai**

T20-3 C, No 565 Chuangye Road,  
 Pudong district  
 201201 Shanghai  
 T +86 21 3813 9500  
[cschina@schaffner.com](mailto:cschina@schaffner.com)  
[www.schaffner.com.cn](http://www.schaffner.com.cn)

**Finland****Schaffner Oy**

Sauvonrinne 19 H  
 08500 Lohja  
 T +358 10 567 2855  
[finlandsales@schaffner.com](mailto:finlandsales@schaffner.com)

**France****Schaffner EMC S.A.S.**

16-20 Rue Louis Rameau  
 95875 Bezons  
 T +33 1 34 34 30 60  
 F +33 1 39 47 02 28  
[francesales@schaffner.com](mailto:francesales@schaffner.com)

**Germany****Schaffner Deutschland GmbH**

Schoemperlenstrasse 12B  
 76185 Karlsruhe  
 T +49 721 56910  
 F +49 721 569110  
[germanysales@schaffner.com](mailto:germanysales@schaffner.com)

**India****Schaffner India Pvt. Ltd**

REGUS WORLD TRADE CENTRE  
 WTC, 22nd Floor Unit No 2238, Brigade Gateway  
 Campus, 26/1, Dr. Rajkumar Road Malleshwaram  
 (W)  
 560055 Bangalore  
 T +91 80 67935355  
[indiasales@schaffner.com](mailto:indiasales@schaffner.com)

**Italy****Schaffner EMC S.r.l.**

Via Ticino, 30  
 20900 Monza (MB)  
 T +39 039 21 41 070  
[italysales@schaffner.com](mailto:italysales@schaffner.com)

**Japan****Schaffner EMC K.K.**

Taiju-Seimei Sangenjaya Bldg.  
 1-32-12, Kamiyama, Setagaya-ku  
 154-0011 Tokyo  
 T +81 3 5712 3650  
 F +81 3 5712 3651  
[japansales@schaffner.com](mailto:japansales@schaffner.com)  
[www.schaffner.jp](http://www.schaffner.jp)

**Singapore****Schaffner EMC Pte Ltd.**

#05-09, Kg Ubi Ind. Estate  
 408705 Singapore  
 T +65 6377 3283  
 F +65 6377 3281  
[singaporesales@schaffner.com](mailto:singaporesales@schaffner.com)

**Spain****Schaffner EMC España**

Calle Caléndula 93, Miniparc III, Edificio E  
 El Soto de Moraleja, Alcobendas  
 28109 Madrid  
 T +34 917 912 900  
 F +34 917 912 901  
[spainsales@schaffner.com](mailto:spainsales@schaffner.com)

**Sweden****Schaffner EMC AB**

Östermalmstorg 1  
 114 42 Stockholm  
 T +46 8 5050 2425  
[swedensales@schaffner.com](mailto:swedensales@schaffner.com)  
[www.schaffner.com](http://www.schaffner.com)

**Switzerland****Schaffner EMV AG**

Industrie Nord  
 Nordstrasse 11e  
 4542 Luterbach  
 T +41 32 681 66 26  
[switzerlandsales@schaffner.com](mailto:switzerlandsales@schaffner.com)

**Taiwan R.O.C.****Schaffner EMV Ltd.**

20 Floor-2, No 97, Section 1, XinTai 5th Road  
 22175 XiZhi District New Taipei City 22175  
 T +886 2 2697 5500  
 F +886 2 2697 5533  
[taiwansales@schaffner.com](mailto:taiwansales@schaffner.com)  
[www.schaffner.com.tw](http://www.schaffner.com.tw)

**Thailand****Schaffner EMC Co. Ltd.**

Northern Region Industrial Estate  
 67 Moo 4 Tambon Ban Klang  
 Amphur Muangng P.O. Box 14  
 51000 Lamphun  
 T +66 53 58 11 04  
 F +66 53 58 10 19  
[thailandsales@schaffner.com](mailto:thailandsales@schaffner.com)

**United Kingdom****Schaffner Ltd.**

1, Oakmede Place  
 Binfield  
 RG42 4JF Berkshire  
 T +44 118 9770070  
 F +44 118 9792969  
[uksales@schaffner.com](mailto:uksales@schaffner.com)

**USA****Schaffner EMC Inc.**

52 Mayfield Avenue  
 Edison, New Jersey  
 T +1 732 225 9533  
 F +1 732 225 4789  
[usasales@schaffner.com](mailto:usasales@schaffner.com)  
[www.schaffnerusa.com](http://www.schaffnerusa.com)

**Schaffner North America**

6722 Thirlane Road  
 24019 Roanoke, Virginia  
 T +1 276 228 7943  
 F +1 276 228 7953

**Schaffner North America**

823 Fairview Road  
 24382 Wytheville, Virginia  
 T +1 276 228 7943  
 F +1 276 228 7258