

- > Sub-base mounted, ISO 5599-1 sizes 1, 2 or 3
- > Specially coated glandless spool and sleeve for long trouble-free life
- > Integral flow regulators available on ISO 1 and 2 sizes for cylinder speed control
- > Low power solenoids feature
- > Manual override as standard
- > Impulse actuated bistable valve with detent mechanism
- > Wide range of sub-bases and accessories

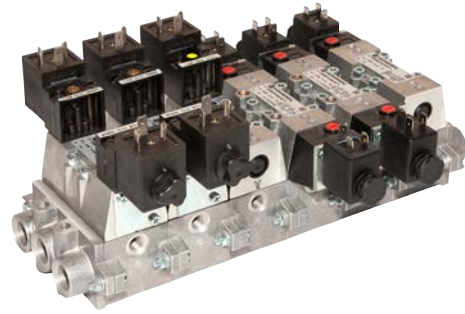

### Technical features

**Medium:**

Compressed air, 40 µm filtered, lubricated or non-lubricated

**Operation:**

Glandless spool valve, solenoid pilot or air pilot actuated

**Mounting:**

On sub-bases

**Sizes:**

ISO 1, 2 and 3

**Maximum operating pressure:**

Solenoid valves; 10 (145 psi) or 16 bar (232 psi)

depending on solenoid pilot operator

Air pilot operated valves; 16 bar (232 psi)

Refer to technical specification table for details

**Ambient/Media temperature:**

Solenoid pilot actuated valves

-15 ... +50°C (+5 ... 122°F)

Air pilot actuated valves

-15 ... +80°C (+5 ... 176°F)

Air supply must be dry enough to avoid ice formation at temperatures below +2°C (+35°F).

**Materials:**

Body: die-cast aluminium

Spool & sleeve: hard anodised aluminium with special PTFE coating

Seals: NBR

Locking plate: die-cast zinc or steel

blue zinc coated

Screws: steel, blue zinc coated

Plastic parts: POM

Flow regulators: brass

### Electrical details for solenoid operators

<b>Voltage tolerance</b>	± 10%		
<b>Rating</b>	100% continuous duty		
<b>Inlet orifice</b>	1,0 mm		
<b>Electrical connection (corresponding to chosen coil)</b>	EN 175301-803 - Form A, 30 mm		
	EN 175301-803 - Form B, 22 mm		
	Industrial Standard, 22 mm		
<b>Solenoid coil mounting</b>	Four positions x 90°		
<b>Manual override</b>	End solenoid models	Push and turn to lock (plastic)	# = 0
		Push only (plastic)	# = 1
	CNOMO solenoid models	Push and turn to lock (plastic)	# = 0
		Push only (brass)	# = 1
<b>Protection class</b>	IP 65 (with sealed plug)		

5/2 Solenoid pilot actuated valves - 10 bar solenoid pilot pressure

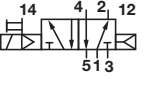
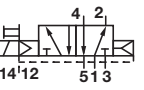
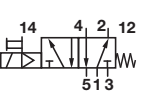
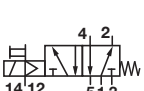
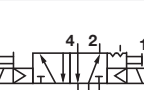
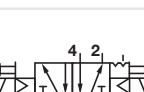
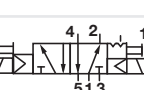
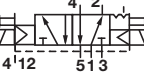
Symbol	ISO size	Flow regulator	Actuation	Pilot supply	Flow (l/min)	Operating pressure (bar)	Pilot pressure (bar)	Weight (kg)	Drawing No.	Model End solenoid actuated valves	CNOMO solenoid actuated valves
	1	—	Solenoid/air spring	Internal	1230	1 ... 10	—	0,33	1 & 3	SXE9573-A70-0#-*1)	SXE9573-Z70-6#-*1)
	2	—	Solenoid/air spring	Internal	2450	1 ... 10	—	0,59	1 & 3	SXE9574-A70-0#-*1)	SXE9574-Z70-6#-*1)
	3	—	Solenoid/air spring	Internal	4400	1 ... 10	—	0,85	1 & 3	SXE9575-A70-0#-*1)	SXE9575-Z70-6#-*1)
	1	Built-in	Solenoid/air spring	Internal	1230	1 ... 10	—	0,33	1 & 3	SXE9573-A80-0#-*1)	SXE9573-Z80-6#-*1)
	2	Built-in	Solenoid/air spring	Internal	2450	1 ... 10	—	0,59	1 & 3	SXE9574-A80-0#-*1)	SXE9574-Z80-6#-*1)
	1	—	Solenoid/air spring	External *3)	1230	-0,9 ... 16	1 ... 10	0,33	1 & 3	SXE9573-A75-0#-*1)	SXE9573-Z75-6#-*1)
	1	Built-in	Solenoid/air spring	External *3)	1230	-0,9 ... 16	1 ... 10	0,33	1 & 3	SXE9573-A85-0#-*1)	SXE9573-Z85-6#-*1)
	2	—	Solenoid/air spring	External *3)	2450	-0,9 ... 16	1 ... 10	0,59	1 & 3	SXE9574-A75-0#-*1)	SXE9574-Z75-6#-*1)
	3	—	Solenoid/air spring	External *3)	4400	-0,9 ... 16	1 ... 10	0,85	1 & 3	SXE9575-A75-0#-*1)	SXE9575-Z75-6#-*1)
	2	Built-in	Solenoid/air spring	External *3)	2450	-0,9 ... 16	1 ... 10	0,59	1 & 3	SXE9574-A85-0#-*1)	SXE9574-Z85-6#-*1)
	1	—	Solenoid/spring	Internal	1230	1,8 ... 10	—	0,33	1 & 3	SXE9573-A71-0#-*1)	SXE9573-Z71-6#-*1)
	2	—	Solenoid/spring	Internal	2450	1,8 ... 10	—	0,59	1 & 3	SXE9574-A71-0#-*1)	SXE9574-Z71-6#-*1)
	3	—	Solenoid/spring	Internal	4400	1,8 ... 10	—	0,85	1 & 3	SXE9575-A71-0#-*1)	SXE9575-Z71-6#-*1)
	1	Built-in	Solenoid/spring	Internal	1230	1,8 ... 10	—	0,33	1 & 3	SXE9573-A81-0#-*1)	SXE9573-Z81-6#-*1)
	2	Built-in	Solenoid/spring	Internal	2450	1,8 ... 10	—	0,59	1 & 3	SXE9574-A81-0#-*1)	SXE9574-Z81-6#-*1)
	1	—	Solenoid/spring	External *3)	1230	-0,9 ... 16	1,8 ... 10	0,33	1 & 3	SXE9573-A76-0#-*1)	SXE9573-Z76-6#-*1)
	2	—	Solenoid/spring	External *3)	2450	-0,9 ... 16	1,8 ... 10	0,59	1 & 3	SXE9574-A76-0#-*1)	SXE9574-Z76-6#-*1)
	3	—	Solenoid/spring	External *3)	4400	-0,9 ... 16	1,8 ... 10	0,85	1 & 3	SXE9575-A76-0#-*1)	SXE9575-Z76-6#-*1)
	1	Built-in	Solenoid/spring	External *3)	1230	-0,9 ... 16	1,8 ... 10	0,33	1 & 3	SXE9573-A86-0#-*1)	SXE9573-Z86-6#-*1)
	2	Built-in	Solenoid/spring	External *3)	2450	-0,9 ... 16	1,8 ... 10	0,59	1 & 3	SXE9574-A86-0#-*1)	SXE9574-Z86-6#-*1)
	1	—	Solenoid/solenoid	Internal	1230	2 ... 10	—	0,45	2 & 4	SXE0573-A50-0#-*1)	SXE0573-Z50-6#-*1)
	2	—	Solenoid/solenoid	Internal	2450	2 ... 10	—	0,72	2 & 4	SXE0574-A50-0#-*1)	SXE0574-Z50-6#-*1)
	3	—	Solenoid/solenoid	Internal	4400	2 ... 10	—	0,96	2 & 4	SXE0575-A50-0#-*1)	SXE0575-Z50-6#-*1)
	1	Built-in	Solenoid/solenoid	Internal	1230	2 ... 10	—	0,45	2 & 4	SXE0573-A60-0#-*1)	SXE0573-Z60-6#-*1)
	2	Built-in	Solenoid/solenoid	Internal	2450	2 ... 10	—	0,72	2 & 4	SXE0574-A60-0#-*1)	SXE0574-Z60-6#-*1)
	1	—	Solenoid/solenoid	External *3)	1230	-0,9 ... 16	2 ... 10	0,45	2 & 4	SXE0573-A55-0#-*1)	SXE0573-Z55-6#-*1)
	2	—	Solenoid/solenoid	External *3)	2450	-0,9 ... 16	2 ... 10	0,72	2 & 4	SXE0574-A55-0#-*1)	SXE0574-Z55-6#-*1)
	3	—	Solenoid/solenoid	External *3)	4400	-0,9 ... 16	2 ... 10	0,96	2 & 4	SXE0575-A55-0#-*1)	SXE0575-Z55-6#-*1)
	1	Built-in	Solenoid/solenoid	External *3)	1230	-0,9 ... 16	2 ... 10	0,45	2 & 4	SXE0573-A65-0#-*1)	SXE0573-Z65-6#-*1)
	2	Built-in	Solenoid/solenoid	External *3)	2450	-0,9 ... 16	2 ... 10	0,72	2 & 4	SXE0574-A65-0#-*1)	SXE0574-Z65-6#-*1)
	1	—	Solenoid/solenoid *2)	Internal	1230	2 ... 10	—	0,45	2 & 4	—	SXE1573-Z50-6#-*1)
	2	—	Solenoid/solenoid *2)	Internal	2450	2 ... 10	—	0,72	2 & 4	—	SXE1574-Z50-6#-*1)
	3	—	Solenoid/solenoid *2)	Internal	4400	2 ... 10	—	0,96	2 & 4	—	SXE1575-Z50-6#-*1)
	1	—	Solenoid/solenoid *2)	External *3)	1230	-0,9 ... 16	2 ... 10	0,45	2 & 4	—	SXE1573-Z55-6#-*1)
	2	—	Solenoid/solenoid *2)	External *3)	2450	-0,9 ... 16	2 ... 10	0,72	2 & 4	—	SXE1574-Z55-6#-*1)
	3	—	Solenoid/solenoid *2)	External *3)	4400	-0,9 ... 16	2 ... 10	0,96	2 & 4	—	SXE1575-Z55-6#-*1)

# Insert code for manual override: 0 = push and turn (standard - End solenoid), 1 = push only

\*1) Insert voltage code from tables below or without coil; SXE\*\*7\*-A\*-00K (end solenoid) or SXE\*\*7\*-Z\*\*-6\*K (CNOMO solenoid)

\*2) Pilot side 14 priority

\*3) External pilot supply for ISO1 at port 14 only; ISO2 and ISO3 at port 12 or 14 (unconnected port 12 or 14 has to be plugged).

Voltage codes and spare coils for 10 bar models (End & CNOMO solenoid operator)

22 mm coil for connector interface acc. to industrial standard

Voltage	Power Inrush/Hold	Model	Code
12 V d.c.	2 W	QM/48/12J/21	12J
24 V d.c.	2 W	QM/48/13J/21	13J
24 V 50/60 Hz	4/2,5 VA	QM/48/14J/21	14J
48 V 50/60 Hz	4/2,5 VA	QM/48/16J/21	16J
110/120 V 50/60 Hz	4/2,5 VA	QM/48/18J/21	18J
220/240 V 50/60 Hz	6/5,0 VA	QM/48/19J/21	19J



22 mm coil for connector interface acc. EN 175 301-803, form B

Voltage	Power Inrush/Hold	Model	Code
12 V d.c.	2 W	V10626-A12L	12L
24 V d.c.	2 W	V10626-A13L	13L
24 V 50/60 Hz	4/2,5 VA	V10626-A14L	14L
48 V 50/60 Hz	4/2,5 VA	V10626-A16L	16L
110/120 V 50/60 Hz	4/2,5 VA	V10626-A18L	18L
220/240 V 50/60 Hz	6/5,0 VA	V10626-A19L	19L



30 mm coil for connector interface acc. EN 175 301-803, form A





Voltage	Power Inrush/Hold	Model	Code
12 V d.c.	1,5 W	V10633-A22N	22N
24 V d.c.	1,5 W	V10633-A23N	23N
24 V 50/60 Hz	3/2 VA	V10633-A24N	24N
48 V 50/60 Hz	3/2 VA	V10633-A26N	26N
110/120 V 50/60 Hz	3/2 VA	V10633-A28N	28N
220/240 V 50/60 Hz	3/2 VA	V10633-A29N	29N

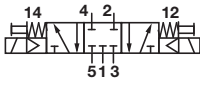
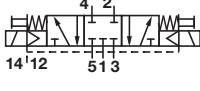

Connector plugs - ordered separately

Industrial standard 22 mm 2-pole + PE	22 mm, EN 175301-803 (DIN 43650 B) Form B 2-pole + PE	30 mm, EN 175301-803 (DIN 43650 B) Form A 2-pole + PE
		
0657868	0680003	0570275

**5/3 Solenoid pilot actuated valves - 10 bar solenoid pilot pressure**

Symbol	ISO size	Flow regulator	Actuation	Function	Pilot supply	Flow (l/min)	Operating pressure (bar)	Pilot pressure (bar)	Weight (kg)	Drawing No.	Model End solenoid actuated valves	CNOMO solenoid actuated valves
	1	—	Solenoid/solenoid	APB	Internal	1320	2 ... 10	—	0,45	2 & 4	SXE9673-A50-0#-*1)	SXE9673-Z50-6#-*1)
	2	—	Solenoid/solenoid	APB	Internal	2520	2 ... 10	—	0,72	2 & 4	SXE9674-A50-0#-*1)	SXE9674-Z50-6#-*1)
	3	—	Solenoid/solenoid	APB	Internal	4650	2 ... 10	—	0,96	2 & 4	SXE9675-A50-0#-*1)	SXE9675-Z50-6#-*1)
	1	Built-in	Solenoid/solenoid	APB	Internal	1320	2 ... 10	—	0,45	2 & 4	SXE9673-A60-0#-*1)	SXE9673-Z60-6#-*1)
	2	Built-in	Solenoid/solenoid	APB	Internal	2520	2 ... 10	—	0,72	2 & 4	SXE9674-A60-0#-*1)	SXE9674-Z60-6#-*1)
	2	Built-in	Solenoid/solenoid	APB	Internal	2520	2 ... 10	—	0,72	2 & 4	SXE9674-A60-0#-*1)	SXE9674-Z60-6#-*1)
	1	—	Solenoid/solenoid	APB	External *3)	1320	-0,9 ... 16	2 ... 10	0,45	2 & 4	SXE9673-A55-0#-*1)	SXE9673-Z55-6#-*1)
	2	—	Solenoid/solenoid	APB	External *3)	2520	-0,9 ... 16	2 ... 10	0,72	2 & 4	SXE9674-A55-0#-*1)	SXE9674-Z55-6#-*1)
	3	—	Solenoid/solenoid	APB	External *3)	4650	-0,9 ... 16	2 ... 10	0,96	2 & 4	SXE9675-A55-0#-*1)	SXE9675-Z55-6#-*1)
	1	Built-in	Solenoid/solenoid	APB	External *3)	1320	-0,9 ... 16	2 ... 10	0,45	2 & 4	SXE9673-A65-0#-*1)	SXE9673-Z65-6#-*1)
	2	Built-in	Solenoid/solenoid	APB	External *3)	2520	-0,9 ... 16	2 ... 10	0,72	2 & 4	SXE9674-A65-0#-*1)	SXE9674-Z65-6#-*1)
	2	Built-in	Solenoid/solenoid	APB	External *3)	2520	-0,9 ... 16	2 ... 10	0,72	2 & 4	SXE9674-A65-0#-*1)	SXE9674-Z65-6#-*1)
	1	—	Solenoid/solenoid	COE	Internal	1320	2 ... 10	—	0,45	2 & 4	SXE9773-A50-0#-*1)	SXE9773-Z50-6#-*1)
	2	—	Solenoid/solenoid	COE	Internal	2520	2 ... 10	—	0,72	2 & 4	SXE9774-A50-0#-*1)	SXE9774-Z50-6#-*1)
	3	—	Solenoid/solenoid	COE	Internal	4650	2 ... 10	—	0,96	2 & 4	SXE9775-A50-0#-*1)	SXE9775-Z50-6#-*1)
	1	Built-in	Solenoid/solenoid	COE	Internal	1320	2 ... 10	—	0,45	2 & 4	SXE9773-A60-0#-*1)	SXE9773-Z60-6#-*1)
	2	Built-in	Solenoid/solenoid	COE	Internal	2520	2 ... 10	—	0,72	2 & 4	SXE9774-A60-0#-*1)	SXE9774-Z60-6#-*1)
	2	Built-in	Solenoid/solenoid	COE	Internal	2520	2 ... 10	—	0,72	2 & 4	SXE9774-A60-0#-*1)	SXE9774-Z60-6#-*1)
	1	—	Solenoid/solenoid	COE	External *3)	1320	-0,9 ... 16	2 ... 10	0,45	2 & 4	SXE9773-A55-0#-*1)	SXE9773-Z55-6#-*1)
	2	—	Solenoid/solenoid	COE	External *3)	2520	-0,9 ... 16	2 ... 10	0,72	2 & 4	SXE9774-A55-0#-*1)	SXE9774-Z55-6#-*1)
	3	—	Solenoid/solenoid	COE	External *3)	4650	-0,9 ... 16	2 ... 10	0,96	2 & 4	SXE9775-A55-0#-*1)	SXE9775-Z55-6#-*1)
	1	Built-in	Solenoid/solenoid	COE	External *3)	1320	-0,9 ... 16	2 ... 10	0,45	2 & 4	SXE9673-A65-0#-*1)	SXE9773-Z65-6#-*1)
	2	Built-in	Solenoid/solenoid	COE	External *3)	2520	-0,9 ... 16	2 ... 10	0,72	2 & 4	SXE9674-A65-0#-*1)	SXE9774-Z65-6#-*1)
	2	Built-in	Solenoid/solenoid	COE	External *3)	2520	-0,9 ... 16	2 ... 10	0,72	2 & 4	SXE9674-A65-0#-*1)	SXE9774-Z65-6#-*1)
	1	—	Solenoid/solenoid	COP	Internal	1320	2 ... 10	—	0,45	2 & 4	SXE9873-A50-0#-*1)	SXE9873-Z50-6#-*1)
	2	—	Solenoid/solenoid	COP	Internal	2520	2 ... 10	—	0,72	2 & 4	SXE9874-A50-0#-*1)	SXE9874-Z50-6#-*1)
	3	—	Solenoid/solenoid	COP	Internal	4650	2 ... 10	—	0,96	2 & 4	SXE9875-A50-0#-*1)	SXE9875-Z50-6#-*1)
	1	Built-in	Solenoid/solenoid	COP	Internal	1320	2 ... 10	—	0,45	2 & 4	SXE9873-A60-0#-*1)	SXE9873-Z60-6#-*1)
	2	Built-in	Solenoid/solenoid	COP	Internal	2520	2 ... 10	—	0,72	2 & 4	SXE9874-A60-0#-*1)	SXE9874-Z60-6#-*1)
	2	Built-in	Solenoid/solenoid	COP	Internal	2520	2 ... 10	—	0,72	2 & 4	SXE9874-A60-0#-*1)	SXE9874-Z60-6#-*1)
	1	—	Solenoid/solenoid	COP	External *3)	1320	-0,9 ... 16	2 ... 10	0,45	2 & 4	SXE9873-A55-0#-*1)	SXE9873-Z55-6#-*1)
	2	—	Solenoid/solenoid	COP	External *3)	2520	-0,9 ... 16	2 ... 10	0,72	2 & 4	SXE9874-A55-0#-*1)	SXE9874-Z55-6#-*1)
	3	—	Solenoid/solenoid	COP	External *3)	4650	-0,9 ... 16	2 ... 10	0,96	2 & 4	SXE9875-A55-0#-*1)	SXE9875-Z55-6#-*1)
	1	Built-in	Solenoid/solenoid	COP	External *3)	1320	-0,9 ... 16	2 ... 10	0,45	2 & 4	SXE9873-A65-0#-*1)	SXE9873-Z65-6#-*1)
	2	Built-in	Solenoid/solenoid	COP	External *3)	2520	-0,9 ... 16	2 ... 10	0,72	2 & 4	SXE9874-A65-0#-*1)	SXE9874-Z65-6#-*1)
	2	Built-in	Solenoid/solenoid	COP	External *3)	2520	-0,9 ... 16	2 ... 10	0,72	2 & 4	SXE9874-A65-0#-*1)	SXE9874-Z65-6#-*1)



# Insert code for manual override: 0 = push and turn (standard - End solenoid), 1 = push only

\*1) Insert voltage code from tables below or without coil; SXE\*\*7\*-A\*\*-00K (end solenoid) or SXE\*\*7\*-Z\*\*-6\*K (CNOMO solenoid)

\*3) External pilot supply for ISO1 at port 14 only; ISO2 and ISO3 at port 12 or 14 (unconnected port 12 or 14 has to be plugged).

Valve function:  
 APB = All Ports Blocked  
 COE = Centre Open Exhaust  
 COP = Centre Open Pressure

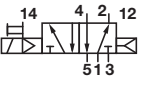
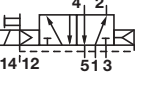
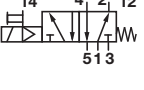
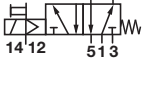
5/2 Solenoid pilot actuated valves – 16 bar solenoid solenoid pilot pressure

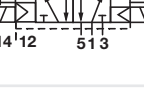
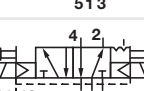
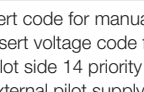
Symbol	ISO size	Flow regulator	Actuation	Pilot supply	Flow (l/min)	Operating pressure (bar)	Pilot pressure (bar)	Weight (kg)	Drawing No.	Model CNOMO solenoid actuated valves
	1	—	Solenoid/air spring	Internal	1230	1 ... 16	—	0,33	1 & 3	SXE9573-Z70-8#-*1)
	2	—	Solenoid/air spring	Internal	2450	1 ... 16	—	0,59	1 & 3	SXE9574-Z70-8#-*1)
	3	—	Solenoid/air spring	Internal	4400	1 ... 16	—	0,85	1 & 3	SXE9575-Z70-8#-*1)
	1	Built-in	Solenoid/air spring	Internal	1230	1 ... 16	—	0,33	1 & 3	SXE9573-Z80-8#-*1)
	2	Built-in	Solenoid/air spring	Internal	2450	1 ... 16	—	0,59	1 & 3	SXE9574-Z80-8#-*1)
	3	Built-in	Solenoid/air spring	Internal	4400	1 ... 16	—	0,85	1 & 3	SXE9575-Z80-8#-*1)
	1	—	Solenoid/air spring	External *3)	1230	-0,9 ... 16	1 ... 16	0,33	1 & 3	SXE9573-Z75-8#-*1)
	1	Built-in	Solenoid/air spring	External *3)	1230	-0,9 ... 16	1 ... 16	0,33	1 & 3	SXE9573-Z85-8#-*1)
	2	—	Solenoid/air spring	External *3)	2450	-0,9 ... 16	1 ... 16	0,59	1 & 3	SXE9574-Z75-8#-*1)
	3	—	Solenoid/air spring	External *3)	4400	-0,9 ... 16	1 ... 16	0,85	1 & 3	SXE9575-Z75-8#-*1)
	2	Built-in	Solenoid/air spring	External *3)	2450	-0,9 ... 16	1 ... 16	0,59	1 & 3	SXE9574-Z85-8#-*1)
	3	Built-in	Solenoid/air spring	External *3)	4400	-0,9 ... 16	1 ... 16	0,85	1 & 3	SXE9575-Z85-8#-*1)
	1	—	Solenoid/spring	Internal	1230	1,8 ... 16	—	0,33	1 & 3	SXE9573-Z71-8#-*1)
	2	—	Solenoid/spring	Internal	2450	1,8 ... 16	—	0,59	1 & 3	SXE9574-Z71-8#-*1)
	3	—	Solenoid/spring	Internal	4400	1,8 ... 16	—	0,85	1 & 3	SXE9575-Z71-8#-*1)
	1	Built-in	Solenoid/spring	Internal	1230	1,8 ... 16	—	0,33	1 & 3	SXE9573-Z81-8#-*1)
	2	Built-in	Solenoid/spring	Internal	2450	1,8 ... 16	—	0,59	1 & 3	SXE9574-Z81-8#-*1)
	3	Built-in	Solenoid/spring	Internal	4400	1,8 ... 16	—	0,85	1 & 3	SXE9575-Z81-8#-*1)
	1	—	Solenoid/spring	External *3)	1230	-0,9 ... 16	1,8 ... 16	0,33	1 & 3	SXE9573-Z76-8#-*1)
	2	—	Solenoid/spring	External *3)	2450	-0,9 ... 16	1,8 ... 16	0,59	1 & 3	SXE9574-Z76-8#-*1)
	3	—	Solenoid/spring	External *3)	4400	-0,9 ... 16	1,8 ... 16	0,85	1 & 3	SXE9575-Z76-8#-*1)
	1	Built-in	Solenoid/spring	External *3)	1230	-0,9 ... 16	1,8 ... 16	0,33	1 & 3	SXE9573-Z86-8#-*1)
	2	Built-in	Solenoid/spring	External *3)	2450	-0,9 ... 16	1,8 ... 16	0,59	1 & 3	SXE9574-Z86-8#-*1)
	3	Built-in	Solenoid/spring	External *3)	4400	-0,9 ... 16	1,8 ... 16	0,85	1 & 3	SXE9575-Z86-8#-*1)
	1	—	Solenoid/solenoid	Internal	1230	2 ... 16	—	0,45	2 & 4	SXE0573-Z50-8#-*1)
	2	—	Solenoid/solenoid	Internal	2450	2 ... 16	—	0,72	2 & 4	SXE0574-Z50-8#-*1)
	3	—	Solenoid/solenoid	Internal	4400	2 ... 16	—	0,96	2 & 4	SXE0575-Z50-8#-*1)
	1	Built-in	Solenoid/solenoid	Internal	1230	2 ... 16	—	0,45	2 & 4	SXE0573-Z60-8#-*1)
	2	Built-in	Solenoid/solenoid	Internal	2450	2 ... 16	—	0,72	2 & 4	SXE0574-Z60-8#-*1)
	3	Built-in	Solenoid/solenoid	Internal	4400	2 ... 16	—	0,96	2 & 4	SXE0575-Z60-8#-*1)
	1	—	Solenoid/solenoid	External *3)	1230	-0,9 ... 16	2 ... 16	0,45	2 & 4	SXE0573-Z55-8#-*1)
	2	—	Solenoid/solenoid	External *3)	2450	-0,9 ... 16	2 ... 16	0,72	2 & 4	SXE0574-Z55-8#-*1)
	3	—	Solenoid/solenoid	External *3)	4400	-0,9 ... 16	2 ... 16	0,96	2 & 4	SXE0575-Z55-8#-*1)
	1	Built-in	Solenoid/solenoid	External *3)	1230	-0,9 ... 16	2 ... 16	0,45	2 & 4	SXE0573-Z65-8#-*1)
	2	Built-in	Solenoid/solenoid	External *3)	2450	-0,9 ... 16	2 ... 16	0,72	2 & 4	SXE0574-Z65-8#-*1)
	3	Built-in	Solenoid/solenoid	External *3)	4400	-0,9 ... 16	2 ... 16	0,96	2 & 4	SXE0575-Z65-8#-*1)
	1	—	Solenoid/solenoid *2)	Internal	1230	2 ... 16	—	0,45	2 & 4	SXE1573-Z50-8#-*1)
	2	—	Solenoid/solenoid *2)	Internal	2450	2 ... 16	—	0,72	2 & 4	SXE1574-Z50-8#-*1)
	3	—	Solenoid/solenoid *2)	Internal	4400	2 ... 16	—	0,96	2 & 4	SXE1575-Z50-8#-*1)
	1	—	Solenoid/solenoid *2)	External *3)	1230	-0,9 ... 16	2 ... 16	0,45	2 & 4	SXE1573-Z55-8#-*1)
	2	—	Solenoid/solenoid *2)	External *3)	2450	-0,9 ... 16	2 ... 16	0,72	2 & 4	SXE1574-Z55-8#-*1)
	3	—	Solenoid/solenoid *2)	External *3)	4400	-0,9 ... 16	2 ... 16	0,96	2 & 4	SXE1575-Z55-8#-*1)

# Insert code for manual override: 0 = push and turn, 1 = push only

\*1) Insert voltage code from tables below or without coil; SXE\*\*7\*-Z\*\*-\*8\*K

\*2) Pilot side 14 priority

\*3) External pilot supply for ISO1 at port 14 only; ISO2 and ISO3 at port 12 or 14 (unconnected port 12 or 14 has to be plugged).

Voltage codes and spare coils for 16 bar models

30 mm coil for connector interface acc. acc. EN 175 301-803, form A				
Voltage	Power Inrush/Hold	Model	Code	
12 V d.c.	4 W	V10633-A32N	32N	
24 V d.c.	4 W	V10633-A33N	33N	
110 V d.c.	4 W	V10633-A37N	37N	
24 V a.c.	10/8 VA	V10633-A84N	84N	
110/120 V 50/60 Hz	10/8 VA	V10633-A88N	88N	
220/240 V 50/60 Hz	10/8 VA	V10633-A89N	89N	

Other Voltages available on request.







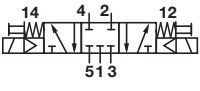

Connector plug - ordered separately

30 mm, EN 175301-803 (DIN 43650 B) Form A 2-pole + PE

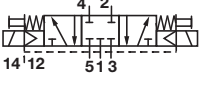

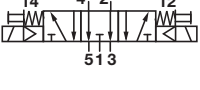
0570275

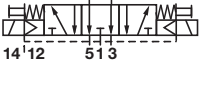
**5/3 Solenoid pilot actuated valves – 16 bar solenoid solenoid pilot pressure**

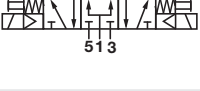
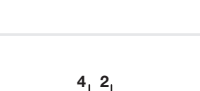
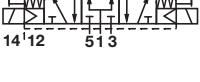
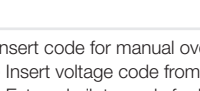
Symbol	ISO size	Flow regulator	Actuation	Function	Pilot supply	Flow (l/min)	Operating pressure (bar)	Pilot pressure (bar)	Weight (kg)	Drawing No.	Model CNOMO solenoid actuated valves
	1	–	Solenoid/solenoid	APB	Internal	1320	2 ... 16	—	0,45	2 & 4	SXE9673-Z50-8#-1)
	2	–	Solenoid/solenoid	APB	Internal	2520	2 ... 16	—	0,72	2 & 4	SXE9674-Z50-8#-1)
	3	–	Solenoid/solenoid	APB	Internal	4650	2 ... 16	—	0,96	2 & 4	SXE9675-Z50-8#-1)
	1	Built-in	Solenoid/solenoid	APB	Internal	1320	2 ... 16	—	0,45	2 & 4	SXE9673-Z60-8#-1)
	2	Built-in	Solenoid/solenoid	APB	Internal	2520	2 ... 16	—	0,72	2 & 4	SXE9674-Z60-8#-1)
	1	–	Solenoid/solenoid	APB	External *3)	1320	-0,9 ... 16	2 ... 16	0,45	2 & 4	SXE9673-Z55-8#-1)
	2	–	Solenoid/solenoid	APB	External *3)	2520	-0,9 ... 16	2 ... 16	0,72	2 & 4	SXE9674-Z55-8#-1)
	3	–	Solenoid/solenoid	APB	External *3)	4650	-0,9 ... 16	2 ... 16	0,96	2 & 4	SXE9675-Z55-8#-1)
	1	Built-in	Solenoid/solenoid	APB	External *3)	1320	-0,9 ... 16	2 ... 16	0,45	2 & 4	SXE9673-Z65-8#-1)
	2	Built-in	Solenoid/solenoid	APB	External *3)	2520	-0,9 ... 16	2 ... 16	0,72	2 & 4	SXE9674-Z65-8#-1)
	1	–	Solenoid/solenoid	COE	Internal	1320	2 ... 16	—	0,45	2 & 4	SXE9773-Z50-8#-1)
	2	–	Solenoid/solenoid	COE	Internal	2520	2 ... 16	—	0,72	2 & 4	SXE9774-Z50-8#-1)
	3	–	Solenoid/solenoid	COE	Internal	4650	2 ... 16	—	0,96	2 & 4	SXE9775-Z50-8#-1)
	1	Built-in	Solenoid/solenoid	COE	Internal	1320	2 ... 16	—	0,45	2 & 4	SXE9773-Z60-8#-1)
	2	Built-in	Solenoid/solenoid	COE	Internal	2520	2 ... 16	—	0,72	2 & 4	SXE9774-Z60-8#-1)
	1	–	Solenoid/solenoid	COE	External *3)	1320	-0,9 ... 16	2 ... 16	0,45	2 & 4	SXE9773-Z55-8#-1)
	2	–	Solenoid/solenoid	COE	External *3)	2520	-0,9 ... 16	2 ... 16	0,72	2 & 4	SXE9774-Z55-8#-1)
	3	–	Solenoid/solenoid	COE	External *3)	4650	-0,9 ... 16	2 ... 16	0,96	2 & 4	SXE9775-Z55-8#-1)
	1	Built-in	Solenoid/solenoid	COE	External *3)	1320	-0,9 ... 16	2 ... 16	0,45	2 & 4	SXE9773-Z65-8#-1)
	2	Built-in	Solenoid/solenoid	COE	External *3)	2520	-0,9 ... 16	2 ... 16	0,72	2 & 4	SXE9774-Z65-8#-1)
	1	–	Solenoid/solenoid	COP	Internal	1320	2 ... 16	—	0,45	2 & 4	SXE9873-Z50-8#-1)
	2	–	Solenoid/solenoid	COP	Internal	2520	2 ... 16	—	0,72	2 & 4	SXE9874-Z50-8#-1)
	3	–	Solenoid/solenoid	COP	Internal	4650	2 ... 16	—	0,96	2 & 4	SXE9875-Z50-8#-1)
	1	Built-in	Solenoid/solenoid	COP	Internal	1320	2 ... 16	—	0,45	2 & 4	SXE9873-Z60-8#-1)
	2	Built-in	Solenoid/solenoid	COP	Internal	2520	2 ... 16	—	0,72	2 & 4	SXE9874-Z60-8#-1)
	1	–	Solenoid/solenoid	COP	External *3)	1320	-0,9 ... 16	2 ... 16	0,45	2 & 4	SXE9873-Z55-8#-1)
	2	–	Solenoid/solenoid	COP	External *3)	2520	-0,9 ... 16	2 ... 16	0,72	2 & 4	SXE9874-Z55-8#-1)
	3	–	Solenoid/solenoid	COP	External *3)	4650	-0,9 ... 16	2 ... 16	0,96	2 & 4	SXE9875-Z55-8#-1)
	1	Built-in	Solenoid/solenoid	COP	External *3)	1320	-0,9 ... 16	2 ... 16	0,45	2 & 4	SXE9873-Z65-8#-1)
	2	Built-in	Solenoid/solenoid	COP	External *3)	2520	-0,9 ... 16	2 ... 16	0,72	2 & 4	SXE9874-Z65-8#-1)

# Insert code for manual override: 0 = push and turn, 1 = push only

\*1) Insert voltage code from tables below or without coil; SXE\*\*7\*-Z\*\*-8\*K

\*3) External pilot supply for ISO1 at port 14 only; ISO2 and ISO3 at port 12 or 14 (unconnected port 12 or 14 has to be plugged).

Valve function:  
 APB = All Ports Blocked  
 COE = Centre Open Exhaust  
 COP = Centre Open Pressure

**Option selector  
(solenoid actuated valves)**

SXE★★7★-★★★-★★-★★★

Valve function	Substitute	Voltage code for valve with coil	Substitute
5/2 solenoid/solenoid, bistable valve	05	For voltage code see tables on page 2 and 4	
5/2 solenoid/solenoid, bistable valve with side 14 priority	15	<b>Valve without coil</b>	Substitute
5/2 solenoid/spring, monostable valve	95	Remove dash (-)	K
5/3 - APB	96	<b>Manual override</b>	Substitute
5/3 - COE	97	Push and turn to lock (standard - End solenoid)	0
5/3 - COP	98	Push only	1
<b>ISO size</b>	Substitute	<b>Operating pressure</b>	Substitute
ISO 1	3	10 bar - end solenoid actuated valves	0
ISO 2	4	10 bar - CNOMO solenoid actuated valves	6
ISO 3	5	16 bar - CNOMO solenoid actuated valves	8
<b>Solenoid position</b>	Substitute	<b>Pilot supply</b>	Substitute
End solenoid actuated valves	A	Internal (double solenoid or single solenoid/air spring)	0
CNOMO solenoid actuated valves	Z	Internal (single solenoid valve, mechanical spring)	1
<b>Integrated flow control</b>	Substitute	External (double solenoid or single solenoid/air spring)	5
Without flow regulator (double solenoid)	5	External (single solenoid valve, mechanical spring)	6
With flow regulator (double solenoid)	6		
Without flow regulator (solenoid & spring)	7		
With flow regulator (solenoid & spring)	8		

Note; Valves without coil - order coil separately according to voltage tables applicable for the solenoid pilot pressure 10 or 16 bar





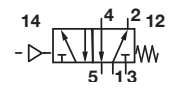
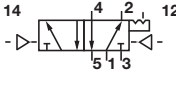
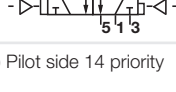

**5/2 air pilot actuated valves**

Symbol	ISO size	Flow regulator	Actuation	Flow (l/min)	Operating pressure (bar)	Pilot pressure (bar)	Weight (kg)	Drawing No.	Model
	1	–	Air/spring	1230	-0,9 ... 16	1,8 ... 16	0,21	5	SXP9573-170-00
	2	–	Air/spring	2450	-0,9 ... 16	1,8 ... 16	0,45	5	SXP9574-170-00
	3	–	Air/spring	4400	-0,9 ... 16	1,8 ... 16	0,72	5	SXP9575-170-00
	1	Built-in	Air/spring	1230	-0,9 ... 16	1,8 ... 16	0,21	5	SXP9573-180-00
	2	Built-in	Air/spring	2450	-0,9 ... 16	1,8 ... 16	0,45	5	SXP9574-180-00
	3	–	Air/air	4400	-0,9 ... 16	2 ... 16	0,72	6	SXP0575-170-00
	1	–	Air/air	1230	-0,9 ... 16	2 ... 16	0,30	6	SXP0573-170-00
	2	–	Air/air	2450	-0,9 ... 16	2 ... 16	0,50	6	SXP0574-170-00
	3	–	Air/air *2)	4400	-0,9 ... 16	2 ... 16	0,72	6	SXP1575-170-00

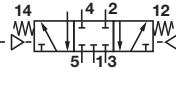
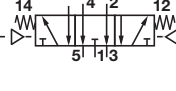
\*2) Pilot side 14 priority

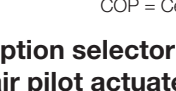
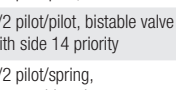
**5/3 air pilot actuated valves**

Symbol	ISO size	Flow regulator	Actuation	Function	Flow (l/min)	Operating pressure (bar)	Pilot pressure (bar)	Weight (kg)	Drawing No.	Model
	1	–	Air/air	APB	1230	-0,9 ... 16	1,8 ... 16	0,25	6	SXP9673-170-00
	2	–	Air/air	APB	2450	-0,9 ... 16	1,8 ... 16	0,58	6	SXP9674-170-00
	3	–	Air/air	APB	4400	-0,9 ... 16	1,8 ... 16	0,8	6	SXP9675-170-00
	1	Built-in	Air/air	APB	1230	-0,9 ... 16	1,8 ... 16	0,25	6	SXP9673-180-00
	2	Built-in	Air/air	APB	2450	-0,9 ... 16	1,8 ... 16	0,58	6	SXP9674-180-00
	3	–	Air/air	COE	4400	-0,9 ... 16	2 ... 16	0,80	6	SXP9775-170-00
	1	–	Air/air	COE	1230	-0,9 ... 16	2 ... 16	0,25	6	SXP9773-170-00
	2	–	Air/air	COE	2450	-0,9 ... 16	2 ... 16	0,58	6	SXP9774-170-00
	3	–	Air/air	COE	4400	-0,9 ... 16	2 ... 16	0,80	6	SXP9775-170-00
	1	Built-in	Air/air	COE	1230	-0,9 ... 16	2 ... 16	0,25	6	SXP9773-180-00
	2	Built-in	Air/air	COE	2450	-0,9 ... 16	2 ... 16	0,58	6	SXP9774-180-00
	3	–	Air/air	COP	4400	-0,9 ... 16	2 ... 16	0,80	6	SXP9875-170-00
	1	–	Air/air	COP	1230	-0,9 ... 16	2 ... 16	0,25	6	SXP9873-170-00
	2	–	Air/air	COP	2450	-0,9 ... 16	2 ... 16	0,58	6	SXP9874-170-00
	3	–	Air/air	COP	4400	-0,9 ... 16	2 ... 16	0,80	6	SXP9875-170-00
	1	Built-in	Air/air	COP	1230	-0,9 ... 16	2 ... 16	0,25	6	SXP9873-180-00
	2	Built-in	Air/air	COP	2450	-0,9 ... 16	2 ... 16	0,58	6	SXP9874-180-00

Valve function: APB = All Ports Blocked,  
COE = Centre Open Exhaust,  
COP = Centre Open Pressure

**Option selector  
(air pilot actuated valves)**
**SXP★★7★-1★0-00**

Valve function	Substitute	Integrated flow control	Substitute
5/2 pilot/pilot, bistable valve	<b>05</b>	Without	<b>7</b>
5/2 pilot/pilot, bistable valve with side 14 priority	<b>15</b>	With	<b>8</b>
5/2 pilot/spring, monostable valve	<b>95</b>		
5/3 - APB	<b>96</b>		
5/3 - COE	<b>97</b>		
5/3 - COP	<b>98</b>		
ISO size	Substitute		
ISO 1	<b>3</b>		
ISO 2	<b>4</b>		
ISO 3	<b>5</b>		

**Exhaust flow characteristics for valves with integral flow regulators**

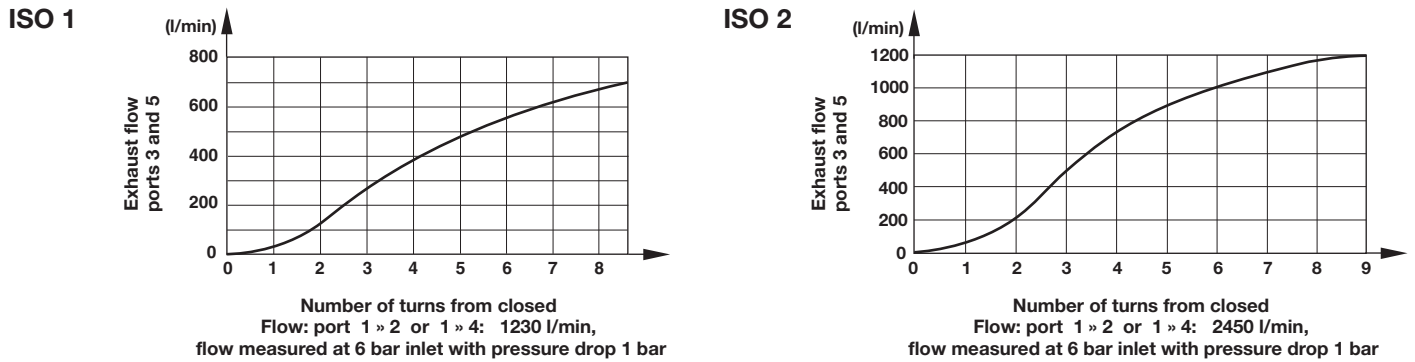

**Sub-bases, end plates and blanking disc - VDMA 24345 sub-base options**

ISO size	Single station sub-base, Form A side ported		Single station sub-base Form B bottom ported		Modular sub-base Form C		Form D End plates		Blanking disc for VDMA sub-bases *1)	
	Page 11	ISO G thread NPT thread	Page 11	ISO G thread	Page 11	ISO G thread NPT thread	Page 11	ISO G thread NPT thread	Page 12	ISO G thread NPT thread
1	M/P19126 (1/4)	C/P19126 (1/4)	M/P19125 (1/4)	CQM/22152/3/21	239-238B	CQM/22152/3/22	239-289B	FP 8382	239-251	
2	M/P19132 (3/8)	C/P19132 (3/8)	M/P19131 (3/8)	CQM/22253/3/21	239-242B	CQM/22253/3/22	239-291B	FP 8482	239-252	
3	M/P19138 (1/2)	C/P19138 (1/2)	M/P19137 (1/2)	CQM/22354/3/21	239-246B	CQM/22354/3/22	239-293B	FP 8582	239-253	

**Universal sub-base options for ISO G parallel threads only**

ISO size	Modular base with side, end and bottom ports open	Universal end plate, all ports blocked	Universal end plate, side ports open	Transition plate from ISO 1 » ISO 2	Blanking disk for ISO 1 and ISO 2
Page 13	Page 13	Page 13	Page 13	Page 13	Page 13
1	CQM/22152/3/27 (G1/4)	CQM/22152/28 (G1/4)	CQM/22152/3/31 (G1/4)	CQM/22152/3/29	M/P43173
2	CQM/22253/3/27 (G3/8)	CQM/22153/28 (G3/8)	CQM/22253/3/31 (G3/8)	CQM/22152/3/29	M/P43174

**Accessories for ISO G parallel and NPT threads**

ISO size	Blanking plate for VDMA and universal sub-bases	Transition plate for VDMA sub-bases	Silencer	Sandwich plate with check valves	Flow regulator plate, ports 3 and 5 regulated
Page 12	Page 12	Page 12	Page 12	Page 16	Page 16
1	CQM/22152/3/23	CQM/22152/3/24 (1 × 2)	0015510	FP7050	—
2	CQM/22253/3/23	CQM/22253/3/24 (2 × 3)	—	—	—
3	CQM/22354/3/23	FP8570 (1 × 3)	—	FP7070	CQM/22354/3/26

**Sandwich plates - ISO size 1**

ISO size	Single pressure regulator plate, port 1 regulated	Single pressure regulator plate, port 1 regulated	Single pressure regulator plate, port 2 regulated	Single pressure regulator plate, port 4 regulated	Double pressure regulator plate, port 2 & 4 regulated
Page 14	Page 14	Page 14	Page 14	Page 14	Page 15
1	V71010-KB1 (Regulator on side 14)	V71011-KB1 (Regulator on side 12)	V71012-KB2	V71012-KB3	V71012-KB4



**Drawings**

 Dimensions in mm  
 Projection/First angle

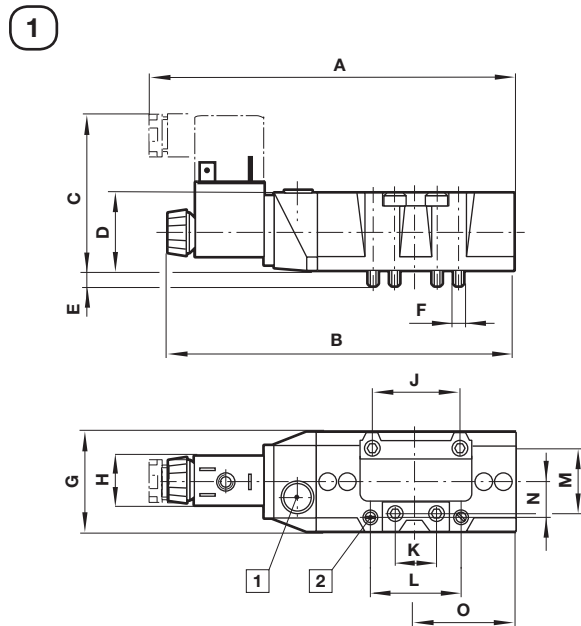
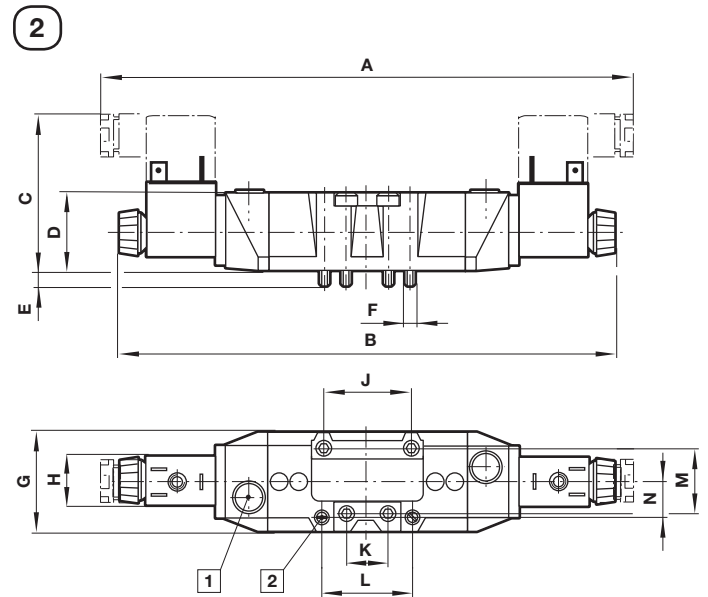
**SXE 957\*-A models**  
**Single end solenoid pilot valves**

**SXE 057\*-A and SXE9\*7\*-A models**  
**Double end solenoid pilot valves**

① Manual override  
 ② Flow regulators

ISO size	A	B	C	D	E	F	G	H	J
1	154	146	66	33	7,5	M5	42	22/30	36
2	181	173	71	42	8	M6	55	22/30	48
3	207,5	197	72	43	11,5	M8	62,5	22/30	64
ISO size	K	L	M	N	O	kg	Model		
1	18	38	28	15	42	0,33	SXE 9573-A...		
2	24	48	38	20	53	0,59	SXE 9574-A...		
3	32	-	48	-	65,5	0,85	SXE 9575-A...		

ISO size	A	B	C	D	E	F	G	H	J
1	222	204	65	33	7,5	M5	42	22/30	36
2	255	239	71	42	8	M6	55	22/30	48
3	284	263	72	43	11,5	M8	62,5	22/30	64
ISO size	K	L	M	N	kg	Model			
1	18	38	28	15	0,45	SXE 0573-A..., SXE 9.73-A...			
2	24	48	38	20	0,72	SXE 0574-A..., SXE 9.74-A...			
3	32	-	48	-	0,96	SXE 0575-A..., SXE 9.75-A...			

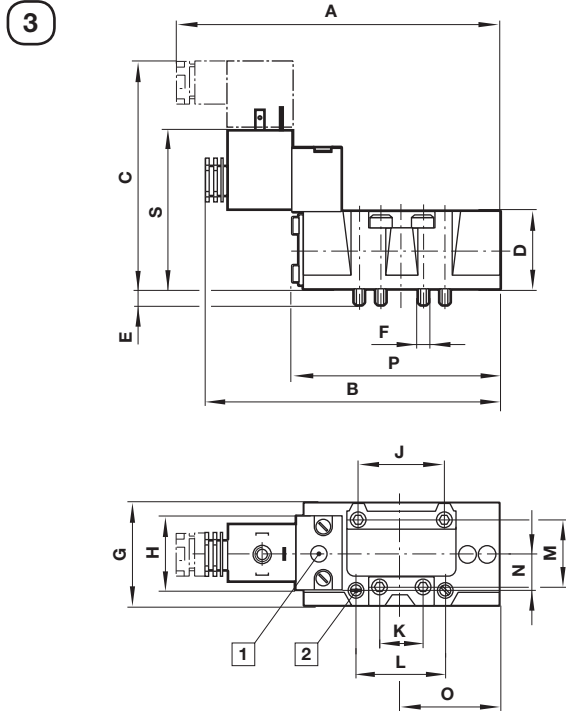
**SXE 957\*-Z models**  
**Single CNOMO solenoid pilot valves**



ISO size	A	B	C	D	E	F	G	H	J	K
1	137,5	128	98	33	7,5	M5	42	32	36	18
2	157,5	148	107	42	8	M6	55	32	48	24
3	181	170	108	43	11,5	M8	62,5	32	64	32
ISO size	L	M	N	O	P	S	kg	Model		
1	38	28	15	42	88	62	0,6	SXE 9573-Z...		
2	48	38	20	53	112	71	0,8	SXE 9574-Z...		
3	-	48	-	65,5	135,5	78,5	1,0	SXE 9575-Z...		

**SXE 057\*-Z and SXE9\*7\*-Z models**  
**Double CNOMO solenoid pilot valves**

Dimensions in mm  
Projection/First angle

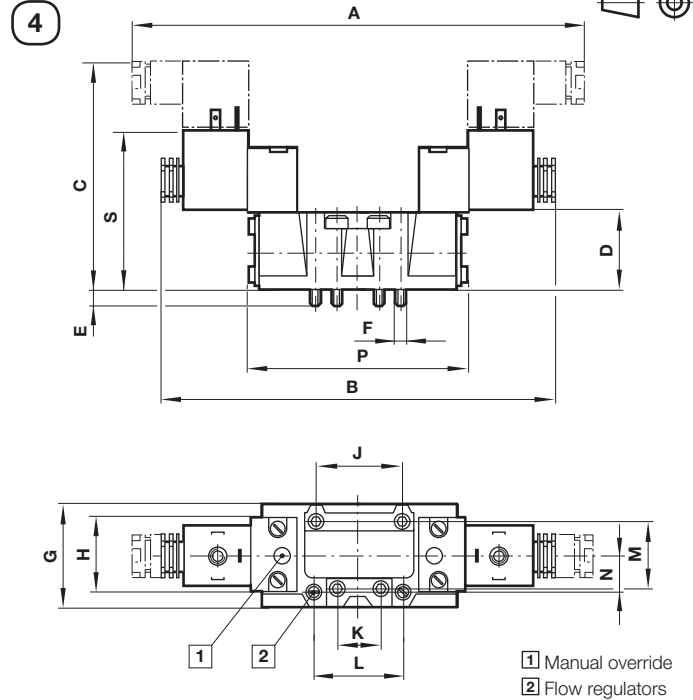

ISO size	A	B	C	D	E	F	G	H	J	K
1	191	171	89	33	7,5	M5	42	32	36	18
2	208	189	107	42	8	M6	55	32	48	24
3	231	212	108	43	11,5	M8	62,5	32	64	32
ISO size	L	M	N	P	S	kg	Model			
1	38	28	15	92,5	62	1,0	SXE0573-Z..., SXE 9.73-Z...			
2	48	38	20	119	71	1,2	SXE 0574-Z..., SXE 9.74-Z...			
3	-	48	-	140 (142)	78,5	1,4	SXE 0575-Z..., SXE 9.75-Z...			

( ) for 5/3 way valves

**SXP957\* models**  
**Single air pilot valve**

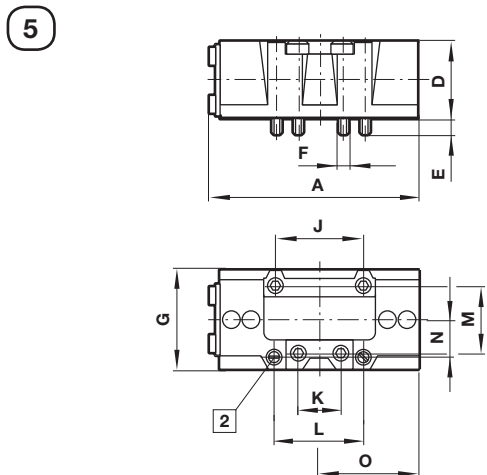

ISO size	A	D	E	F	G	J	K
1	88	33	7,5	M5	42	36	18
2	112	42	8	M6	55	48	24
3	135,5	43	11,5	M8	62,5	64	32
ISO size	L	M	N	O	kg	Model	
1	38	28	15	42	0,3	SXP9573-..., SXP*573-...	
2	48	38	20	53	0,5	SXP9574-..., SXP*574-...	
3	-	48	-	65,5	0,7	SXP9575-..., SXP*574-...	

**SXP\*57\*, SXP967\*, SXP977\* & SXP987\* models**  
**Double air pilot valve**

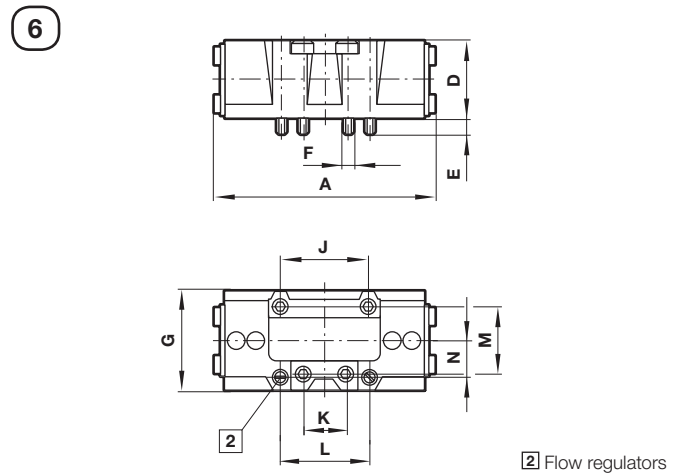

ISO size	A	D	E	F	G	J	K
1	92,5	33	7,5	M5	42	36	18
2	119	42	8	M6	55	48	24
3	140 (142)	43	11,5	M8	62,5	64	32
ISO size	L	M	N	kg	Model		
1	38	28	15	0,3	SXP0573-..., SXP9*73-...		
2	48	38	20	0,5	SXP*574-..., SXP9*74-...		
3	-	48	-	0,7	SXP*575-..., SXP9*75-...		

( ) for 5/3 way valves

Sub-bases and end plates

VDMA 24345 sub-base options  
Single station sub-base side ported (Form A)  
for ISO G and NPT threads

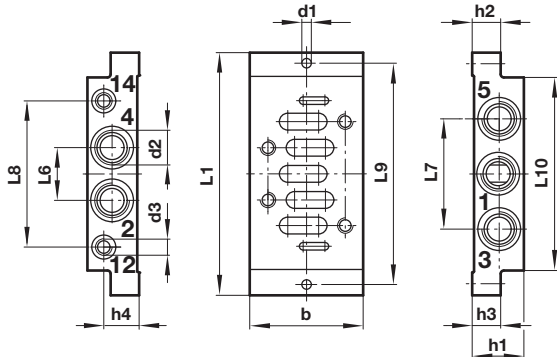

ISO size	b	d1	d2	d3	h1	h2	h3	Model
1	48	5,5	1/4"	1/8"	32	10	10,5 (21,5)	#/P19126
2	57	6,6	3/8"	1/8"	40	13	14 (26)	#/P19132
3	71	6,6	1/2"	1/8"	32	18	179	#/P19138

ISO size	h4	L1	L6	L7	L8	L9	L10	kg	Model
1	23,5	110	24	43	58	98	84	0,16	#/P19126
2	30	124	30	56	74	112	95	0,28	#/P19132
3	22	149	32	68	90	136	119	0,36	#/P19138

Single station sub-base  
bottom ported (Form B)  
for ISO G and NPT threads

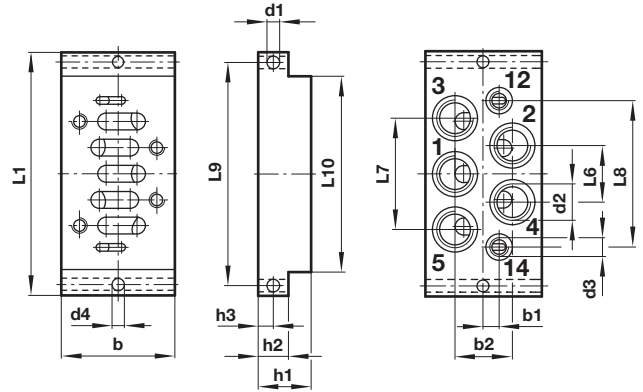

ISO size	b	b1	b2	d1	d2	d3	d4	h1	Model
1	46	7	23	5,5	1/4"	1/8"	5,5	30	#/P19125
2	56	8	27	6,6	3/8"	1/8"	6,6	35	#/P19131
3	71	10	34	6,6	1/2"	1/8"	6,69	32	#/P19137

ISO size	h2	h3	L1	L6	L7	L8	L9	L10	kg	Model
1	10	5	110	23	46	62	98	84	0,19	#/P19125
2	13	6,5	124	28	56	73	112	95	0,32	#/P19131
3	18	9	149	34	68	90	136	119	0,40	#/P19137

( ) Dimension for ports 3 and 5.  
# Insert 'M' for ISO G parallel or 'C' for NPT threads

Modular sub-bases (Form C) and end plates (Form D)  
for ISO G and NPT threads

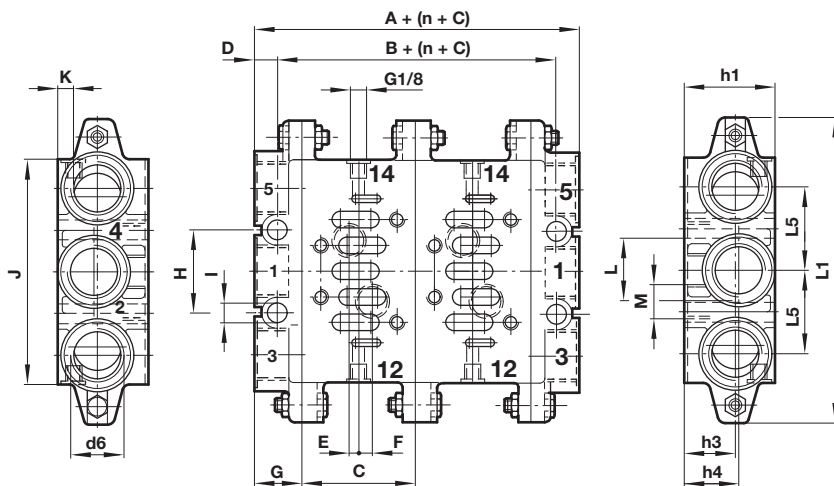

ISO size	A	B	C	D	E	F	G	H	I	kg	Model ISO G thread	Model NPT thread
1	44	22	43	11	1,5	7,5	22	28	7	0,24	CQM/22152/3/21	239-238B
2	52	26	56	13	5	6	26	35	9	0,36	CQM/22253/3/21	239-242B
3	60	30	71	15	6	8	30	52	12	0,72	CQM/22354/3/21	239-246B

ISO size	J	K	L	M	h1	h3	h4	L1	L5	d6	kg	Model ISO G thread	Model NPT thread
1	85	8,5	26	G1/4	46	21	24	110	28	3/8"	0,22	CQM/22152/3/22	239-289B
2	100	9	30	G3/8	47	22	24	135	28	1/2"	0,34	CQM/22253/3/22	239-291B
3	140	10	38	G1/2	56	31	34	190	52	1"	0,66	CQM/22354/3/22	239-293B

Dimensions in mm  
Projection/First angle



**Blanking plate for VDMA & universal sub-bases with ISO G and NPT threads**

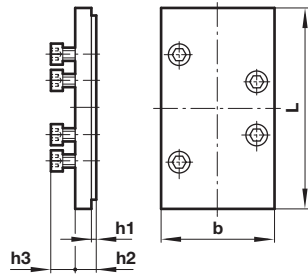

ISO size	b	L	h1	h2	h3	kg	Model
1	42	80	2	14	11	0,05	CQM/22152/3/23
2	55	85	2,5	12,5	13,5	0,09	CQM/22253/3/23
3	70	120	2,5	12,5	15,5	0,26	CQM/22354/3/23

**Silencer for VDMA & universal sub-bases with ISO G and NPT threads**

Dimensions in mm  
Projection/First angle

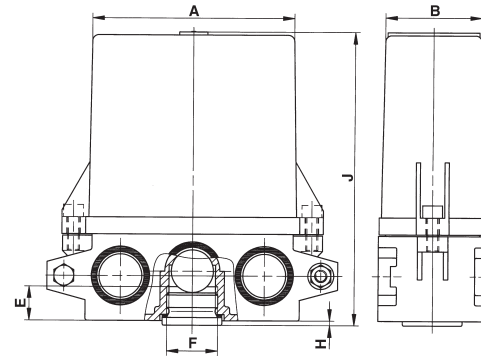

ISO size	A	B	E	F	H	J	Model
1	77	38	15	G3/8	2	122	0015510

**Transition plate from ISO 1 » ISO 2, ISO 2 » ISO 3 and ISO1 » ISO 3 for VDMA sub-bases for ISO G and NPT threads**

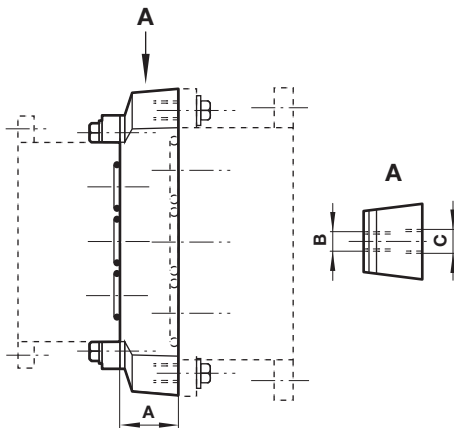

ISO size	A	B	C	kg	Model
1 » 2	25	M5	M6	0,35	CQM/22152/3/24
2 » 3	40	M6	M8	0,65	CQM/22253/3/24
1 » 3	34	M5	M8	0,90	FP8570

**Blanking disc  
FP8382, FP8482 & FP8582 for ISO G thread  
239-251, 239-252 & 239-253 for NPT thread**

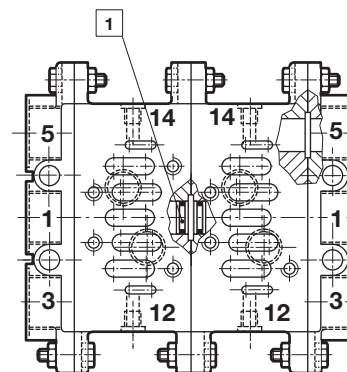

1 Blanking disc; FP8\*82 or 239-25\*

Universal sub-base options for ISO G threads only  
Modular base with side, end and bottom ports open

Transition plate from ISO 1 » ISO 2

Dimensions in mm  
Projection/First angle

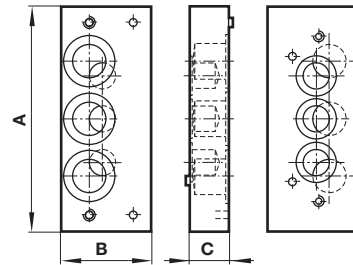
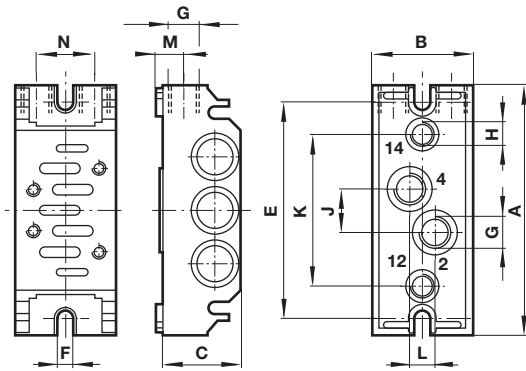

ISO size	A	B	C	E	F	G	H	J	K	L	M	N	kg	Model
1	106	43	36	92	5,5	G1/4	G1/8	18	64	11	12	28	0,16	CQM/22152/3/27
2	120	56	43	102	6,5	G3/8	G1/8	24	68	19	15	38	0,35	CQM/22253/3/27

ISO size	A	B	C	kg	Model
1 » 2	114	46	20	0,23	CQM/22152/3/29

Universal end plate, all ports blocked

Universal end plate, side ports open

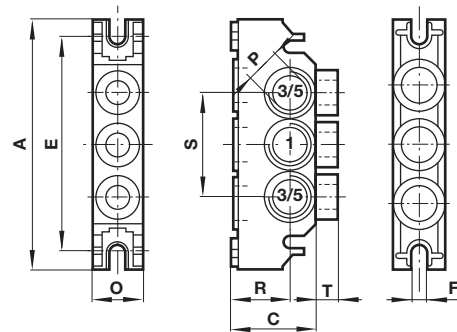
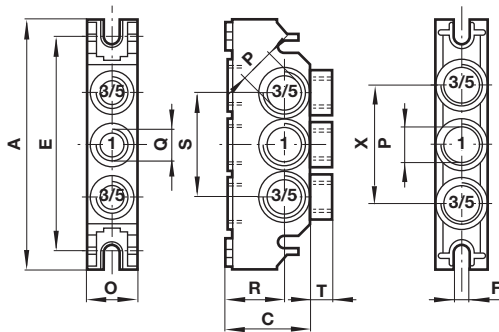

ISO size	A	C	E	F	O	P	Q	R	S	T	X	kg	Model
1	106	36	92	5,5	22	G3/8	G1/4	25	44	9	50	0,13	CQM/22152/3/28
2	120	46	102	6,5	29	G1/2	G1/4	31	58	7	58	0,23	CQM/22253/3/28

ISO size	A	C	E	F	O	P	R	S	T	kg	Model
1	106	36	92	5,5	22	G3/8	25	44	9	0,13	CQM/22152/3/31
2	120	46	102	6,5	29	G1/2	31	58	7	0,23	CQM/22253/3/31

Drill dimensions for opening ports

G1/4	Ø 8
G3/8	Ø 15
G1/2	Ø 15

Drill dimensions for opening ports

G1/4	Ø 8
G3/8	Ø 15
G1/2	Ø 15

Blanking disc for ISO 1 and ISO 2 universal sub-bases

ISO size	kg	Model
1	0,01	M/P43173
2	0,03	M/P43174

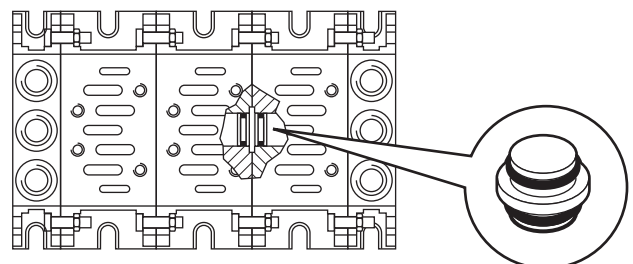

**Sandwich single pressure regulator plate with pressure regulator on port 1**

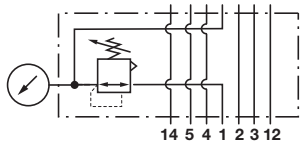
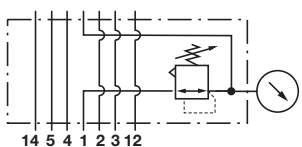
Symbol	ISO size	Regulator on side	Operation	Inlet pressure max. (bar)	Pressure range (bar)	Weight (kg)	Model
	1	14	Membrane pressure regulator with relieving valve	16	0,5 ... 12	0,6	V71010-KB1
	1	12	Membrane pressure regulator with relieving valve	16	0,5 ... 12	0,6	V71011-KB1

**Application:**

Pressure of port 1 can be regulated individually by using this intermediate plate.

**Note:**

Adjustment knob has push to lock feature.

**Sandwich single pressure regulator plate with pressure regulator on port 2 or port 4**

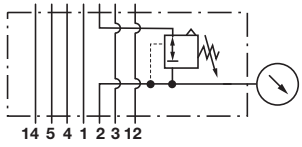
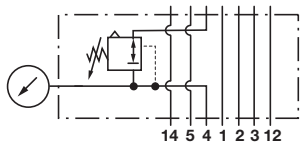
Symbol	ISO size	Regulated port	Operation	Inlet pressure max. (bar)	Pressure range (bar)	Weight (kg)	Model
	1	2	Membrane pressure regulator with relieving valve	16	0,5 ... 12	0,39	V71012-KB2
	1	4	Membrane pressure regulator with relieving valve	16	0,5 ... 12	0,39	V71012-KB3

**Application:**

Pressure of port 2 and 4 can be regulated individually by using this intermediate plate.

**Note:**

Adjustment knob has push to lock feature.

**Flow characteristics (inlet pressure: 8 bar)**

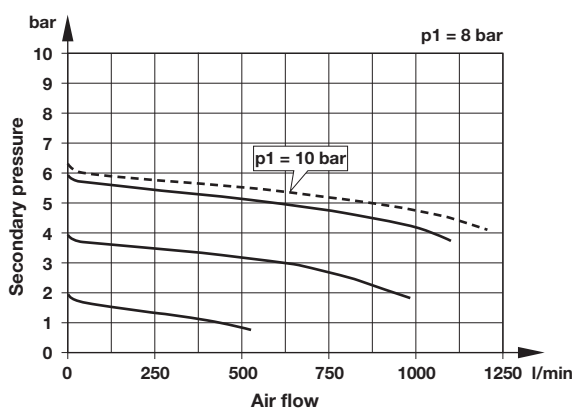

**Dimensions:**

Dimensions in mm  
Projection/First angle

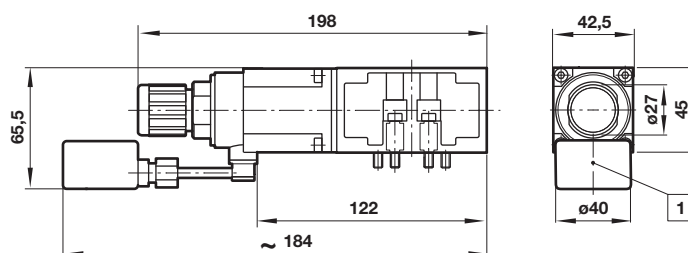

1 Gauge

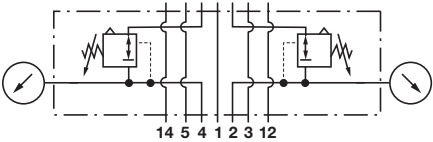

**Sandwich double pressure regulator plate with double pressure regulator on port 2 and 4**

Symbol	ISO size	Regulated port	Operation	Inlet pressure max. (bar)	Pressure range (bar)	Weight (kg)	Model
	1	2 and 4	Membrane pressure regulator with relieving valve	16	0,5 ... 12	0,39	V71012-KB4

**Application:**

Pressure of ports 2 and 4 can be regulated individually by using one of the intermediate plates.

**Note:**

Adjustment knob has push to lock feature.

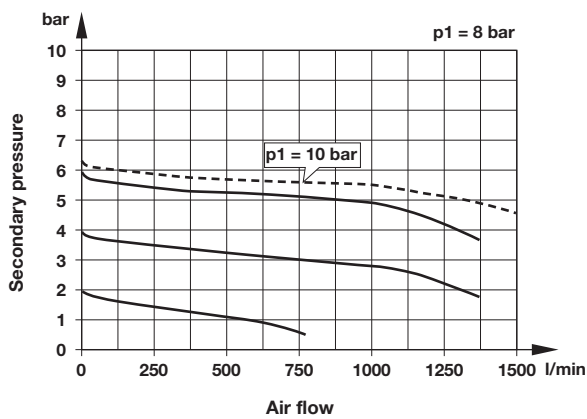
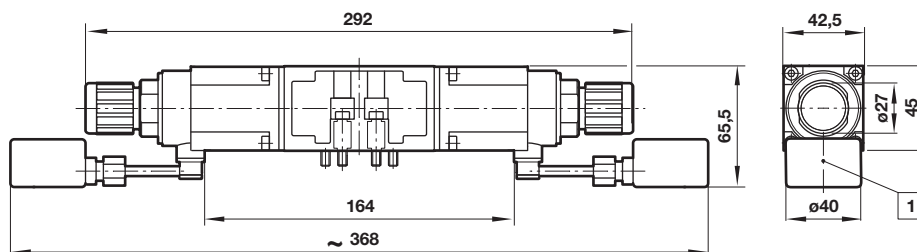
**Flow characteristics (inlet pressure: 8 bar)**

**Dimensions:**

Dimensions in mm  
Projection/First angle

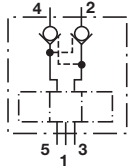

1 Gauge

### Sandwich plate with check valves

Symbol	ISO size	Design	Flow (l/min)	Operating pressure (bar)	Weight (kg)	Model
	1	Poppet valves	500	3 ... 8	0,45	FP7050
	3	Poppet valves	3400	3 ... 8	2,05	FP7070

**Application:**

With this type of intermediate plate together with a 5/3-way valve, center position open, a piston movement can be stopped in any desired position. This position will kept during a long period.

**Note:**

Metal to metal sealed spool and sleeve valves have always a small amount of leak because of its design. Therefore 5/3-way valves, center position closed, are only applicable for short stops.

**Caution: Not suitable for safety applications!**

### Dimensions

Dimensions in mm  
Projection/First angle

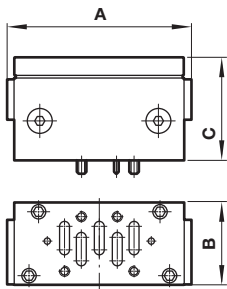

ISO	A	B	C	Model
1	96	42	52	FP7050
3	165	62	95	FP7070

### Flow regulator plate

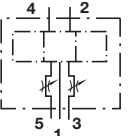
Symbol	ISO size	Regulated port	Operation	Inlet pressure max. (bar)	Weight (kg)	Model
	3	3 and 5	Piston regulator	-0,9 ... 16	0,86	CQM/22354/3/26

**Application:**

Regulation of exhaust ports 3 and 5 allows easy cylinder speed control

**Note:**

The regulator screw can be locked with the lock nut.

### Flow characteristics (inlet pressure: 8 bar)

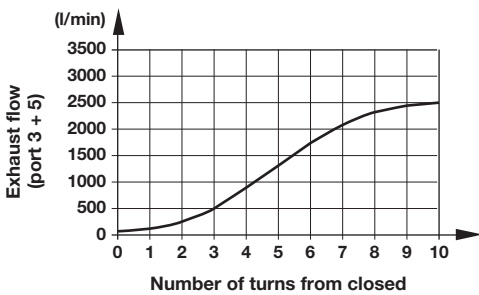

### Dimensions

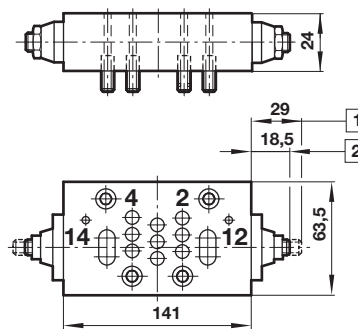

1 Fully open  
2 Fully closed

### Warning

These products are intended for use in industrial compressed air systems only. Do not use these products where pressures and temperatures can exceed those listed under »Technical features/data«.

Before using these products with fluids other than those specified, for non-industrial applications, life-support systems or other applications not within published specifications, consult IMI NORGREN.

Through misuse, age, or malfunction, components used in fluid power systems can fail in various modes.

The system designer is warned to consider the failure modes of all component parts used in fluid power systems and to provide adequate safeguards to prevent personal injury or damage to equipment in the event of such failure.

System designers must provide a warning to end users in the system instructional manual if protection against a failure mode cannot be adequately provided.

System designers and end users are cautioned to review specific warnings found in instruction sheets packed and shipped with these products.