

PRODUKTDATENBLATT

POLO-KAL NG Abzweig 125/110/87

Artikel-Nr. 02238

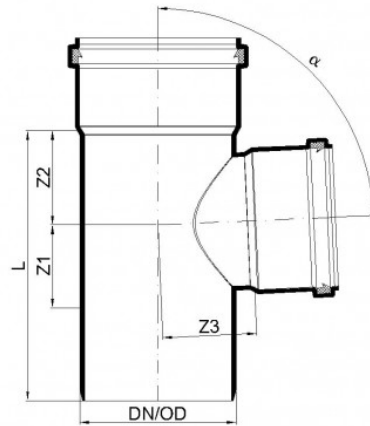

PURE
PROGRESS / poloplast

Technische Daten

DN/OD	125
DN/OD2	110
Winkel α	87,5°
Länge L	216 mm
Z1	67 mm
Z2	76 mm
Z3	75 mm
Gewicht	0,71 kg/Stk.
Verpackungseinheit	10 Stk.