

# Spezifikation für Freigabe / specification for release

Kunde / customer :  
 Artikelnummer / part number : **7490140122B**  
 Bezeichnung : **LAN-Übertrager WE-LAN High Voltage**  
 description : **LAN-Transformer WE-LAN High Voltage**



DATUM / DATE : 2018-03-28

**A Mechanische Abmessungen / dimensions :**

10/100 BaseT

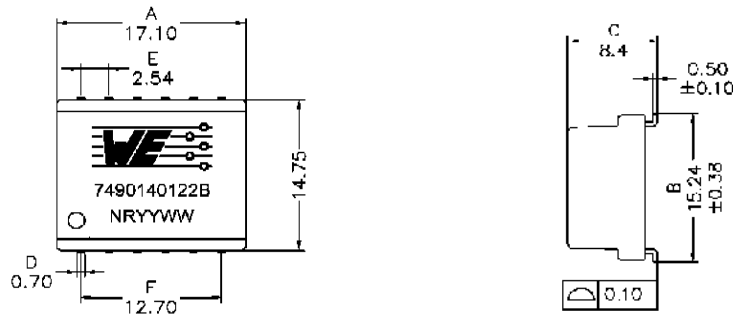

**B Elektrische Eigenschaften / electrical properties :**

**C Lötpad / soldering spec. :**

Eigenschaften / properties	Testbedingungen / test conditions		Wert / value	Einheit / unit	tol.
Induktivität / Inductance	100kHz / 100mV @ 8mA DC-Bias	OCL	350	µH	min.
Übersetzungsverhältnis / Turns ratio	100kHz / 100mV	TR	1 : 1	Tx	±2%
			1 : 1	Rx	
Insertion Loss	1-100MHz	IL	-2,0	dB	max.
Return Loss	1-30MHz	RL	-10	dB	min.
	30-60MHz		-7		
	60-80MHz		-5		
	80-100MHz		-4		
Common Mode Rejection Ratio	1-30MHz	CMRR	-35	dB	min.
	30-60MHz		-30		
	60-100MHz		-28		
Crosstalk	1-60MHz	CT	-42	dB	min.
	60-100MHz		-40		

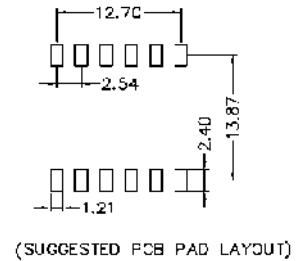

**D Prüfgeräte / test equipment :**

Agilent E5071C

**E Testbedingungen / test conditions :**

Luftfeuchtigkeit / Humidity: 33%  
 Umgebungstemperatur / Temperature: +25°C

**F Werkstoffe & Zulassungen / material & approvals :**

Basismaterial / Base material: Ferrit / Ferrite  
 Draht / Wire: 0UEW/Y 180  
 Kontaktmaterial / Contact plating: Cu-Ni-Sn  
 Gehäuse / Case: DAP Black per UL 94V-0

**G Eigenschaften / general specifications :**

Betriebstemp. / Operating temperature: -40°C - +85°C  
 Hochspannungsprüfung / Hipot test: 4500Vrms 1min.  
 UL60950-1 freigegeben: UL File Nummer E331896  
 UL60950-1 certified: UL File Nummer E331896  
 8.6mm min. Kriechstrecke und 7.0mm min. Luftstrecke  
 8.6mm min. creepage distance and 7.0mm min. clearance distance

Freigabe erteilt / general release:	Kunde / customer		
.....	Unterschrift / signature		
Datum / date	Würth Elektronik		
.....	Kontrolliert / approved		
Geprüft / checked	Name	Änderung / modification	Datum / date
	JaB	Version 02	2018-03-28
	JaB	Version 01	2017-01-10

**Würth Elektronik eiSos GmbH & Co.KG**

D-74638 Waldenburg · Max-Eyth-Straße 1 - 3 · Germany · Telefon (+49) (0) 7942 - 945 - 0 · Telefax (+49) (0) 7942 - 945 - 400  
<http://www.we-online.com>

## Spezifikation für Freigabe / specification for release

Kunde / customer :  
 Artikelnummer / part number : **7490140122B**  
 Bezeichnung : **LAN-Übertrager WE-LAN High Voltage**  
 description : **LAN-Transformer WE-LAN High Voltage**



DATUM / DATE : 2018-03-28

**H Schaltbild / Schematics :**

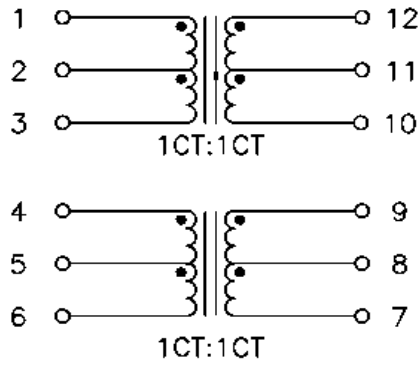

Datum / date	Unterschrift / signature													
	<b>Würth Elektronik</b>													
Geprüft / checked	Kontrolliert / approved													
		<table border="1" style="width: 100%; border-collapse: collapse;"> <tr> <td style="width: 33%;"></td> <td style="width: 33%;"></td> <td style="width: 33%;"></td> </tr> <tr> <td>JaB</td> <td>Version 02</td> <td>2018-03-28</td> </tr> <tr> <td>JaB</td> <td>Version 01</td> <td>2017-01-10</td> </tr> <tr> <td>Name</td> <td>Änderung / modification</td> <td>Datum / date</td> </tr> </table>				JaB	Version 02	2018-03-28	JaB	Version 01	2017-01-10	Name	Änderung / modification	Datum / date
JaB	Version 02	2018-03-28												
JaB	Version 01	2017-01-10												
Name	Änderung / modification	Datum / date												

**Würth Elektronik eiSos GmbH & Co.KG**

D-74638 Waldenburg · Max-Eyth-Straße 1 - 3 · Germany · Telefon (+49) (0) 7942 - 945 - 0 · Telefax (+49) (0) 7942 - 945 - 400  
<http://www.we-online.com>

# Spezifikation für Freigabe / specification for release

Kunde / customer :  
 Artikelnummer / part number : **7490140122B**  
 Bezeichnung : **LAN-Übertrager WE-LAN High Voltage**  
 description : **LAN-Transformer WE-LAN High Voltage**



DATUM / DATE : 2018-03-28

## I Rollenspezifikation / tape and reel specification :

### PACKAGING(Tape & Reel)

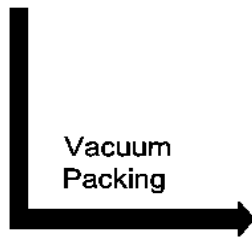
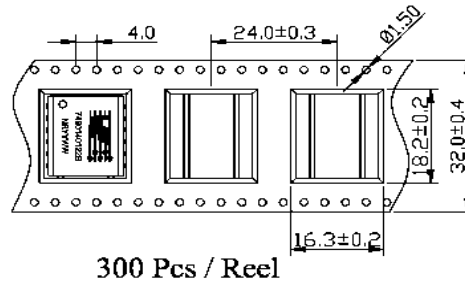
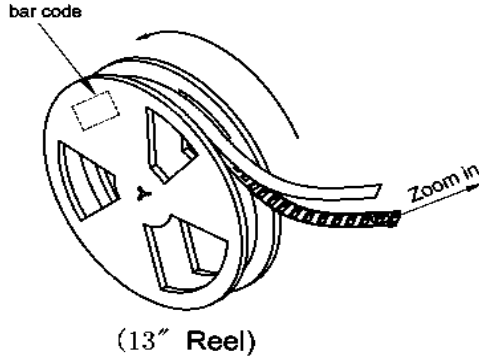

### Outside Carton

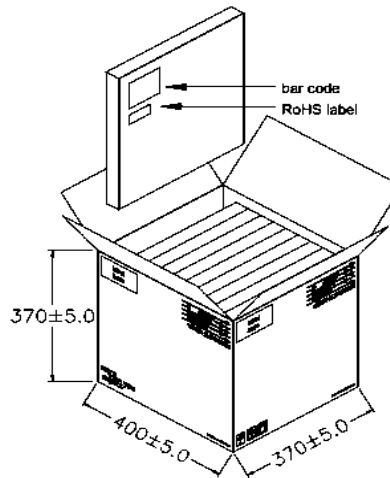

PACKING QUANTITY:

300pcs Finished Goods / Reel

8 Reels (2400pcs Finished Goods) / Carton

Freigabe erteilt / general release:	<b>Kunde / customer</b>			
.....	.....			
Datum / date	Unterschrift / signature			
.....	<b>Würth Elektronik</b>			
.....	.....			
Geprüft / checked	Kontrolliert / approved	Name	Änderung / modification	Datum / date
		JaB	Version 02	2018-03-28
		JaB	Version 01	2017-01-10

This electronic component has been designed and developed for usage in general electronic equipment. Before incorporating this component into any equipment where higher safety and reliability is especially required or if there is the possibility of direct damage or injury to human body, for example in the range of aerospace, aviation, nuclear control, submarine, transportation, (automotive control, train control, ship control), transportation signal, disaster prevention, medical, public information network etc. Würth Elektronik eiSos GmbH must be informed before the design-in stage. In addition, sufficient reliability evaluation checks for safety must be performed on every electronic component which is used in electrical circuits that require high safety and reliability functions or performance.

### Würth Elektronik eiSos GmbH & Co.KG

D-74638 Waldenburg · Max-Eyth-Straße 1 - 3 · Germany · Telefon (+49) (0) 7942 - 945 - 0 · Telefax (+49) (0) 7942 - 945 - 400  
<http://www.we-online.com>