



CM 06 EA 20-27 S

Industrial Connectors:Circular connector CM-series:Cable socket

Product description

Description	Straight cable socket, strain relief by means of a clamping cage
Type	CM 06 EA 20-27 S
Order No.	933 067-100
Number of contacts	14
Cable gland	PG 16
Cable diameter	12 mm to 14 mm
Conductor size	max. 1.5 mm ²
Standard	MIL-C 5015 bzw. VG 95 342
Housing Color	black

Drawing

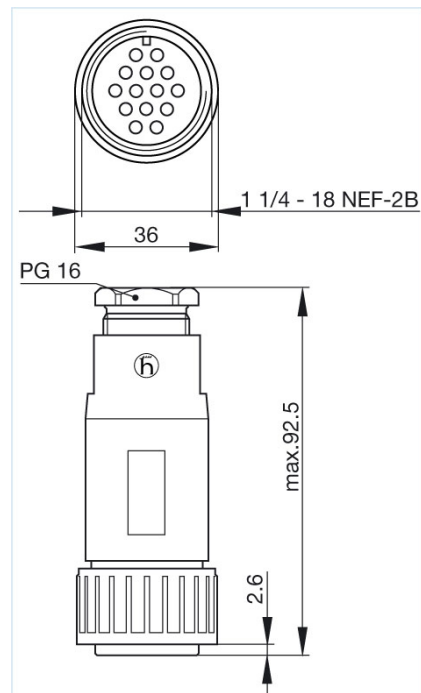

Technical data

Pin dimensions	1.6 mm
Rated voltage	AC/DC 50 V
Rated current	5 A
Contact resistance	≤ 5 mOhm
Type of termination	solder
Shell size	20

Material

Contact surface material	Ag
Contact bearer material	PA 66-GF 25
Housing material	PA 66-GF 25
O-Ring	NBR
Environmental conditions	
Protection class (IEC 60529)	IP 67
Pollution severity	3
Temperature range	-40 °C to +90 °C
Inflammability class	
Flammability, UL standard	94 V-1
Packing unit	
Packaging unit	100 pieces
Scope of delivery and accessories	
Scope of delivery	1 cable socket, not assembled, assembly instructions
Accessories to order separately	can be plugged into CM 02 E 20-27 P; cap CM 06 SD 20, order no. 831 767-100