

E11435

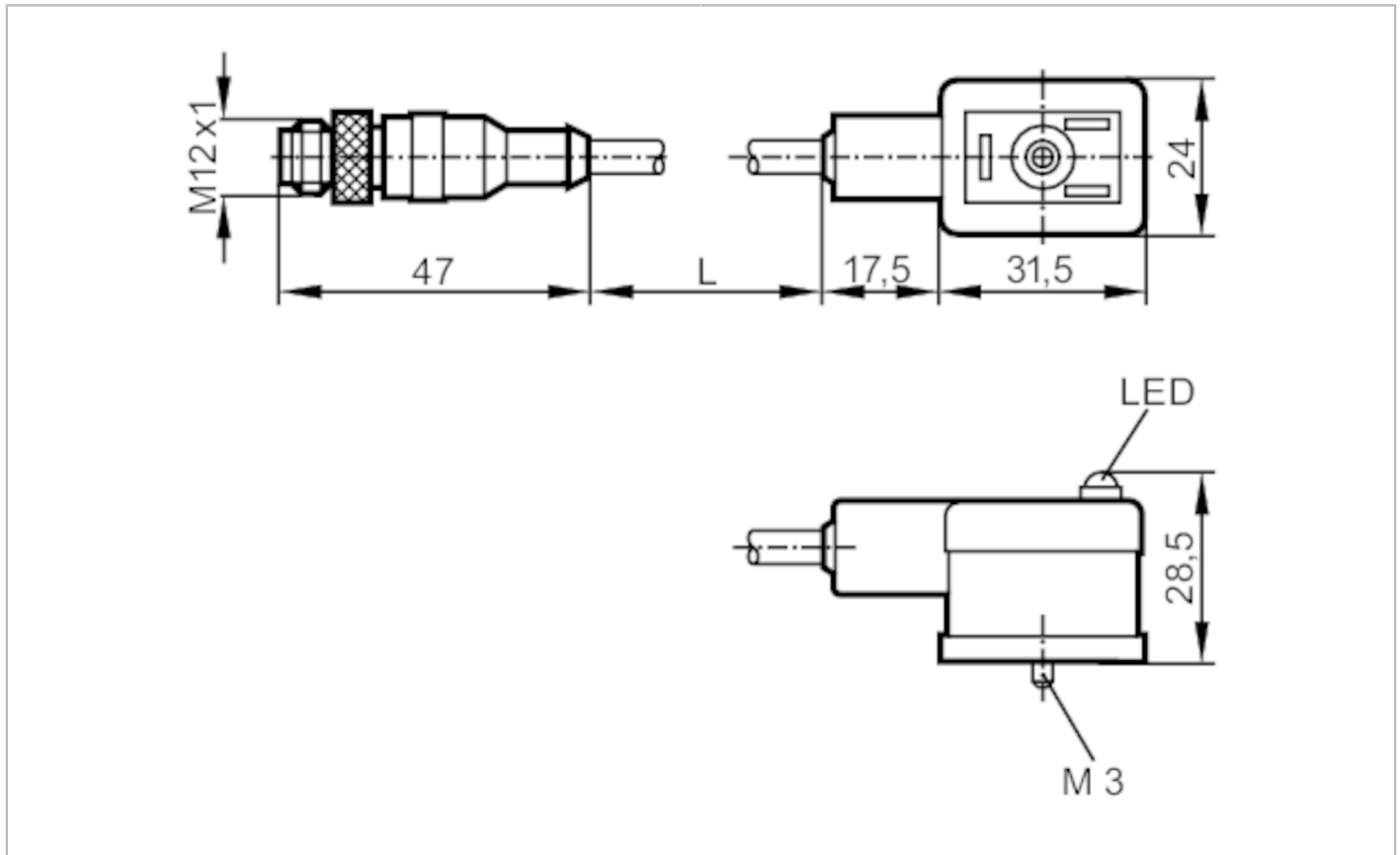

Jumper cable with valve plug

VVSAB031MSS0005H03STGH030MSS



Application		
Special feature	Free from silicone; Halogen-free; Gold-plated contacts	
Free from silicone	yes	
Electrical data		
Operating voltage [V]	< 24 AC/DC	
Overvoltage protection	yes; (VDR)	
Max. current load total [A]	3	
Operating conditions		
Ambient temperature [°C]	-25...80	
Protection	IP 67	
Mechanical data		
Weight [g]	267.3	
Materials	PUR	
Material nut	brass, nickel-plated / brass, nickel-plated	
Displays / operating elements		
Display	switching status	1 x LED, yellow
Accessories		
Accessories (supplied)	screw panel for labelling	
Remarks		
Pack quantity	1 pcs.	

E11435



Jumper cable with valve plug

VVSAB031MSS0005H03STGH030MSS

Electrical connection - plug

Connector: 1 x M12, straight; Moulded body: PUR; Locking: brass, nickel-plated; Contacts: gold-plated; Tightening torque: 0.7...0.9 Nm



Electrical connection

Cable: 5 m, PUR, Halogen-free, black, \varnothing 5 mm; 3 x 0.5 mm² (42 x \varnothing 0.1 mm)

Connection

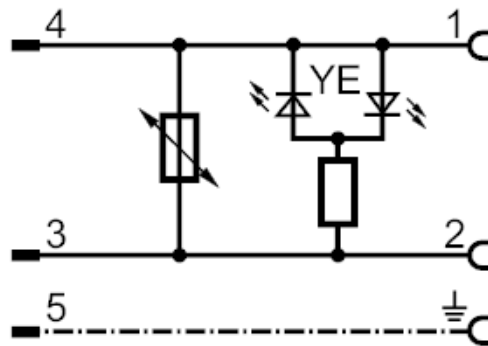

Electrical connection - socket

Connector: 1 x valve type B industrial standard, angled; Moulded body: PUR; Locking: brass, nickel-plated; Contacts: nickel-plated brass; Tightening torque: 0.7...0.9 Nm

