

The ECX-1637Q is a miniature SMD Crystal with a 2.0 x 1.6 mm footprint. AEC-Q200 Qualified

Request a Sample



OPERATING CONDITIONS / ELECTRICAL CHARACTERISTICS

PARAMETERS	CONDITIONS	ECX-1637Q			UNITS
		MIN	TYP	MAX	
Frequency		16.000		52.000	MHz
Mode of Oscillation	Fundamental				
Frequency Tolerance*	@ +25°C			± 30	ppm
Frequency Stability*	-40 ~ +125°C (ES Option)			± 50	ppm
Shunt Capacitance	Co			5	pF
Load Capacitance	Specify in P/N		8		pF
Drive Level	DL		10	100	μW
Operating Temperature*	Topr (ES Option)	-40		+125	°C
Storage Temperature	Tstg	-40		+125	°C
Aging (First Year)	@ +25°C ±3°C			±5	ppm

- Low Profile
- 2.0 x 1.6 mm Footprint
- RoHS Compliant
- AEC-Q200 Qualified

DIMENSIONS (mm)

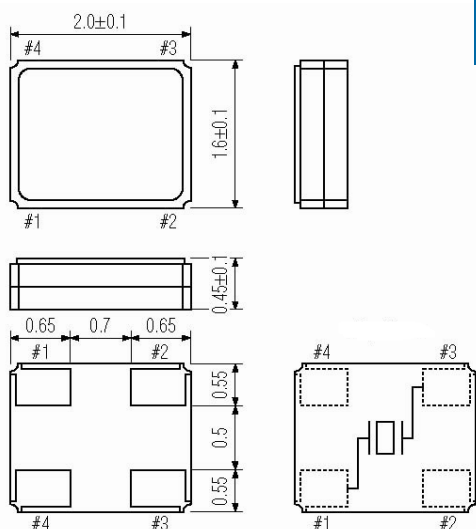

Figure 1) Top, Side, and Bottom

Crystal is symmetrical, pad 1 & 3 are interchangeable. Chamfer on the bottom pad has no electrical significance.

Pad Connections	
1	In/Out
2	Gnd
3	Out/In
4	Gnd

Frequency (MHz)	ESR Ω Max.
16.000 ~ 19.999	150
20.000 ~ 25.999	100
26.000 ~ 39.999	80
40.000 ~ 52.000	70

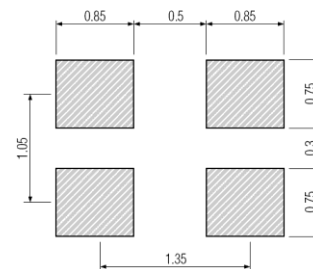

Figure 2) Suggested land pattern

PART NUMBERING GUIDE: Example ECS-240-8-37Q-ES-TR

ECS - FREQUENCY ABBREVIATION	LOAD CAPACITANCE	PACKAGE	AVAILABLE OPTIONS	PACKAGING
			Tolerance Stability Temp Range	

ECS	240 = 24.000 MHz See P/N Guide	8 = 8 pF S=Series	37Q = ECX-1637Q	Blank = Std A = ± 25 ppm J = ± 20 ppm R = ± 15 ppm C = ± 10 ppm	Blank = Std D = ± 100 ppm E = ± 50 ppm G = ± 30 ppm H = ± 25 ppm T = ± 20 ppm † W = ± 15 ppm † K = ± 10 ppm †	Blank = Std L = -10 ~ +70°C M = -20 ~ +70°C Y = -30 ~ +85°C N = -40 ~ +85°C P = -40 ~ +105°C S = -40 ~ +125°C U = -55 ~ +125°C	TR = Tape & Reel
-----	-----------------------------------	----------------------	--------------------	---	--	---	---------------------

* Specify available options in P/N.

† Contact ECS for availability over extended temp range.

POCKET TAPE DIMENSIONS (mm)

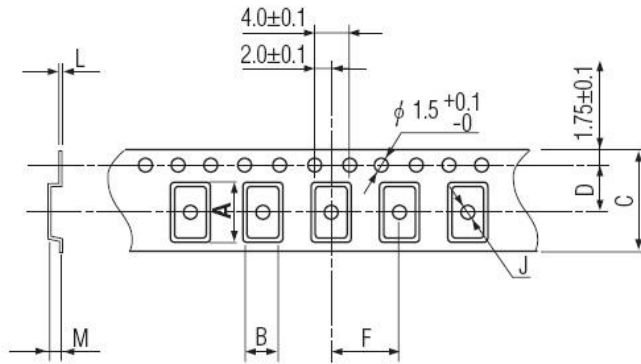

A	B	C	D	F	J	L	M	Reel Dia.	Qty/Reel
2.25	1.85	8.0	3.5	4.0	1.0	0.25	0.65	180	3000

SOLDER PROFILE
Peak solder Temp +260°C Max 10 sec Max.
2 Cycles Max.
MSL 1, Lead Finish Au

DEVELOPED FREQUENCIES	
Abbreviation	Frequency (MHZ)
192	19.200
200	20.000
240	24.000
245.7	24.5760
250	25.000
260	26.000
270	27.000
271.2	27.120
300	30.000
320	32.000
400	40.000
480	48.000

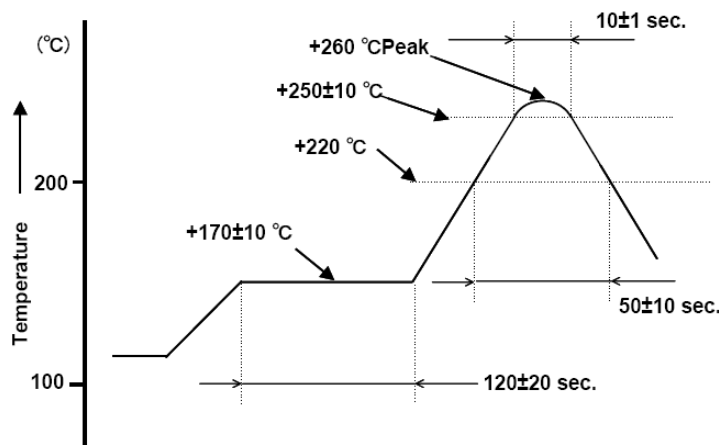

Figure 1) Suggested Reflow Profile