

# Data Sheet | Item Number: 765-1104/100-000

8-channel digital input/output; Profinet; DC 24 V / 2.0 A; 4xM12 connection; SlimLine

<https://www.wago.com/765-1104/100-000>

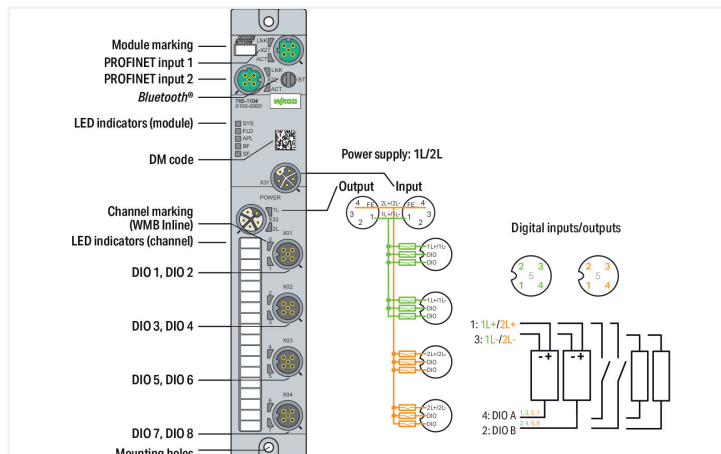

## Technical data

### Fieldbus

Communication	PROFINET PROFINET IO device; 2-port switch, LLDP, MRP, SNMP
Connection technology: communication/fieldbus	2 x D-coded M12; 4-pole
Interface standard	10BASE-T/100BASE-TX; potential-free
Autonegotiation; autocrossover	Yes
PROFINET IO features	PROFINET IO device; 2-port switch, LLDP, MRP, SNMP

### Device functions

Parameter	Input filter Output current Temperature
Diagnostics	Undervoltage; overcurrent; overload; overtemperature
Device functions	Bluetooth® OPC UA server
Visualization	Android/iOS app Web server

### Digital inputs/outputs

Number of digital inputs	8
Number of digital outputs	8
Connection technology: inputs/outputs	4 x A-coded M12; 5-pole
Signal type (voltage)	24 VDC
Input characteristic	high-side switching Type 3, per IEC 61131-2
Input filter	0.2 ... 20 ms
Output current (per channel)	2 A (typ.) for DO
Supply current per port	1L/2L: 4 A (max.)

### Supply (module)

Connection technology: supply	2 x L-coded M12; 5-pole
Supply voltage	24 VDC (18 ... 31.2 V); 1L/2L
Current consumption (max.)	16000 mA
Current consumption (note)	per supply line; overload- and short-circuit-protected
Reverse voltage protection	Yes

## Physical data

Width	35 mm / 1.378 inches
Height	30 mm / 1.181 inches
Depth	210 mm / 8.268 inches

### Mechanical Data

Weight	380 g
Conformity marking	CE

### Environmental requirements

Ambient temperature (operation)	-25 ... +70 °C
Surrounding air temperature (storage)	-40 ... +80 °C
Protection type	IP67
Protection class	III per EN 61140, IEC 61140, VDE 0140-1
Operating altitude	0 ... 2000 m / 0 ... 6562 ft
Pollution degree (5)	3 (EN 60664-1)
Overvoltage category	II (EN 60664-1)
Relative humidity (without condensation)	95 %
Vibration resistance	5g per IEC 60068-2-6
Shock resistance	Short-term: 50g/11 ms/half-sine per IEC 60068-2-27; Long-term: 30g/6 ms/half-sine per IEC 60068-2-29
EMC immunity to interference	per EN 61000-6-2
EMC emission of interference	per EN 61000-6-4

### Commercial data

ETIM 8.0	EC001599
ETIM 7.0	EC001599
PU (SPU)	1 pcs
Packaging type	Box
Country of origin	DE
GTIN	4055143949774
Customs tariff number	85371098990

### Downloads



#### Environmental Product Compliance

##### Compliance Search

Environmental Product  
Compliance  
765-1104/100-000



### Documentation

Manual				System Description		
Product Manual 8-Channel Digital Input/Output; Profinet	V 2.2.0 19.07.2022	pdf 7415.89 KB		WAGO I/O System Field; General Product Information	pdf 1009.23 KB	

Instruction Leaflet			
I/O System Field package insert	15.12.2021	pdf 1083.98 KB	<a href="#">↓</a>

### CAD/CAE-Data

CAD data			
2D/3D Models 765-1104/100-000			<a href="#">↓</a>

CAE data	
EPLAN Data Portal 765-1104/100-000	<a href="#">↓</a>
ZUKEN Portal 765-1104/100-000	<a href="#">↓</a>

### Runtime Software

Firmware			
0765-x1xx, Profinet IO-Field	V 02 23.07.2021	zip 1556.58 KB	<a href="#">↓</a>

### Libraries

Device Description File			
750-916; GSD-Dateien der Version 2.x für PRO-FINET/ Serie 750/753, 765, 767 und 852	2.9 15.10.2021	zip 2455.88 KB	<a href="#">↓</a>
Gerätebeschreibungsdateien 765-41xx, 765-11xx, PROFINET	V1_1_0_20	zip 26.83 KB	<a href="#">↓</a>

### 1 Compatible Products

#### 1.1 Required Accessories

##### 1.1.1 Cover

##### 1.1.1.1 Cover



[Item No.: 756-8103](#)  
M12 protective cap; for unused plugs

[Item No.: 756-8102](#)  
M12 protective cap; for unused sockets

##### 1.1.2 Marking

### 1.1.2.1 Marker



**Item No.: 2009-115**

WMB-Inline; for Smart Printer; 1500 pieces on roll; stretchable 5 - 5.2 mm; plain; snap-on type; white

### 1.1.2.2 Marking strip



**Item No.: 2009-110**

Marking strips; for Smart Printer; on reel; not stretchable; plain; snap-on type; white

### 1.1.3 Tool

#### 1.1.3.1 Assembly tool



**Item No.: 206-701**

Torque wrench M8 and M12; Assembly kit

### 1.2 Optional Accessories

#### 1.2.1 Cables and connectors

##### 1.2.1.1 Adapter



**Item No.: 756-9503/040-000**

Accessories; 4-pole



**Item No.: 756-9504/040-000**

Accessories; 4-pole

##### 1.2.1.2 Configurable connectors



**Item No.: 756-9205/040-000**

Fitted pluggable connector; 4-pole; M12 plug, right angle; Spring



**Item No.: 756-9202/040-000**

Fitted pluggable connector; 4-pole; M12 plug, straight, A-coded; Spring



**Item No.: 756-9701/050-000**

Fitted pluggable connector; 5-pole, shielded; M12 plug, straight; IDC technology



**Item No.: 756-9711/050-000**

Fitted pluggable connector; 5-pole, shielded; M12 socket, straight; IDC technology

##### 1.2.1.3 Configurable shielded connectors



**Item No.: 756-9501/040-000**

Accessories; M12 plug, right angle; 4-pole



**Item No.: 756-9501/060-000**

Fitted pluggable connector; 4-pole, shielded; M12 plug, straight, D-coded; Spring













1.2.1.4 Distribution connector

 <p><b>Item No.: 756-9301/040-000</b> Accessories; 4-pole</p>	 <p><b>Item No.: 756-9301/050-000</b> Accessories; 5-pole</p>	 <p><b>Item No.: 756-5517/040-010</b> Sensor/Actuator cable; 2xM12 socket; angled; M12A plug; straight; 4-pole; Length: 1 m</p>	 <p><b>Item No.: 756-5517/040-020</b> Sensor/Actuator cable; 2xM12 socket; angled; M12A plug; straight; 4-pole; Length: 2 m</p>
 <p><b>Item No.: 756-5516/040-010</b> Sensor/Actuator cable; 2xM12 socket; straight; M12A plug; straight; 4-pole; Length: 1 m</p>	 <p><b>Item No.: 756-5516/040-020</b> Sensor/Actuator cable; 2xM12 socket; straight; M12A plug; straight; 4-pole; Length: 2 m</p>	 <p><b>Item No.: 756-5514/040-010</b> Sensor/Actuator cable; 2xM8 socket; angled; M12A plug; straight; 4-pole; Length: 1 m</p>	 <p><b>Item No.: 756-5514/040-020</b> Sensor/Actuator cable; 2xM8 socket; angled; M12A plug; straight; 4-pole; Length: 2 m</p>
 <p><b>Item No.: 756-5513/040-010</b> Sensor/Actuator cable; 2xM8 socket; straight; M12A plug; straight; 4-pole; Length: 1 m</p>	 <p><b>Item No.: 756-5513/040-020</b> Sensor/Actuator cable; 2xM8 socket; straight; M12A plug; straight; 4-pole; Length: 2 m</p>		

1.2.1.5 ETHERNET/PROFINET cable

 <p><b>Item No.: 756-1202/060-100</b> ETHERNET cable; M12D plug; angled; 4-pole; Length: 10 m</p>	 <p><b>Item No.: 756-1202/060-020</b> ETHERNET cable; M12D plug; angled; 4-pole; Length: 2 m</p>	 <p><b>Item No.: 756-1202/060-200</b> ETHERNET cable; M12D plug; angled; 4-pole; Length: 20 m</p>	 <p><b>Item No.: 756-1202/060-050</b> ETHERNET cable; M12D plug; angled; 4-pole; Length: 5 m</p>
 <p><b>Item No.: 756-1204/060-010</b> ETHERNET cable; M12D plug; angled; M12D plug; angled; 4-pole; Length: 1 m</p>	 <p><b>Item No.: 756-1204/060-100</b> ETHERNET cable; M12D plug; angled; M12D plug; angled; 4-pole; Length: 10 m</p>	 <p><b>Item No.: 756-1204/060-020</b> ETHERNET cable; M12D plug; angled; M12D plug; angled; 4-pole; Length: 2 m</p>	 <p><b>Item No.: 756-1204/060-200</b> ETHERNET cable; M12D plug; angled; M12D plug; angled; 4-pole; Length: 20 m</p>
 <p><b>Item No.: 756-1204/060-030</b> ETHERNET cable; M12D plug; angled; M12D plug; angled; 4-pole; Length: 3 m</p>	 <p><b>Item No.: 756-1204/060-050</b> ETHERNET cable; M12D plug; angled; M12D plug; angled; 4-pole; Length: 5 m</p>	 <p><b>Item No.: 756-1201/060-100</b> ETHERNET cable; M12D plug; straight; 4-pole; Length: 10 m</p>	 <p><b>Item No.: 756-1201/060-020</b> ETHERNET cable; M12D plug; straight; 4-pole; Length: 2 m</p>
 <p><b>Item No.: 756-1201/060-200</b> ETHERNET cable; M12D plug; straight; 4-pole; Length: 20 m</p>	 <p><b>Item No.: 756-1201/060-050</b> ETHERNET cable; M12D plug; straight; 4-pole; Length: 5 m</p>	 <p><b>Item No.: 756-1203/060-100</b> ETHERNET cable; M12D plug; straight; M12D plug; straight; 4-pole; Length: 10 m</p>	 <p><b>Item No.: 756-1203/060-020</b> ETHERNET cable; M12D plug; straight; M12D plug; straight; 4-pole; Length: 2 m</p>
 <p><b>Item No.: 756-1203/060-200</b> ETHERNET cable; M12D plug; straight; M12D plug; straight; 4-pole; Length: 20 m</p>	 <p><b>Item No.: 756-1203/060-050</b> ETHERNET cable; M12D plug; straight; M12D plug; straight; 4-pole; Length: 5 m</p>		







1.2.1.6 Power cable

 <p><b>Item No.: 756-3504/050-100</b> Power cable; M12L plug; angled; 5-pole; Length: 10 m</p>	 <p><b>Item No.: 756-3504/050-150</b> Power cable; M12L plug; angled; 5-pole; Length: 15 m</p>	 <p><b>Item No.: 756-3504/050-020</b> Power cable; M12L plug; angled; 5-pole; Length: 2 m</p>	 <p><b>Item No.: 756-3504/050-050</b> Power cable; M12L plug; angled; 5-pole; Length: 5 m</p>
 <p><b>Item No.: 756-3504/050-075</b> Power cable; M12L plug; angled; 5-pole; Length: 7.5 m</p>	 <p><b>Item No.: 756-3503/050-100</b> Power cable; M12L plug; straight; 5-pole; Length: 10 m</p>	 <p><b>Item No.: 756-3503/050-150</b> Power cable; M12L plug; straight; 5-pole; Length: 15 m</p>	 <p><b>Item No.: 756-3503/050-020</b> Power cable; M12L plug; straight; 5-pole; Length: 2 m</p>
 <p><b>Item No.: 756-3503/050-050</b> Power cable; M12L plug; straight; 5-pole; Length: 5 m</p>	 <p><b>Item No.: 756-3503/050-075</b> Power cable; M12L plug; straight; 5-pole; Length: 7.5 m</p>	 <p><b>Item No.: 756-3502/050-100</b> Power cable; M12L socket; angled; 5-pole; Length: 10 m</p>	 <p><b>Item No.: 756-3502/050-150</b> Power cable; M12L socket; angled; 5-pole; Length: 15 m</p>

1.2.1.6 Power cable

 <b>Item No.: 756-3502/050-020</b> Power cable; M12L socket; angled; 5-pole; Length: 2 m	 <b>Item No.: 756-3502/050-050</b> Power cable; M12L socket; angled; 5-pole; Length: 5 m	 <b>Item No.: 756-3502/050-075</b> Power cable; M12L socket; angled; 5-pole; Length: 7.5 m	 <b>Item No.: 756-3506/050-003</b> Power cable; M12L socket; angled; M12L plug; angled; 5-pole; Length: 0.3 m
 <b>Item No.: 756-3506/050-005</b> Power cable; M12L socket; angled; M12L plug; angled; 5-pole; Length: 0.5 m	 <b>Item No.: 756-3506/050-010</b> Power cable; M12L socket; angled; M12L plug; angled; 5-pole; Length: 1 m	 <b>Item No.: 756-3506/050-100</b> Power cable; M12L socket; angled; M12L plug; angled; 5-pole; Length: 10 m	 <b>Item No.: 756-3506/050-150</b> Power cable; M12L socket; angled; M12L plug; angled; 5-pole; Length: 15 m
 <b>Item No.: 756-3506/050-020</b> Power cable; M12L socket; angled; M12L plug; angled; 5-pole; Length: 2 m	 <b>Item No.: 756-3506/050-050</b> Power cable; M12L socket; angled; M12L plug; angled; 5-pole; Length: 5 m	 <b>Item No.: 756-3506/050-075</b> Power cable; M12L socket; angled; M12L plug; angled; 5-pole; Length: 7.5 m	 <b>Item No.: 756-3501/050-100</b> Power cable; M12L socket; straight; 5-pole; Length: 10 m
 <b>Item No.: 756-3501/050-150</b> Power cable; M12L socket; straight; 5-pole; Length: 15 m	 <b>Item No.: 756-3501/050-020</b> Power cable; M12L socket; straight; 5-pole; Length: 2 m	 <b>Item No.: 756-3501/050-050</b> Power cable; M12L socket; straight; 5-pole; Length: 5 m	 <b>Item No.: 756-3501/050-075</b> Power cable; M12L socket; straight; 5-pole; Length: 7.5 m
 <b>Item No.: 756-3505/050-003</b> Power cable; M12L socket; straight; M12L plug; straight; 5-pole; Length: 0.3 m	 <b>Item No.: 756-3505/050-005</b> Power cable; M12L socket; straight; M12L plug; straight; 5-pole; Length: 0.5 m	 <b>Item No.: 756-3505/050-010</b> Power cable; M12L socket; straight; M12L plug; straight; 5-pole; Length: 1 m	 <b>Item No.: 756-3505/050-100</b> Power cable; M12L socket; straight; M12L plug; straight; 5-pole; Length: 10 m
 <b>Item No.: 756-3505/050-150</b> Power cable; M12L socket; straight; M12L plug; straight; 5-pole; Length: 15 m	 <b>Item No.: 756-3505/050-020</b> Power cable; M12L socket; straight; M12L plug; straight; 5-pole; Length: 2 m	 <b>Item No.: 756-3505/050-050</b> Power cable; M12L socket; straight; M12L plug; straight; 5-pole; Length: 5 m	 <b>Item No.: 756-3505/050-075</b> Power cable; M12L socket; straight; M12L plug; straight; 5-pole; Length: 7.5 m

1.2.1.7 Sensor/actuator cable

 <b>Item No.: 756-5312/040-015</b> Sensor/Actuator cable; M12A plug; angled; 4-pole; Length: 1.5 m	 <b>Item No.: 756-5312/040-100</b> Sensor/Actuator cable; M12A plug; angled; 4-pole; Length: 10 m	 <b>Item No.: 756-5312/040-050</b> Sensor/Actuator cable; M12A plug; angled; 4-pole; Length: 5 m	 <b>Item No.: 756-5311/040-015</b> Sensor/Actuator cable; M12A plug; straight; 4-pole; Length: 1.5 m
 <b>Item No.: 756-5311/040-100</b> Sensor/Actuator cable; M12A plug; straight; 4-pole; Length: 10 m	 <b>Item No.: 756-5311/040-050</b> Sensor/Actuator cable; M12A plug; straight; 4-pole; Length: 5 m	 <b>Item No.: 756-5404/040-010</b> Sensor/Actuator cable; M12A socket; angled; M12A plug; angled; 4-pole; Length: 1 m	 <b>Item No.: 756-5404/040-020</b> Sensor/Actuator cable; M12A socket; angled; M12A plug; angled; 4-pole; Length: 2 m
 <b>Item No.: 756-5403/040-010</b> Sensor/Actuator cable; M12A socket; angled; M12A plug; straight; 4-pole; Length: 1 m	 <b>Item No.: 756-5403/040-020</b> Sensor/Actuator cable; M12A socket; angled; M12A plug; straight; 4-pole; Length: 2 m	 <b>Item No.: 756-5402/040-010</b> Sensor/Actuator cable; M12A socket; straight; M12A plug; angled; 4-pole; Length: 1 m	 <b>Item No.: 756-5402/040-020</b> Sensor/Actuator cable; M12A socket; straight; M12A plug; angled; 4-pole; Length: 2 m
 <b>Item No.: 756-5401/040-010</b> Sensor/Actuator cable; M12A socket; straight; M12A plug; straight; 4-pole; Length: 1 m	 <b>Item No.: 756-5401/040-020</b> Sensor/Actuator cable; M12A socket; straight; M12A plug; straight; 4-pole; Length: 2 m	 <b>Item No.: 756-5510/040-010</b> Sensor/Actuator cable; M8 socket; angled; M12A plug; angled; 4-pole; Length: 1 m	 <b>Item No.: 756-5510/040-020</b> Sensor/Actuator cable; M8 socket; angled; M12A plug; angled; 4-pole; Length: 2 m
 <b>Item No.: 756-5509/040-010</b> Sensor/Actuator cable; M8 socket; angled; M12A plug; straight; 4-pole; Length: 1 m	 <b>Item No.: 756-5509/040-020</b> Sensor/Actuator cable; M8 socket; angled; M12A plug; straight; 4-pole; Length: 2 m	 <b>Item No.: 756-5508/040-010</b> Sensor/Actuator cable; M8 socket; straight; M12A plug; angled; 4-pole; Length: 1 m	 <b>Item No.: 756-5508/040-020</b> Sensor/Actuator cable; M8 socket; straight; M12A plug; angled; 4-pole; Length: 2 m

1.2.1.7 Sensor/actuator cable



Item No.: 756-5507/040-010

Sensor/Actuator cable; M8 socket;  
straight; M12A plug; straight; 4-pole;  
Length: 1 m

Item No.: 756-5507/040-020

Sensor/Actuator cable; M8 socket;  
straight; M12A plug; straight; 4-pole;  
Length: 2 m