

B26 B22d

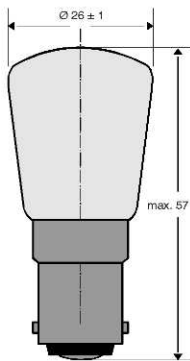

B26 Ba15d24

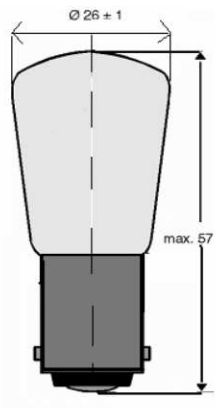

B26 Ba15d19

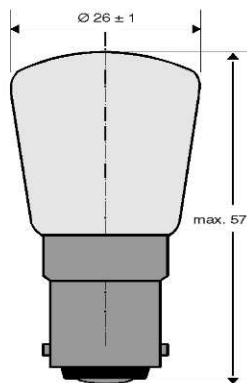

B26 Ba15s

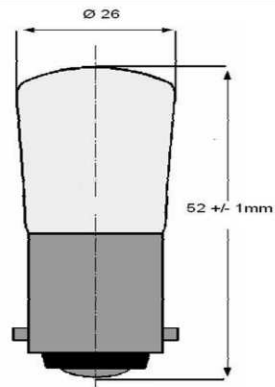

B26 BA20d

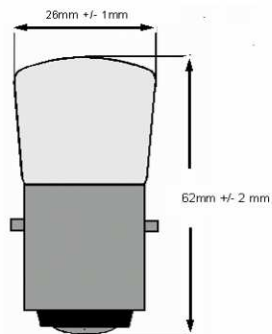

B26 BAY15d

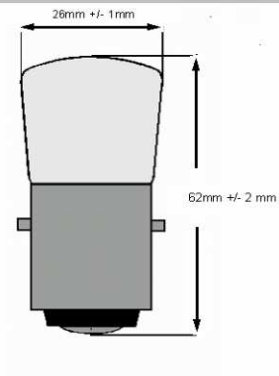

B26 BX22d/32

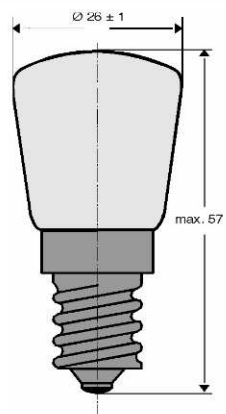

B26 E14

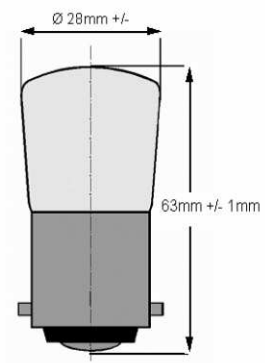

B28 B22d

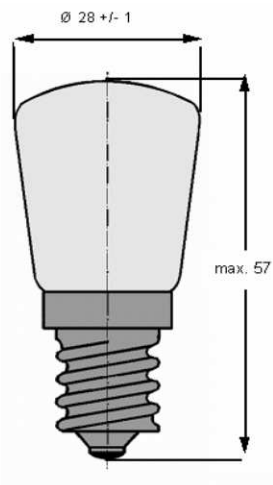

B28 E14

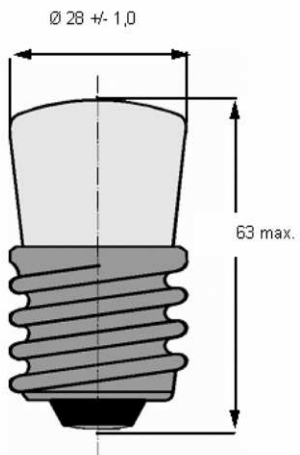

B28 E27

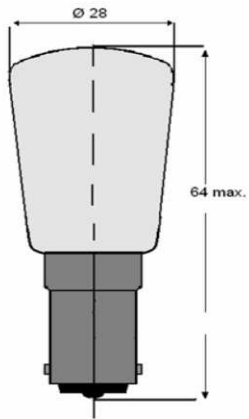

B28x64 - BA15d/24

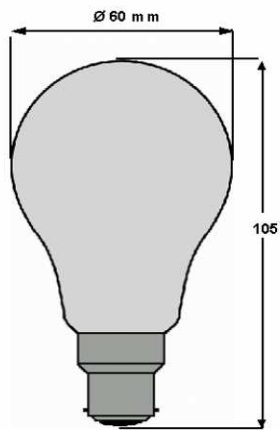

B60 B22d

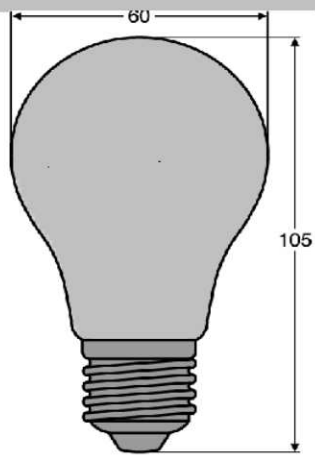

B60 E27