

BAUREIHE 1830 - EIN- UND ZWEIPOLIGE WIPPSCHALTER

BIS 20 (4) A 250 V AC



PRODUKTMERKMALE

- ◆ 100-millionenfach bewährtes Schaltprinzip
- ◆ Mechanische Lebensdauer bis 1 Mio. Schaltzyklen
- ◆ Hohe Variantenvielfalt
- ◆ Varianten mit IP 67 oder Staubschutzeinlage
- ◆ Zwei Gehäusevarianten
- ◆ Ausgeprägte Betätigungscharakteristik
- ◆ Beleuchtete und unbeleuchtete Varianten
- ◆ Zulassung für 400 V (produktabhängig)

AUF ANFRAGE

- ◆ Weitere Farben
- ◆ Weitere Wippenbedruckungen
- ◆ Weitere Leuchtenvarianten
- ◆ Aufrastbare kundenspezifische Betätiger
- ◆ Kabelkonfektion

Mechanische Lebensdauer	10E4 5E4 (Grundtyp 1839) 1E6 (produktabhängig)
Einschaltspitzenstrom (Kapazitiv)	120 A / 50 A (Kontaktpaarung Ag / Cu und Grundtyp 1834)
Übergangswiderstand (Neuzustand)	< 100 mOhm (1 A 12 V DC)
Isolationswiderstand (Neuzustand)	> 100 MOhm (500 V DC)
Kriechstromfestigkeit	250 PTI
Schutzart	IP 40 / IP 67 (produktabhängig)
Temperaturbereich	Anschlussseite -20 °C ... +105 °C / ... +85 °C / ... +100 °C Betätigungsseite -20 °C ... +55 °C
Entflammbarkeit	UL 94 V-2 UL 94 V-0
Glühdrahttesttemperatur	850 °C
Material	Betätiger PA / PC Gehäuse PA Anschlüsse versilbert / verzinkt
Aufsteckkraft der Steckhülsen	≤ 80 N
Prüfzeichen	
Geeignet für Geräte der Schutzklasse II	



WIPPSCHALTER

DRUCKSCHALTER

KIPPSCHALTER

SCHIEBESCHALTER

DREHSCHALTER

FLUSSSCHALTER

TASTEN

SCHNAPPSCHALTER

MIKRO-SIGNALSCHALTER

SENSOREN

BAUREIHE 1830 - EIN- UND ZWEIPOLIGE WIPPSCHALTER

BIS 20 (4) A 250 V AC

	Ausschalter (SPST)							Wechsler (SPDT Momentary)						
	1830.3111	1830.3112	1830.3118	1830.3119	1830.8112	1830.0102	1830.6103	1835.3902	1831.0114	1831.3312	1831.3313	1831.3317	1831.3606	1831.3607
Spannung Beleuchtung in V	230	230	230	230	230	230	230	230						
Betätigerfarbe / Bedruckung														
Gehäusefarbe														
20 (4) A 250 V AC 1E4	•	•	•	•	•				•	•	•	•	•	•
20 (4) A 250 V AC														
16 (4) A 250 V AC 1E4														
10 (8) A 400 V AC 5E4														
10 (8) A 250 V AC 5E4	•	•	•	•	•				•	•	•	•	•	•
10 (4) A 250 V AC 1E4							•	•						
10 A 12 V DC														
6 (4) A 250 V AC 5E4							•	•						
6 (4) A 250 V AC 1E4														
6 (4) A 250 V AC														
4 (2) A 250 V AC 1E4								•						
30 mA 12 V DC														
16 A 250 V AC 1 HP	•	•	•	•	•				•	•	•	•	•	•
16 A 125 V AC 1 HP														
16 A 250 V AC 1/2 HP														
16 A 125 V AC 1/3 HP									•	•	•	•	•	•
16 A 125 V AC 1/4 HP														
6 A 250 V AC 1/2 HP							•	•						
6 A 125 V AC 1/4 HP														
6 A 125 - 250 V AC 1/8 HP														
6 A 125 V AC 1/10 HP								•						
4 A 250 V AC 1/10 HP								•						
Anschlussart														
Anschlussbeschreibung	6.3	6.3	6.3	6.3	6.3		4.8	6.3		6.3	6.3	6.3	6.3	6.3
Kontaktabstand in mm	≥ 3	≥ 3	≥ 3	≥ 3	≥ 3	≥ 3	≥ 3	≥ 3	≥ 3	≥ 3	≥ 3	≥ 3	≥ 3	≥ 3
Kontaktmaterial	Ag	Ag	Ag	Ag	Ag	Ag	Ag	Ag	Ag	Ag	Ag	Ag	Ag	Ag
EN 60335 Kap. 30 konform „G“				•								•	•	•
Sonstiges					tieferliegender Flansch		tieferliegender Flansch	externer Leuchtenanschluss zweipolige Baugröße					Gehäuse mit 2 Trennstegen	Gehäuse mit 2 Trennstegen
Lagervariante		•	•							•	•			

WIPPSCHALTER

DRUCKSCHALTER

KIPPSCHALTER

SCHIEBESCHALTER

DREHSCHALTER

FUSSSCHALTER

TASTEN





























SCHNAPPSCHALTER

MIKRO-SIGNALSCHALTER

SENSOREN

BAUREIHE 1830 - EIN- UND ZWEIPOLIGE WIPPSCHALTER

BIS 20 (4) A 250 V AC

	Ausschalter (SPST)						Schließer (SPNO)				Umschalter (SPDT)			
	1831.3815	1831.3933	1831.8112	1832.3508	1831.3311	1831.1107	1831.1202	1831.3402	1831.8202	1831.1253	1833.3312	1833.1102	1833.3307	1833.7102
Spannung Beleuchtung in V														
Betätigerfarbe / Bedruckung														
Gehäusefarbe	black	black	black	black	black	black	black	black	black	black	black	black	black	black
20 (4) A 250 V AC 1E4	•	•	•	•										
20 (4) A 250 V AC					•									
16 (4) A 250 V AC 1E4										•				
10 (8) A 400 V AC 5E4														
10 (8) A 250 V AC 5E4	•	•	•	•	•									
10 (4) A 250 V AC 1E4						•						•	•	•
10 A 12 V DC														
6 (4) A 250 V AC 5E4						•						•	•	•
6 (4) A 250 V AC 1E4														
6 (4) A 250 V AC														
4 (2) A 250 V AC 1E4							•	•	•					
30 mA 12 V DC									•					
16 A 250 V AC 1 HP	•	•	•	•	•									
16 A 125 V AC 1 HP											•			
16 A 250 V AC 1/2 HP	•	•	•	•	•									
16 A 125 V AC 1/3 HP										•				
16 A 125 V AC 1/4 HP											•			
6 A 250 V AC 1/2 HP						•						•	•	•
6 A 125 V AC 1/4 HP							•					•	•	•
6 A 125 - 250 V AC 1/8 HP														
6 A 125 V AC 1/10 HP							•	•	•					
4 A 250 V AC 1/10 HP							•	•	•					
Anschlussart														
Anschlussbeschreibung	6.3	6.3	6.3	6.3	6.3	4.8	4.8	6.3	6.3	4.8	6.3	4.8	6.3	4.8
Kontaktabstand in mm	≥ 3	≥ 3	≥ 3	≥ 3	≥ 3	≥ 3	≥ 3	≥ 3	≥ 3	≥ 3	≥ 3	≥ 3	≥ 3	≥ 3
Kontaktmaterial	Ag	Ag	Ag	Ag	Ag	Ag	Ag	Ag	Ag	Au	Ag	Ag	Ag	Ag
EN 60335 Kap. 30 konform „G“					•							•		
Sonstiges	1E6 mechanische Schaltzyklen IP 67		tieferliegender Flansch	zweipolige Baugröße					tieferliegender Flansch					tieferliegender Flansch
Lagervariante			•	•	•		•	•						

WIPPSCHALTER

DRUCKSCHALTER

KIPPSCHALTER

SCHIEBESCHALTER

DREHSCHALTER

FUSSSCHALTER

TASTEN











































SCHNAPPSCHALTER

MIKRO-SIGNALSCHALTER

SENSOREN

BAUREIHE 1830 - EIN- UND ZWEIPOLIGE WIPPSCHALTER











































BIS 20 (4) A 250 V AC

zweipolig		Ausschalter (DPST)										Umschalter (DPDT)		Ausschalter (DPST)		
		1835.3419	1835.3111	1835.3112	1835.3114	1835.3118	1835.9413	1835.3102	1835.3105	1835.3108	1835.7108	1835.3802	1835.3116	1835.3107	1832.1612	
Spannung Beleuchtung in V		400	230	230	230	230	230	230	230	230	230	230	115-230	12		
Betätigerfarbe / Bedruckung																
Gehäusefarbe																
20 (4) A 250 V AC 1E4		•	•	•	•	•	•						•		•	
20 (4) A 250 V AC																
16 (4) A 250 V AC 1E4																
10 (8) A 400 V AC 5E4		•														
10 (8) A 250 V AC 5E4		•	•	•	•	•	•						•		•	
10 (4) A 250 V AC 1E4								•	•	•	•	•				
10 A 12 V DC													•			
6 (4) A 250 V AC 5E4								•	•	•	•	•				
6 (4) A 250 V AC 1E4																
6 (4) A 250 V AC																
4 (2) A 250 V AC 1E4																
30 mA 12 V DC																
16 A 250 V AC 1 HP		•	•	•	•	•	•						•		•	
16 A 125 V AC 1 HP																
16 A 250 V AC 1/2 HP																
16 A 125 V AC 1/3 HP															•	
16 A 125 V AC 1/4 HP																
6 A 250 V AC 1/2 HP								•	•	•	•	•				
6 A 125 V AC 1/4 HP																
6 A 125 - 250 V AC 1/8 HP																
6 A 125 V AC 1/10 HP																
4 A 250 V AC 1/10 HP																
Anschlussart																
Anschlussbeschreibung		6.3	6.3	6.3	6.3	6.3		6.3	6.3	6.3	6.3	6.3	6.3	6.3	4.8	
Kontaktabstand in mm		≥ 3	≥ 3	≥ 3	≥ 3	≥ 3	≥ 3	≥ 3	≥ 3	≥ 3	≥ 3	≥ 3	≥ 3	≥ 3	≥ 3	
Kontaktmaterial		Ag	Ag	Ag	Ag	Ag	Ag	Ag	Ag	Ag	Ag	Ag	Ag	Ag	Ag	
EN 60335 Kap. 30 konform „G“																
Sonstiges		Abdeckrahmen 33.2 lang					LPL-Halterung 248.103.011 montiert tieferliegender Flansch				tieferliegender Flansch				Abdeckrahmen 33.2 lang	
Lagervariante				•	•	•		•	•	•						

WIPPSCHALTER
DRUCKSCHALTER
KIPPSCHALTER
SCHIEBESCHALTER
DREHSCHALTER
FUSSSCHALTER
TASTEN
SCHNAPPSCHALTER
MIKRO-SIGNALSCHALTER
SENSOREN

BAUREIHE 1830 - EIN- UND ZWEIPOLIGE WIPPSCHALTER

BIS 20 (4) A 250 V AC

zweipolig															
															
		Ausschalter (DPST)													
		1832.3311	1832.3312	1832.3313	1832.3602	1832.6112	1832.7103	1832.8112	1832.9103	1832.0113	1832.1102	1832.3307	1832.9101	Schließer (DPNO)	
Spannung Beleuchtung in V															
Betätigerfarbe / Bedruckung															
Gehäusefarbe															
20 (4) A 250 V AC 1E4		•	•	•	•	•	•	•	•						
20 (4) A 250 V AC															
16 (4) A 250 V AC 1E4										•					
10 (8) A 400 V AC 5E4															
10 (8) A 250 V AC 5E4		•	•	•	•	•	•	•	•						
10 (4) A 250 V AC 1E4											•	•	•		
10 A 12 V DC															
6 (4) A 250 V AC 5E4											•	•	•		
6 (4) A 250 V AC 1E4															
6 (4) A 250 V AC															
4 (2) A 250 V AC 1E4														•	•
30 mA 12 V DC															
16 A 250 V AC 1 HP		•	•	•	•	•	•	•	•						
16 A 125 V AC 1 HP									•						
16 A 250 V AC 1/2 HP										•					
16 A 125 V AC 1/3 HP		•	•	•	•	•	•	•							
16 A 125 V AC 1/4 HP										•					
6 A 250 V AC 1/2 HP											•	•	•		
6 A 125 V AC 1/4 HP											•	•	•		
6 A 125 - 250 V AC 1/8 HP															
6 A 125 V AC 1/10 HP														•	•
4 A 250 V AC 1/10 HP														•	•
Anschlussart															
Anschlussbeschreibung		6.3	6.3	6.3	6.3	4.8	≥ 3	6.3	≥ 3	≥ 3	4.8	6.3	≥ 3	6.3	6.3
Kontaktabstand in mm		≥ 3	≥ 3	≥ 3	≥ 3	≥ 3	≥ 3	≥ 3	≥ 3	≥ 3	≥ 3	≥ 3	≥ 3	≥ 3	≥ 3
Kontaktmaterial		Ag	Ag	Ag	Ag	Ag	Ag	Ag	Ag	Ag	Ag	Ag	Ag	Ag	Ag
EN 60335 Kap. 30 konform „G“				•											
Sonstiges					Abdeckrahmen 33.2 lang	tieferliegender Flansch	tieferliegender Flansch	tieferliegender Flansch	tieferliegender Flansch	Staubschutzeinlage		tieferliegender Flansch			tieferliegender Flansch
Lagervariante		•	•		•						•	•			

WIPPSCHALTER

DRUCKSCHALTER

KIPPSCHALTER

SCHIEBESCHALTER

DREHSCHALTER

FUSSSCHALTER

TASTEN

SCHNAPPSCHALTER

MIKRO-SIGNALSCHALTER

SENSOREN

BAUREIHE 1830 - EIN- UND ZWEIPOLIGE WIPPSCHALTER

BIS 20 (4) A 250 V AC

zweipolig		Umschalter (DPDT)								Umschalter mit AUS-Stellung in der Mitte (DPDT - Center OFF)							
		1834.3311	1834.3312	1834.1102	1834.3302	1834.3309	1834.3603	1834.6103	1839.3512	1839.1402	1839.1407	1839.1410	1839.1502	1839.1507	1839.1509	1839.1518	
Spannung Beleuchtung in V																	
Betätigerfarbe / Bedruckung																	
Gehäusefarbe																	
20 (4) A 250 V AC 1E4																	
20 (4) A 250 V AC																	
16 (4) A 250 V AC 1E4		•	•						•								
10 (8) A 400 V AC 5E4																	
10 (8) A 250 V AC 5E4																	
10 (4) A 250 V AC 1E4				•	•	•	•	•									
10 A 12 V DC																	
6 (4) A 250 V AC 5E4				•	•	•	•	•									
6 (4) A 250 V AC 1E4										•	•	•	•	•	•	•	
6 (4) A 250 V AC																	
4 (2) A 250 V AC 1E4																	
30 mA 12 V DC																	
16 A 250 V AC 1 HP																	
16 A 125 V AC 1 HP																	
16 A 250 V AC 1/2 HP		•	•						•								
16 A 125 V AC 1/3 HP									•								
16 A 125 V AC 1/4 HP		•	•														
6 A 250 V AC 1/2 HP				•	•	•	•	•									
6 A 125 V AC 1/4 HP				•	•	•	•	•									
6 A 125 - 250 V AC 1/8 HP										•	•	•	•	•	•	•	
6 A 125 V AC 1/10 HP																	
4 A 250 V AC 1/10 HP																	
Anschlussart																	
Anschlussbeschreibung		6.3	6.3	4.8	6.3	6.3	6.3	4.8	6.3	6.3	4.8	4.8	4.8	4.8	4.8	4.8	
Kontaktabstand in mm		≥ 3	≥ 3	≥ 3	≥ 3	≥ 3	≥ 3	≥ 3	≥ 3	≥ 3	≥ 3	≥ 3	≥ 3	≥ 3	≥ 3	≥ 3	
Kontaktmaterial		Ag	Ag	Ag	Ag	Ag	Ag	Ag	Ag	Ag	Ag	Ag	Ag	Ag	Ag	Ag	
EN 60335 Kap. 30 konform „G“								•									
Sonstiges								Abdeckrahmen 33.2 lang tieferliegender Flansch			Tastfunktion beidseitig	Tastfunktion beidseitig	Tastfunktion beidseitig Staubschutzeinlage			Staubschutzeinlage	
Lagervariante					•						•	•		•			

WIPPSCHALTER
DRUCKSCHALTER
KIPPSCHALTER
SCHIEBESCHALTER
DREHSCHALTER
FUSSSCHALTER
TASTEN
SCHNAPPSCHALTER
MIKRO-SIGNALSCHALTER
SENSOREN

BAUREIHE 1830 - EIN- UND ZWEIPOLIGE WIPPSCHALTER

BIS 20 (4) A 250 V AC

zweipolig		Umschalter mit AUS-Stellung in der Mitte (DPDT - Center OFF)								Wechsler (DPDT Momentary)	
		1839.1602	1839.2203	1839.3402	1839.3502	1839.3503	1839.3602	1839.7304	1839.3352	1839.0105	1834.3402
Spannung Beleuchtung in V											
Betätigerfarbe / Bedruckung											
Gehäusefarbe											
20 (4) A 250 V AC 1E4											
20 (4) A 250 V AC											
16 (4) A 250 V AC 1E4											
10 (8) A 400 V AC 5E4											
10 (8) A 250 V AC 5E4											
10 (4) A 250 V AC 1E4											
10 A 12 V DC											
6 (4) A 250 V AC 5E4											
6 (4) A 250 V AC 1E4		•	•	•	•	•	•	•			
6 (4) A 250 V AC											
4 (2) A 250 V AC 1E4											•
30 mA 12 V DC								•			
16 A 250 V AC 1 HP											
16 A 125 V AC 1 HP											
16 A 250 V AC 1/2 HP											
16 A 125 V AC 1/3 HP											
16 A 125 V AC 1/4 HP											
6 A 250 V AC 1/2 HP											
6 A 125 V AC 1/4 HP											
6 A 125 - 250 V AC 1/8 HP		•	•	•	•	•	•	•			
6 A 125 V AC 1/10 HP											•
4 A 250 V AC 1/10 HP											•
Anschlussart											
Anschlussbeschreibung		4.8		6.3	6.3	6.3	6.3		6.3		6.3
Kontaktabstand in mm		≥ 3	≥ 3	≥ 3	≥ 3	≥ 3	≥ 3	≥ 3	≥ 3	≥ 3	≥ 3
Kontaktmaterial		Ag	Ag	Ag	Ag	Ag	Ag	Ag	Au	Ag	Ag
EN 60335 Kap. 30 konform „G“											
Sonstiges		Tastfunktion einseitig	Tastfunktion einseitig	Tastfunktion beidseitig			Tastfunktion einseitig	Tastfunktion einseitig Staubschutzeinlage tieferliegender Flansch	Tastfunktion beidseitig Abdeckrahmen 33.2 lang	Staubschutzeinlage	
Lagervariante				•							

WIPPSCHALTER

DRUCKSCHALTER

KIPPSCHALTER

SCHIEBESCHALTER

DREHSCHALTER

FUSSSCHALTER

TASTEN

















SCHNAPPSCHALTER

MIKRO-SIGNALSCHALTER

SENSOREN

BAUREIHE 1830 - EIN- UND ZWEIPOLIGE WIPPSCHALTER

BIS 20 (4) A 250 V AC

Leuchte	Leuchte				
	1837.118	1837.2504	1837.3102	1837.8102	1837.8108
					
Spannung Beleuchtung in V	230	230	230	230	230
Betätigerfarbe / Bedruckung					
Gehäusefarbe					
20 (4) A 250 V AC 1E4					
20 (4) A 250 V AC					
16 (4) A 250 V AC 1E4					
10 (8) A 400 V AC 5E4					
10 (8) A 250 V AC 5E4					
10 (4) A 250 V AC 1E4					
10 A 12 V DC					
6 (4) A 250 V AC 5E4					
6 (4) A 250 V AC 1E4					
6 (4) A 250 V AC					
4 (2) A 250 V AC 1E4					
30 mA 12 V DC					
16 A 250 V AC 1 HP					
16 A 125 V AC 1 HP					
16 A 250 V AC 1/2 HP					
16 A 125 V AC 1/3 HP					
16 A 125 V AC 1/4 HP					
6 A 250 V AC 1/2 HP					
6 A 125 V AC 1/4 HP					
6 A 125 - 250 V AC 1/8 HP					
6 A 125 V AC 1/10 HP					
4 A 250 V AC 1/10 HP					
Anschlussart					
Anschlussbeschreibung	4.8		6.3	6.3	6.3
Kontaktabstand in mm					
Kontaktmaterial					
EN 60335 Kap. 30 konform „G“					
Sonstiges		tieferliegender Flansch		Baugröße Grundtyp 1835	Baugröße Grundtyp 1835
Lagervariante					

WIPPSCHALTER

DRUCKSCHALTER

KIPPSCHALTER

SCHIEBESCHALTER

DREHSCHALTER

FUSSSCHALTER

TASTEN

SCHNAPPSCHALTER

MIKRO-SIGNALSCHALTER

SENSOREN

BAUREIHE 1830 - EIN- UND ZWEIPOLIGE WIPPSCHALTER

BIS 20 (4) A 250 V AC



Grundtypen 1830, 1831, 1833
und 1838
einpolig
beleuchtet / unbeleuchtet

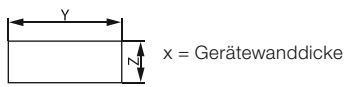

X	Y	Z
0.75 ... 1.25	30 ^{-0.1}	11 ^{+0.1}
1.25 ... 2	30.2 ^{-0.1}	11 ^{+0.1}
2 ... 3	30.6 ^{-0.1}	11 ^{+0.1}

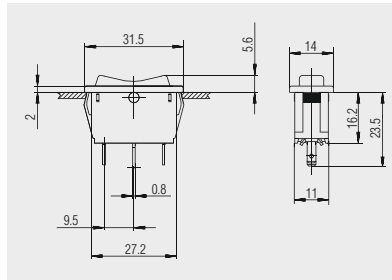

Steckanschluss 2.8 x 0.8
1838.4307

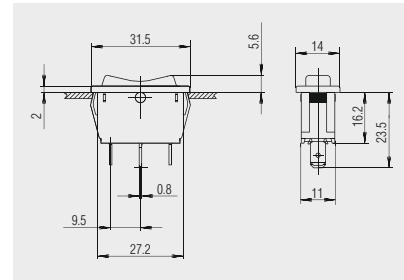

Steckanschluss 4.8 x 0.8
Grundtyp 1838

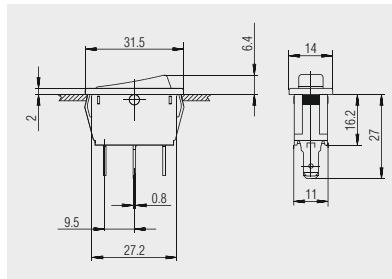

Steckanschluss 4.8 x 0.8
Grundtypen 1830, 1831 und 1833

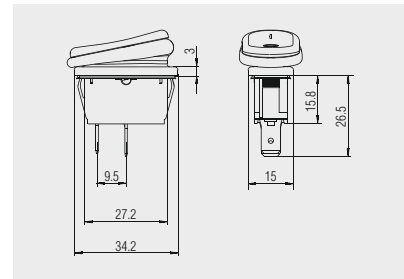

Steckanschluss 6.3 x 0.8
1831.3815

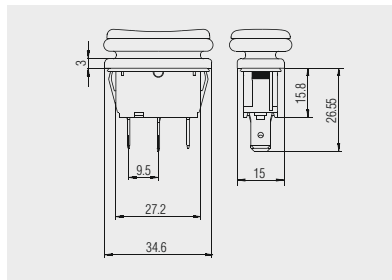

Steckanschluss 6.3 x 0.8
1838.3901

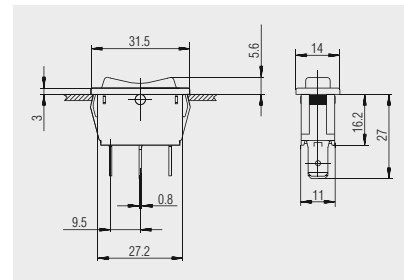

Steckanschluss 6.3 x 0.8
Grundtyp 1838

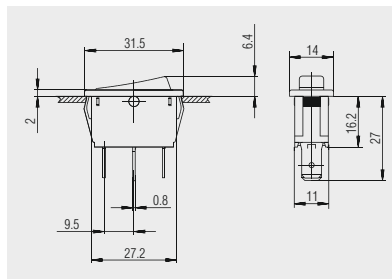

Steckanschluss 6.3 x 0.8
Grundtypen 1831 und 1833

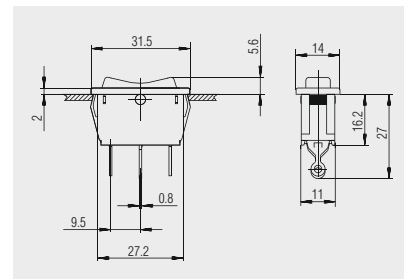

Lötanschluss
Grundtyp 1838

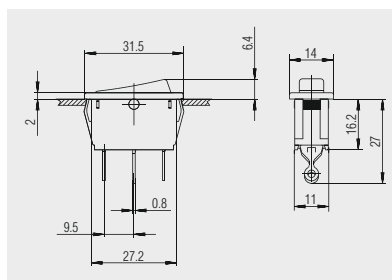

Lötanschluss
Grundtypen 1830 und 1831

BAUREIHE 1830 - EIN- UND ZWEIPOLIGE WIPPSCHALTER

BIS 20 (4) A 250 V AC



Grundtypen 1832, 1834, 1835
und 1839
zweipolig
beleuchtet / unbeleuchtet

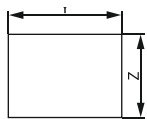

X = Gerätewanddicke

X	Y	Z
0.75 ... 1.25	30 ^{-0.1}	22 ^{+0.2}
1.25 ... 2	30.2 ^{-0.1}	22 ^{+0.2}
2 ... 3	30.6 ^{-0.1}	22 ^{+0.2}

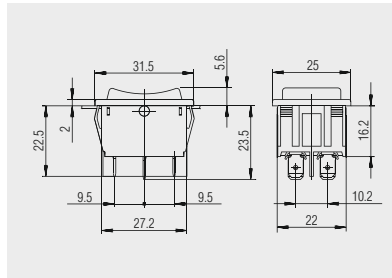

Steckanschluss 4.8 x 0.8

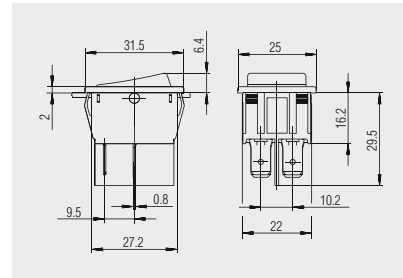

Steckanschluss 6.3 x 0.8 / 4.8
Grundtypen 1832, 1834 und 1835

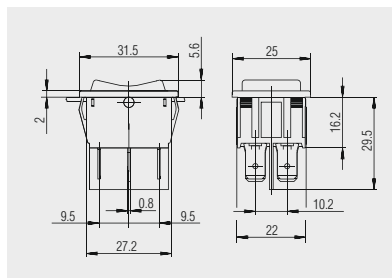

Steckanschluss 6.3 x 0.8
Grundtyp 1839

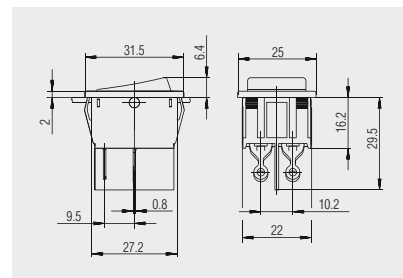

Lötanschluss
Grundtyp 1832

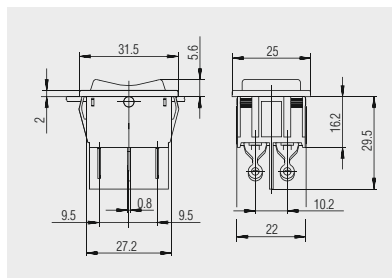

Lötanschluss
Grundtyp 1839

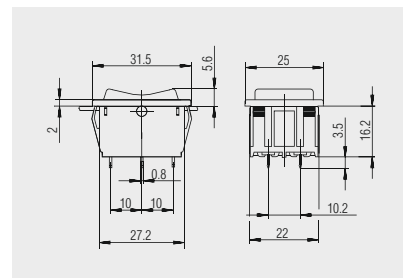

Leiterplattenanschluss
Grundtyp 1839



Grundtypen 1830, 1831 und 1833
einpilig, tieferliegender Flansch
beleuchtet / unbeleuchtet

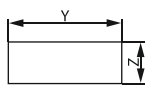

X = Gerätewanddicke

X	Y	Z
0.75 ... 1.25	30 ^{-0.1}	11 ^{+0.1}
1.25 ... 2	30.2 ^{-0.1}	11 ^{+0.1}
2 ... 3	30.6 ^{-0.1}	11 ^{+0.1}

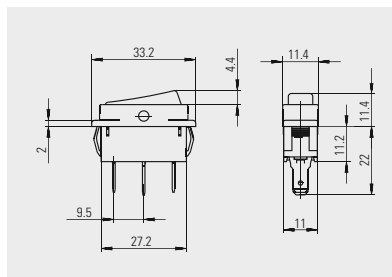

Steckanschluss 4.8 x 0.8
Grundtypen 1830, 1831 und 1833

WIPPSCHALTER

DRUCKSCHALTER

KIPPSCHALTER

SCHIEBESCHALTER

DREHSCHALTER

FUSSSCHALTER

TASTEN

SCHNAPPSCHALTER

MIKRO-SIGNALSCHALTER

SENSOREN

BAUREIHE 1830 - EIN- UND ZWEIPOLIGE WIPPSCHALTER

BIS 20 (4) A 250 V AC

WIPPSCHALTER

DRUCKSCHALTER

KIPPSCHALTER

SCHIEBESCHALTER

DREHSCHALTER

FUSSSCHALTER

TASTEN

SCHNAPPSCHALTER

MIKRO-SIGNALSCHALTER

SENSOREN



Grundtypen 1832, 1834, 1835 und 1839
zweipolig, tieferliegender Flansch
beleuchtet / unbeleuchtet

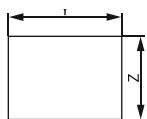

X = Gerätewanddicke

X	Y	Z
0.75 ... 1.25	30 ^{-0.1}	22 ^{+0.2}
1.25 ... 2	30.2 ^{-0.1}	22 ^{+0.2}
2 ... 3	30.6 ^{-0.1}	22 ^{+0.2}

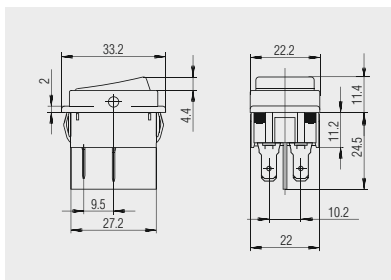

Steckanschluss 4.8 x 0.8
Grundtypen 1832 und 1834

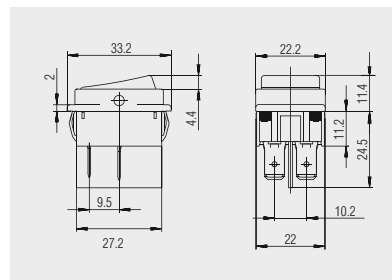

Steckanschluss 6.3 x 0.8
Grundtyp 1832

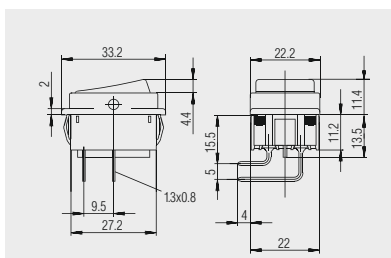

Leiterplattenanschluss
abgewinkelt
Grundtypen 1832 und 1835

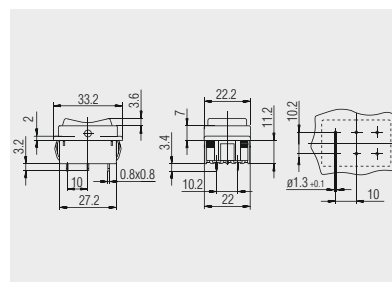

Leiterplattenanschluss
Grundtyp 1839

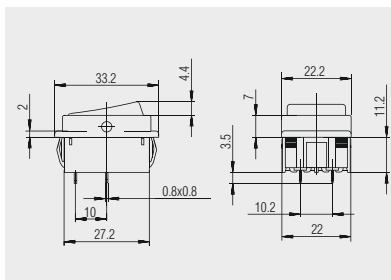

Leiterplattenanschluss
Grundtypen 1832 und 1835



Grundtyp 1837 Leuchte
ein- und zweipolig

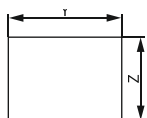

X = Gerätewanddicke

X	Y	Z
0.75 ... 1.25	30 ^{-0.1}	22 ^{+0.2}
1.25 ... 2	30.2 ^{-0.1}	22 ^{+0.2}
2 ... 3	30.6 ^{-0.1}	22 ^{+0.2}

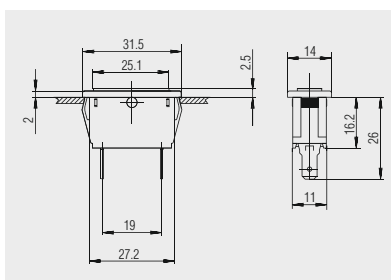

Steckanschluss 4.8 x 0.8
einpolige Baugröße

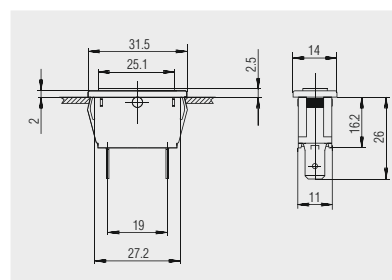

Steckanschluss 6.3 x 0.8
einpolige Baugröße

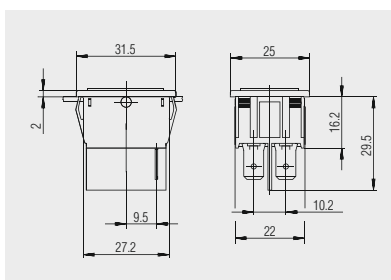

Steckanschluss 6.3 x 0.8
zweipolige Baugröße

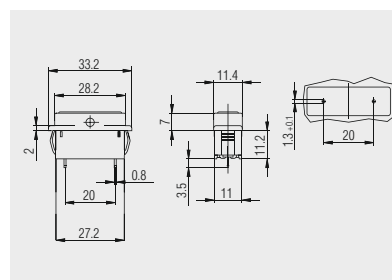

Leiterplattenanschluss
tieferliegender Flansch
1837.2504

BAUREIHE 1830 - EIN- UND ZWEIPOLIGE WIPPSCHALTER

BIS 20 (4) A 250 V AC



Schutzkappe
203.731.011

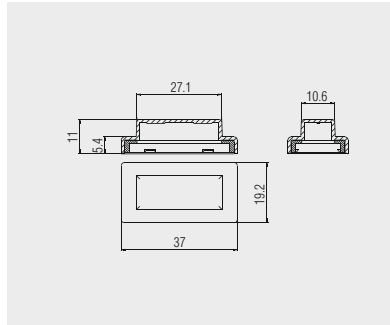

Transparente PVC-Schutzkappe für einpolige Schalter der Grundtypen 1830, 1831, 1833 und 1838. Dient als Staub- und Wasserschutz der Betätigungsseite.



Schutzkappe
203.201.011

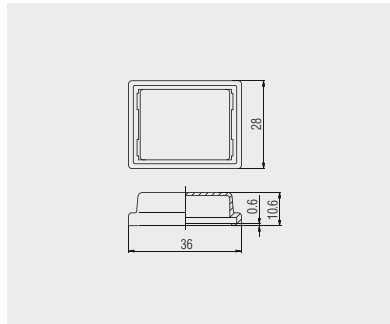

Transparente PVC-Schutzkappe für zweipolige Schalter der Grundtypen 1832, 1834, 1835 und 1839 mit Rahmenlänge 33.2 mm. Dient als Staub- und Wasserschutz der Betätigungsseite.



Schutzkappe
203.078.011

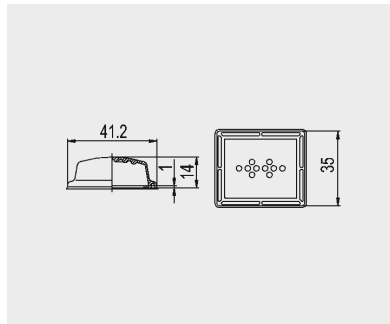

Transparente PVC-Schutzkappe mit Noppen. Dient als Staub- und Wasserschutz der Bedienseite für die zweipoligen Grundtypen 1832, 1834, 1835 und 1839 mit standard Flanschlänge 30 mm



Blindkappe
203.145.051



Gehäuse
217.132.031

Gehäuse und Blindkappe für einpolige Baugröße 1830, 1831, 1833, 1837 und 1838 aus PA schwarz.

Gehäuse und Kappe werden kundenseitig montiert und sind nur in Kombination sinnvoll



Blindkappe
203.146.051



Gehäuse
217.127.491

Gehäuse und Blindkappe für einpolige Baugröße 1832, 1834, 1835 und 1839 aus PA schwarz.

Gehäuse und Kappe werden kundenseitig montiert und sind nur in Kombination sinnvoll

WIPPSCHALTER

DRUCKSCHALTER

KIPPSCHALTER

SCHIEBESCHALTER

DREHSCHALTER

FLUSSSCHALTER

TASTEN

SCHNAPPSCHALTER

MIKRO-SIGNALSCHALTER

SENSOREN