

SIPMOS® Small-Signal Transistor

- V_{DS} 240 V
- I_D 0.2 A
- $R_{DS(on)}$ 20 Ω
- N channel
- Depletion mode
- High dynamic resistance
- Available grouped in $V_{GS(th)}$

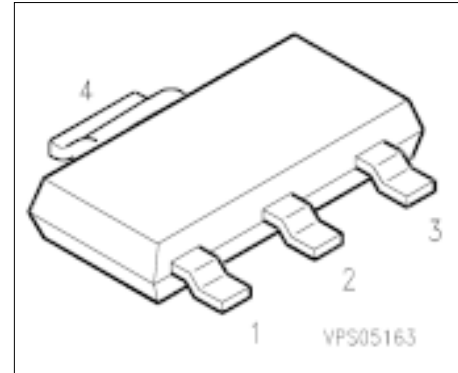

Type	Ordering Code	Tape and Reel Information	Pin Configuration				Marking	Package
			1	2	3	4		
BSP 129	Q67000-S073	E6327: 1000 pcs/reel	G	D	S	D	BSP 129	SOT-223
BSP 129	Q67000-S314	E7941: 1000 pcs/reel $V_{GS(th)}$ selected in groups: (see page 3)						

Maximum Ratings

Parameter	Symbol	Values	Unit	
Drain-source voltage	V_{DS}	240	V	
Drain-gate voltage, $R_{GS} = 20 \text{ k}\Omega$	V_{DGR}	240		
Gate-source voltage	V_{GS}	± 20		
ESD Sensitivity (HBM) as per MIL-STD 883	–	Class 1		
Continuous drain current, $T_A = 34 \text{ }^\circ\text{C}$	I_D	0.2	A	
Pulsed drain current, $T_A = 25 \text{ }^\circ\text{C}$	$I_{D \text{ puls}}$	0.6		
Max. power dissipation, $T_A = 25 \text{ }^\circ\text{C}$	P_{tot}	1.7	W	
Operating and storage temperature range	T_j, T_{stg}	$-55 \dots +150$	$^\circ\text{C}$	
Thermal resistance ¹⁾	chip-ambient	R_{thJA}	72	K/W
	chip-soldering point	R_{thJS}	12	
DIN humidity category, DIN 40 040	–	E	–	
IEC climatic category, DIN IEC 68-1	–	55/150/56		

¹⁾ Transistor on epoxy pcb 40 mm × 40 mm × 1.5 mm with 6 cm² copper area for drain connection.

Electrical Characteristics

at $T_j = 25\text{ }^\circ\text{C}$, unless otherwise specified.

Parameter	Symbol	Values			Unit
		min.	typ.	max.	

Static Characteristics

Drain-source breakdown voltage $V_{GS} = -3\text{ V}$, $I_D = 0.25\text{ mA}$	$V_{(BR)DSS}$	240	–	–	V
Gate threshold voltage $V_{DS} = 3\text{ V}$, $I_D = 1\text{ mA}$	$V_{GS(th)}$	– 1.8	– 1.2	– 0.7	
Drain-source cutoff current $V_{DS} = 240\text{ V}$, $V_{GS} = -3\text{ V}$ $T_j = 25\text{ }^\circ\text{C}$ $T_j = 125\text{ }^\circ\text{C}$	I_{DSS}	– –	– –	100 200	nA μA
Gate-source leakage current $V_{GS} = 20\text{ V}$, $V_{DS} = 0$	I_{GSS}	–	10	100	nA
Drain-source on-resistance $V_{GS} = 0\text{ V}$, $I_D = 0.014\text{ A}$	$R_{DS(on)}$	–	7.0	20	Ω

Dynamic Characteristics

Forward transconductance $V_{DS} \geq 2 \times I_D \times R_{DS(on)max}$, $I_D = 0.25\text{ A}$	g_{fs}	0.14	0.2	–	S
Input capacitance $V_{GS} = 0$, $V_{DS} = 25\text{ V}$, $f = 1\text{ MHz}$	C_{iss}	–	110	150	pF
Output capacitance $V_{GS} = 0$, $V_{DS} = 25\text{ V}$, $f = 1\text{ MHz}$	C_{oss}	–	20	30	
Reverse transfer capacitance $V_{GS} = 0$, $V_{DS} = 25\text{ V}$, $f = 1\text{ MHz}$	C_{rss}	–	7	10	
Turn-on time t_{on} , ($t_{on} = t_{d(on)} + t_r$) $V_{DD} = 30\text{ V}$, $V_{GS} = -2\text{ V} \dots + 5\text{ V}$, $R_{GS} = 50\text{ }\Omega$, $I_D = 0.25\text{ A}$	$t_{d(on)}$	–	4	6	ns
	t_r	–	10	15	
Turn-off time t_{off} , ($t_{off} = t_{d(off)} + t_f$) $V_{DD} = 30\text{ V}$, $V_{GS} = -2\text{ V} \dots + 5\text{ V}$, $R_{GS} = 50\text{ }\Omega$, $I_D = 0.25\text{ A}$	$t_{d(off)}$	–	15	20	
	t_f	–	25	35	

Package Outline

Electrical Characteristics (cont'd)
at $T_j = 25\text{ °C}$, unless otherwise specified.

Parameter	Symbol	Values			Unit
		min.	typ.	max.	
Reverse Diode					
Continuous reverse drain current $T_A = 25\text{ °C}$	I_S	–	–	0.15	A
Pulsed reverse drain current $T_A = 25\text{ °C}$	I_{SM}	–	–	0.45	
Diode forward on-voltage $I_F = 0.3\text{ A}$, $V_{GS} = 0$	V_{SD}	–	0.7	1.4	V

$V_{GS(th)}$ Grouping	Symbol	Limit Values		Unit	Test Condition
		min.	max.		
Range of $V_{GS(th)}$	$\Delta V_{GS(th)}$	–	0.2	V	–
Threshold voltage selected in groups ¹⁾ :	$V_{GS(th)}$				$V_{DS1} = 0.2\text{ V}$; $V_{DS2} = 3\text{ V}$; $I_D = 10\text{ }\mu\text{A}$
F		– 1.600	– 1.400	V	
G		– 1.700	– 1.500	V	
A		– 1.800	– 1.600	V	
B		– 1.900	– 1.700	V	
C		– 2.000	– 1.800	V	
D		– 2.100	– 1.900	V	

1) A specific group cannot be ordered separately.
Each reel only contains transistors from one group.

Characteristics

at $T_j = 25\text{ }^\circ\text{C}$, unless otherwise specified

Total power dissipation $P_{\text{tot}} = f(T_A)$

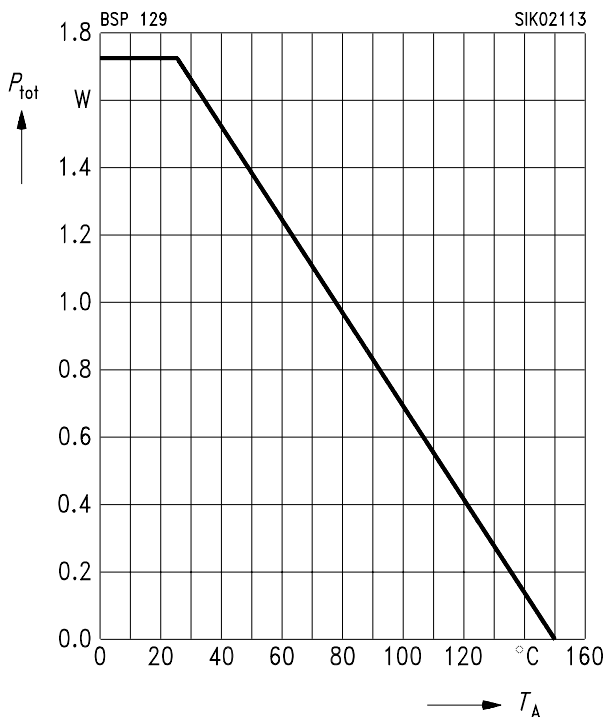

Safe operating area $I_D = f(V_{\text{DS}})$

parameter: $D = 0.01, T_C = 25\text{ }^\circ\text{C}$

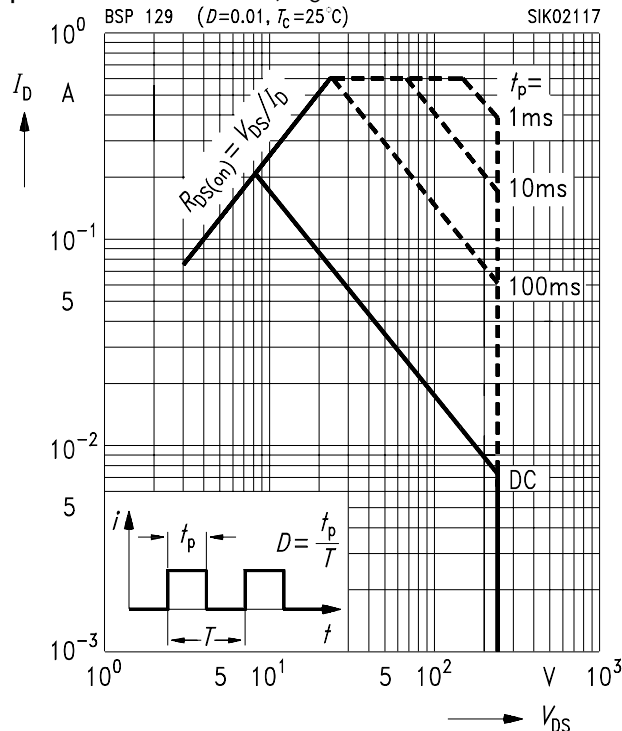

Typ. output characteristics $I_D = f(V_{\text{DS}})$

parameter: $t_p = 80\text{ }\mu\text{s}$

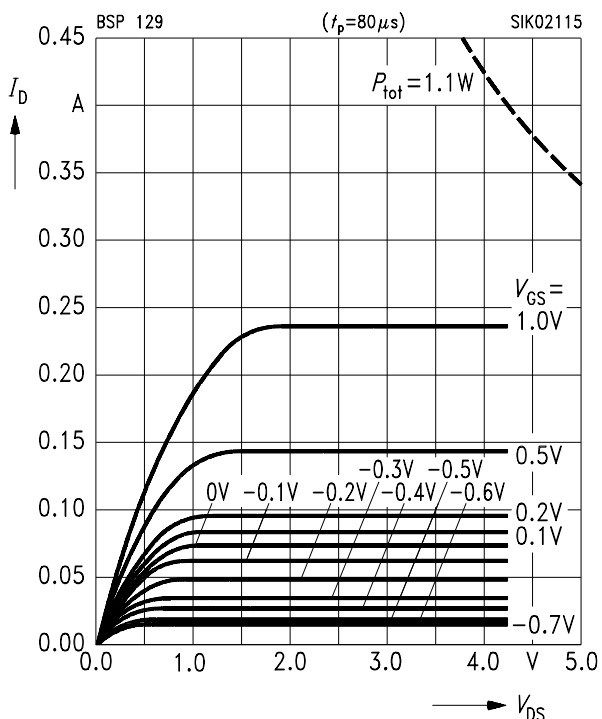

Typ. drain-source on-resistance

$R_{\text{DS(on)}} = f(I_D)$

parameter: V_{GS}

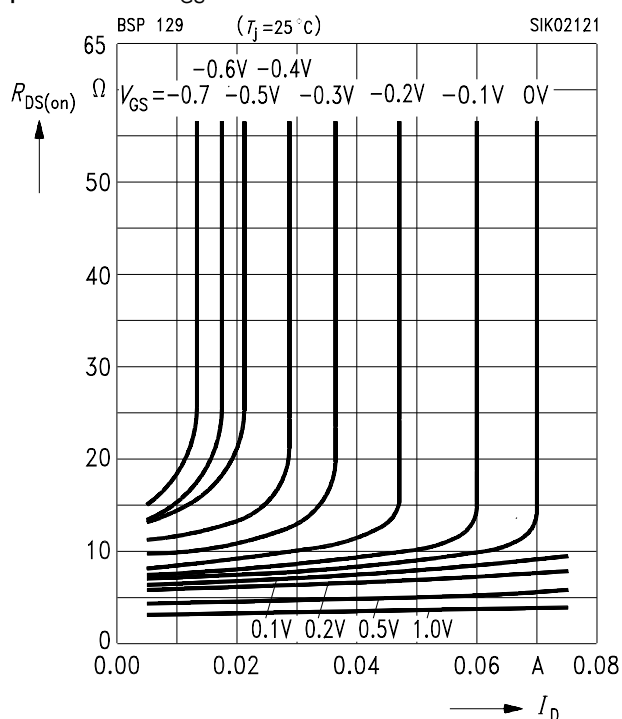

Typ. transfer characteristics $I_D = f(V_{GS})$
 parameter: $t_p = 80 \mu s$, $V_{DS} \geq 2 \times I_D \times R_{DS(on)max.}$

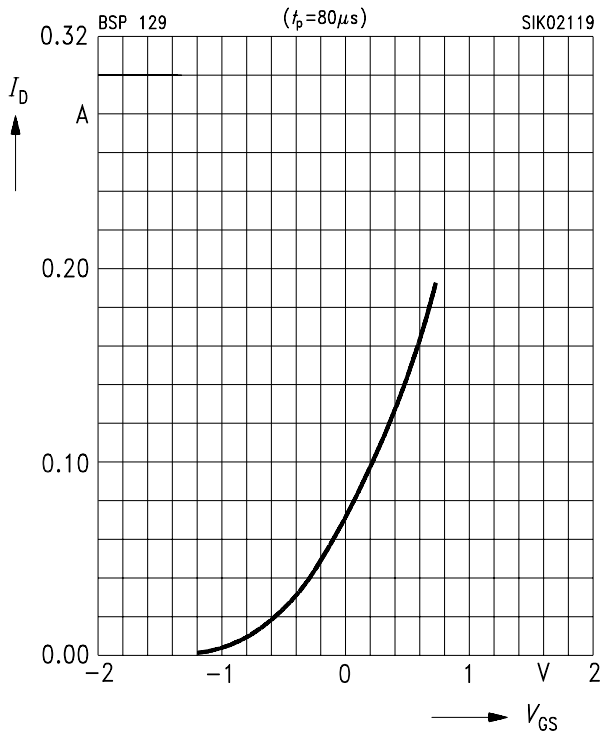

Typ. forward transconductance $g_{fs} = f(I_D)$
 parameter: $V_{DS} \geq 2 \times I_D \times R_{DS(on)max.}$, $t_p = 80 \mu s$

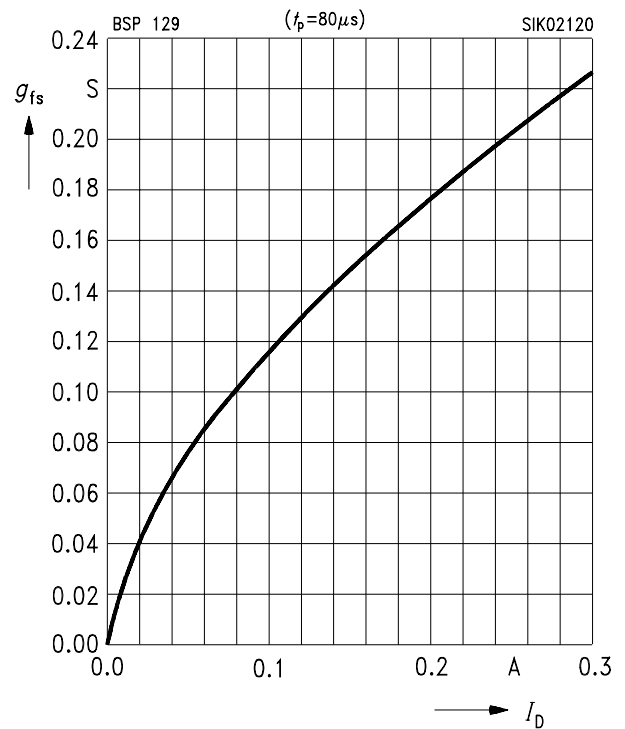

Drain-source on-resistance
 $R_{DS(on)} = f(T_j)$
 parameter: $I_D = 0.014 A$, $V_{GS} = 0 V$, (spread)

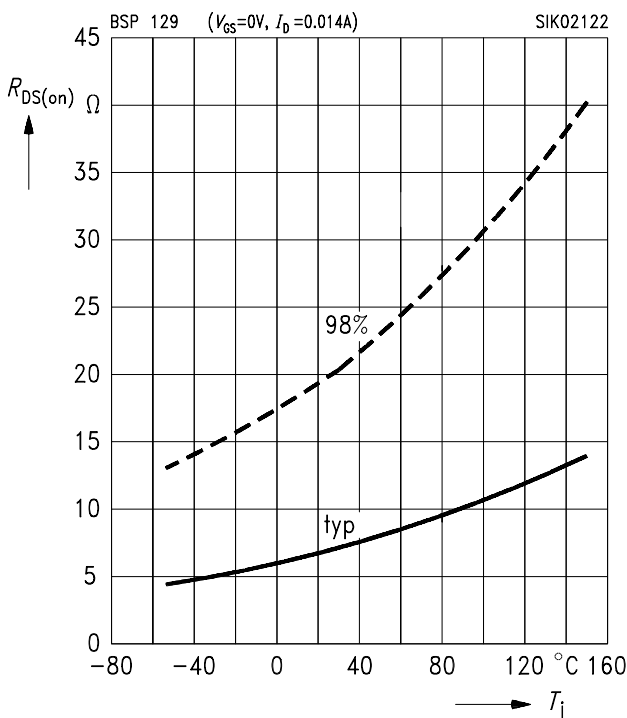

Typ. capacitances $C = f(V_{DS})$
 parameter: $V_{GS} = 0 V$, $f = 1 MHz$

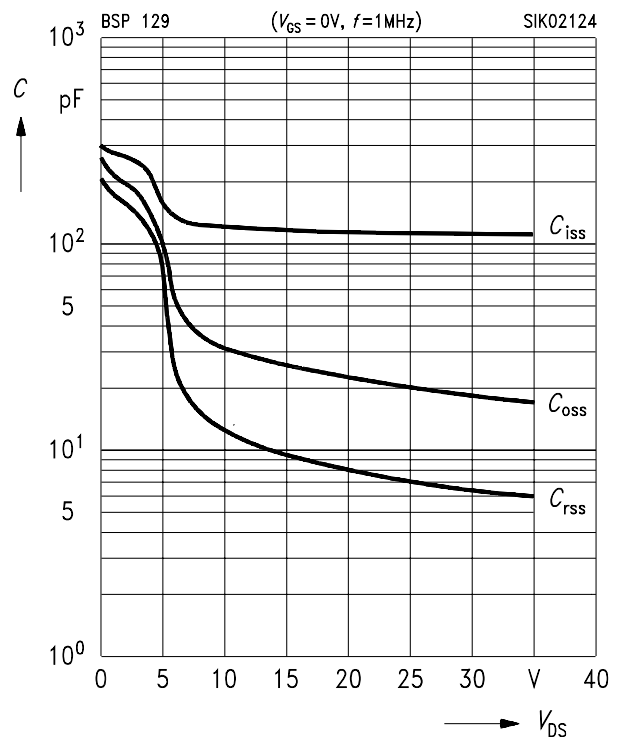

Gate threshold voltage $V_{GS(th)} = f(T_j)$
 parameter: $V_{DS} = 3\text{ V}$, $I_D = 1\text{ mA}$, (spread)

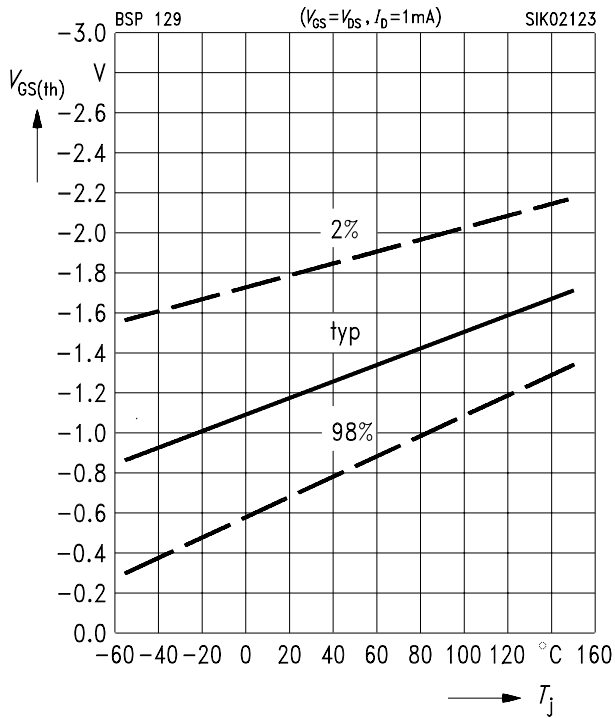

Forward characteristics of reverse diode
 $I_F = f(V_{SD})$
 parameter: $t_p = 80\ \mu\text{s}$, T_j , (spread)

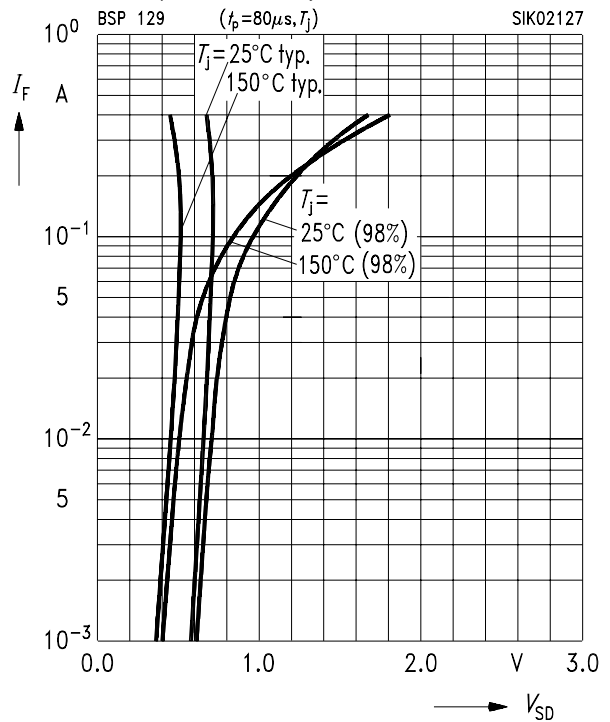

Drain current $I_D = f(T_A)$
 parameter: $V_{GS} \geq 3\text{ V}$

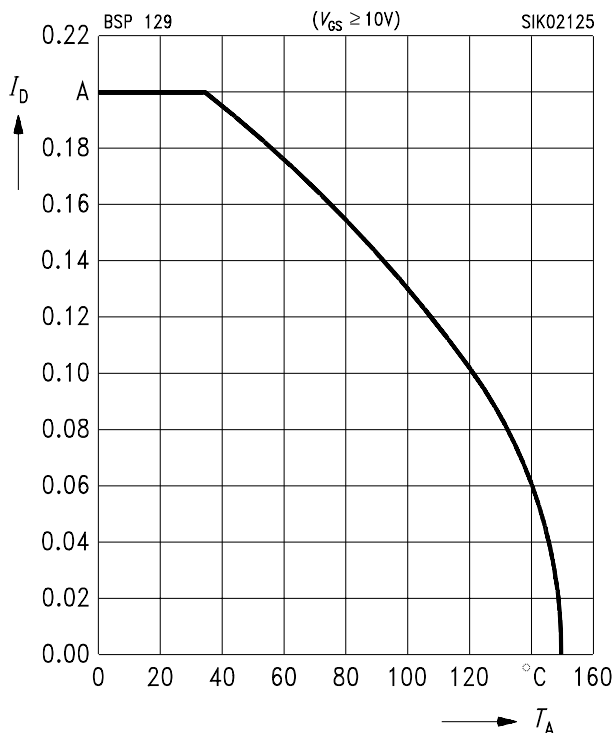

Safe operating area $I_D = f(V_{DS})$
 parameter: $D = 0$, $T_C = 25\text{ °C}$

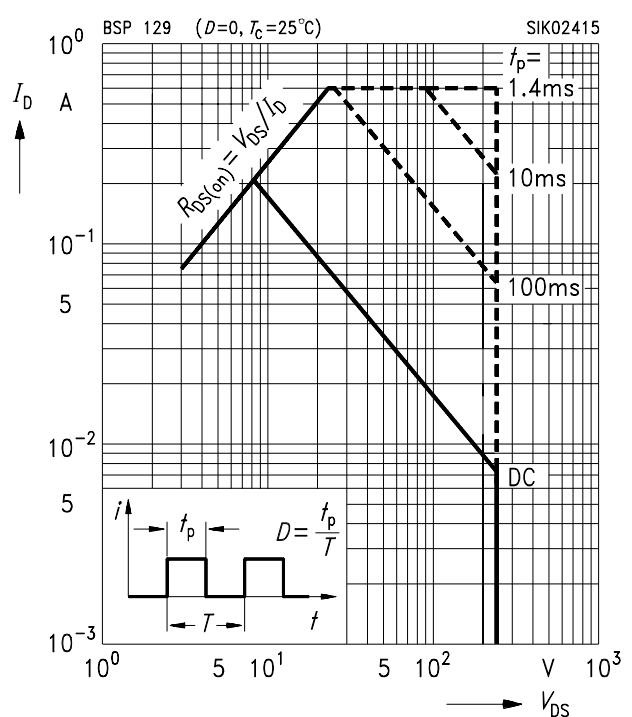

Drain-source breakdown voltage

$$V_{(BR)DSS} = b \times V_{(BR)DSS} (25\text{ }^{\circ}\text{C})$$

