



Part no.: 50131310
CSL505-R05-115-M8
Light curtain receiver



Figure can vary



Contents

- Technical data
- Dimensioned drawings
- Electrical connection
- Operation and display
- Suitable transmitters
- Part number code
- Accessories

Technical data

Basic data	
Series	505
Operating principle	Throughbeam principle
Device type	Receiver
Application	Precise object detection
Optical data	
Operating range	Guaranteed operating range
Operating range	0.3 ... 5 m
Measurement field length	115 mm
Number of beams	24 Piece(s)
Beam spacing	5 mm
Measurement data	
Minimum object diameter	7.5 mm
Electrical data	
Protective circuit	Inductive protection Polarity reversal protection Short circuit protected
Performance data	
Supply voltage U_B	18 ... 30 V , DC
Outputs	
Number of digital switching outputs	2 Piece(s)
Switching outputs	
Switching output 1	
Switching element	Transistor , Push-pull
Switching principle	Light/dark reversible
Switching output 2	
Switching element	Transistor , Push-pull
Switching principle	Light/dark reversible
Timing	
Cycle time	28 ms
Response time per beam	1,000 μ s
Connection	
Number of connections	1 Piece(s)
Connection 1	
Type of connection	Connector
Function	Signal OUT Teach input Voltage supply
Thread size	M8
Type	Male
Material	Metal
No. of pins	4 -pin
Encoding	A-coded

Part no.: 50131310 – CSL505-R05-115-M8 – Light curtain receiver**Mechanical data**

Design	Cubic
Dimension (W x H x L)	12 mm x 200 mm x 58 mm
Housing material	Metal , Aluminum
Lens cover material	Plastic
Housing color	Silver
Type of fastening	Through-hole mounting

Operation and display

Type of display	LED
Number of LEDs	2 Piece(s)
Type of configuration	Software Via pin assignment

Environmental data

Ambient temperature, operation	-30 ... 50 °C
Ambient temperature, storage	-40 ... 65 °C

Certifications

Degree of protection	IP 65
Protection class	III
Standards applied	EN 60947-5-2 (German version)

Classification

Customs tariff number	90314990
eCl@ss 8.0	27270910
eCl@ss 9.0	27270910
ETIM 5.0	EC002549
ETIM 6.0	EC002549

Dimensioned drawings

All dimensions in millimeters

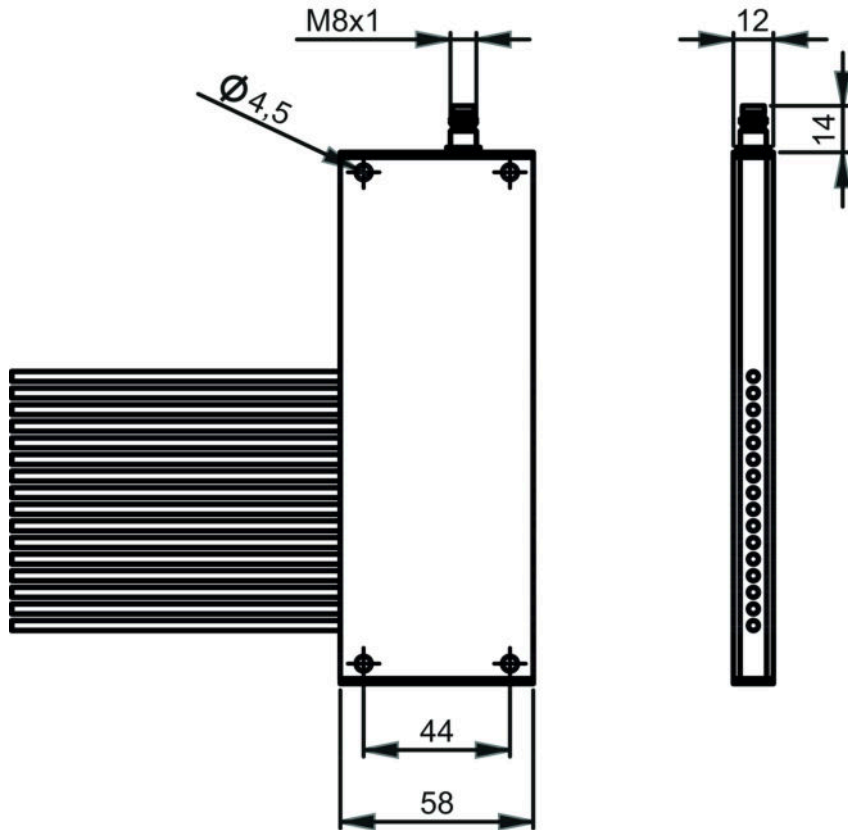

Electrical connection

Connection 1	
Type of connection	Connector
Function	Signal OUT Teach input Voltage supply
Thread size	M8
Type	Male
Material	Metal
No. of pins	4 -pin
Encoding	A-coded

Pin	Pin assignment
1	V+
2	OUT 1 / Teach-in / Warning output
3	GND
4	OUT 2

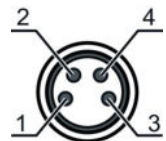

Part no.: 50131310 – CSL505-R05-115-M8 – Light curtain receiver

Operation and display

LEDs

Display LED 1	Display LED 2	Meaning
Off	Off	Off
Red, continuous light	Red, continuous light	Operational readiness
Red, continuous light	Off	Object detected
Red, flashing	Red, continuous light	Ready with minor error
Red, flashing	Off	Object detected with minor error
Red, double flash	Off	Configuration error
Red, flashing in phase	Red, flashing in phase	Serious error A
Red, flashing out of phase	Red, flashing out of phase	Serious error B
Red, continuous light	Red, double flash	Teach event successful

Suitable transmitters

	Part no.	Designation	Article	Description
	50131367	CSL505-T05-115-M8	Light curtain transmitter	Application: Precise object detection Operating range: 0.3 ... 5 m Connection: Connector, M8, 4 -pin

Part number code

Part designation: **CSL505-XXXX-ZZZZ-AA**

X	Operating principle: T: transmitter R: receiver
YYY	Beam spacing: 05: 5 mm 12.5: 12.5 mm 25: 25 mm 50: 50 mm 100: 100 mm
ZZZZ	Measurement field length: Measurement field length [mm], dependent on beam spacing
AA	Electrical connection: M8: M8 connector, 4-pin (plug)



Note

A list with all available device types can be found on the Leuze electronic website at www.leuze.com.

Part no.: 50131310 – CSL505-R05-115-M8 – Light curtain receiver

Accessories

Connection technology - Connection cables

	Part no.	Designation	Article	Description
 	50130850	KD U-M8-4A-V1-050	Connection cable	Connection 1: Connector, M8, Axial, Female, 4 -pin Connection 2: Open end Shielded: No Cable length: 5,000 mm Sheathing material: PVC
 	50130871	KD U-M8-4W-V1-050	Connection cable	Connection 1: Connector, M8, Angled, Female, 4 -pin Connection 2: Open end Shielded: No Cable length: 5,000 mm Sheathing material: PVC

	Part no.	Designation	Article	Description
	50132069	CSL505-Interface	Module	Connection: Sub-D Functions: Configuration and test device

Note

A list with all available accessories can be found on the Leuze electronic website in the Download tab of the article detailed page.