

Product Sheet

Part Number: TMAO 16.32

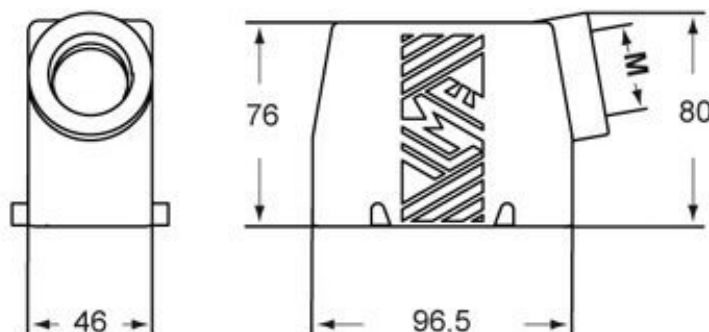

Dimensions in mm



Family	TC - TM insulating enclosures
Version	insulating version
Series	hoods for two levers
Product type	with 4 pegs
Type	side entry
IP degree of protection	IP65 (EN 60529) degree of protection (UL Type 12)
Cable entry	M 32
Fixing centre distance	size "77.27"
Material	insulating
Notes	The enclosures ensure IP protection rating when mated and locked. To be complete with cable glands.

The information and the dimensions are not binding and may be changed without prior notice.