













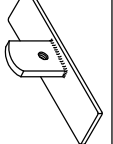

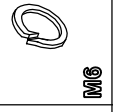
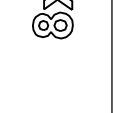

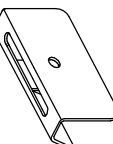
Citroën Jumper 2007 Fiat Ducato 2007 Peugeot Boxer 2007 370x173 cm. L3 H2	 8X	 14 Nm M8x20	 8X	 6 Nm M6x40	 8X
	 8X	 3xD M8	 16X	 M6	 8X
	 8X	 M8	 24X	 3xD M6	 8X
	 8X	 KING ALU	 2X	 8X	 8X

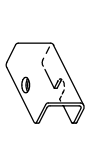

MONTAGEFILM KING-ALU IMPERIAAL

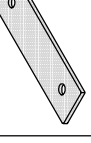
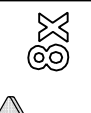

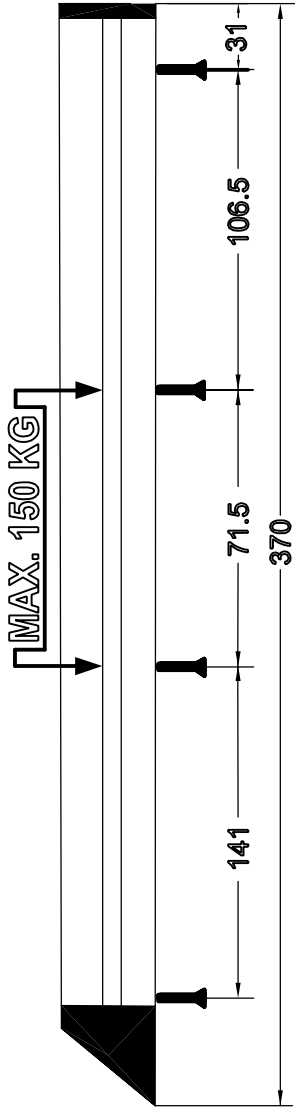
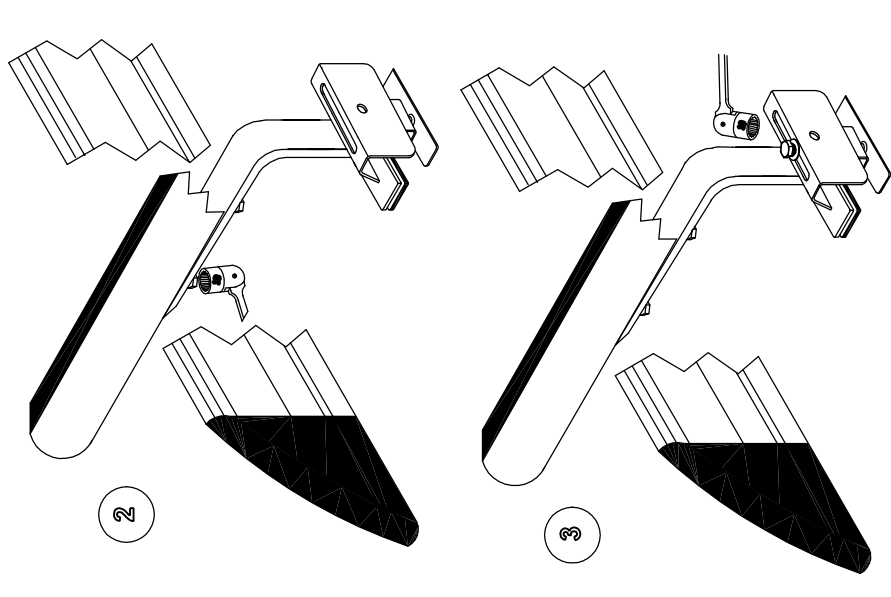
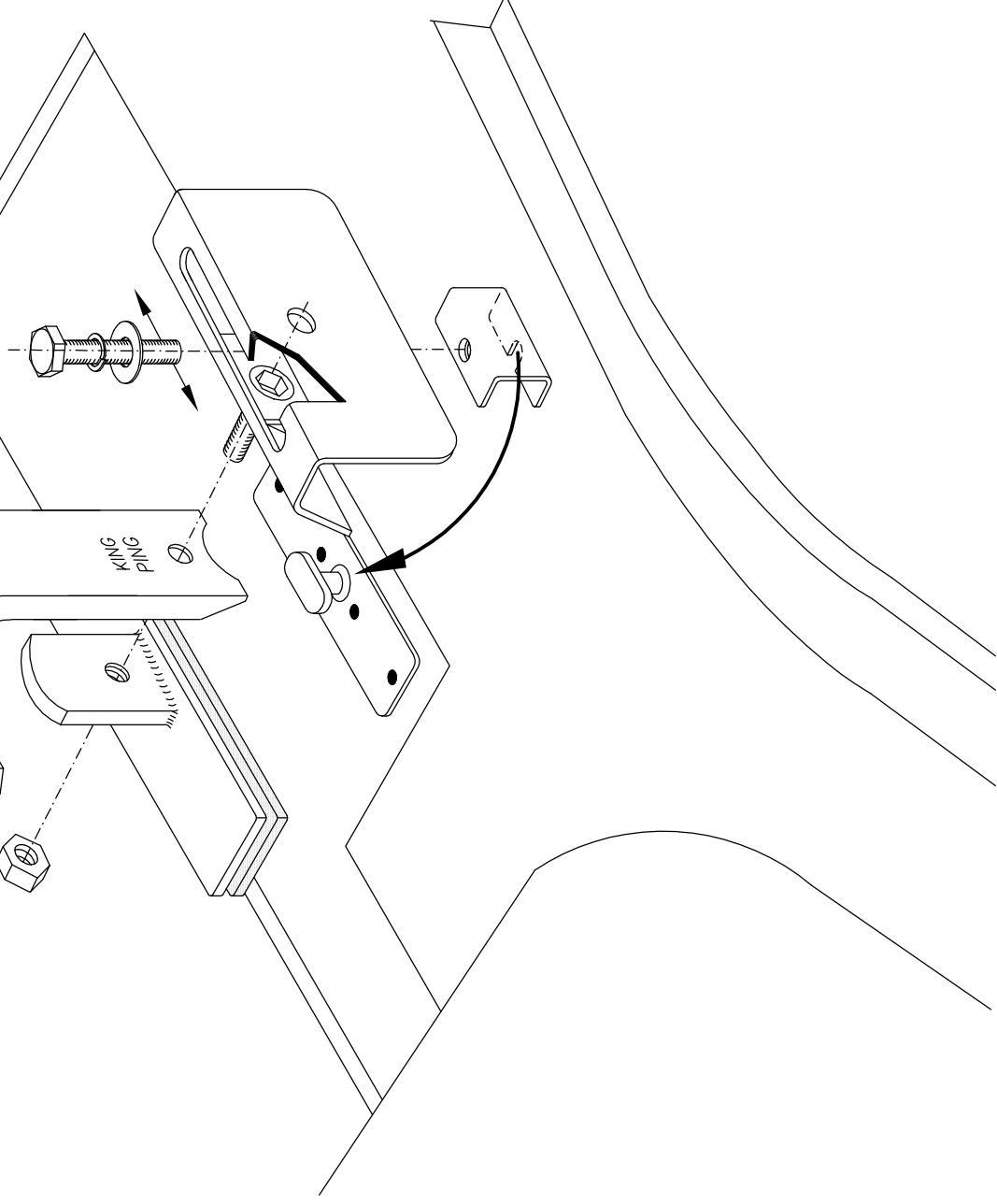
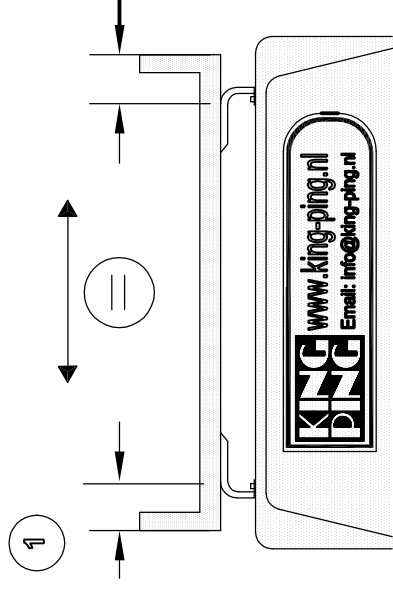
05/2013 ALUCJLH370173S ALUFDLH370173S ALUPBLH370173S