

DIGITAL THREE PHASE ANGLE CONTROLLER

- ▶ Allows to set the voltage applied to different sort of loads with 3 wires, 4 wires or inside the delta wiring:
 - ▶ Resistive (Bulbs, UV and IR lamps, ovens, ...),
 - ▶ Inductive (inductors, transformers, ...),
 - ▶ Motor (motorfan speed control (60 to 100% from the nominal speed),
 - ▶ Rectified (power supplies, ...).
- ▶ Small housing, easy and ready to use.
- ▶ Large mains frequency and voltage range.
- ▶ Fully optoisolated full cycle three phase phase angle controller (balanced currents, less harmonics, ...)
- ▶ Dynamic control voltage range according to the power factor of the load.
- ▶ Softstart and softstop functions (increase lifetime expectancy of the load).
- ▶ Adjustable filter regarding fast input voltage changes (ramps).
- ▶ Motor softstarting functions to control its speed within the stable area.
- ▶ Input-output transfert characteristic linearization function (resistive load).
- ▶ Diagnostic features : Status given on LED and AC/DC switches.

SVTA4684E

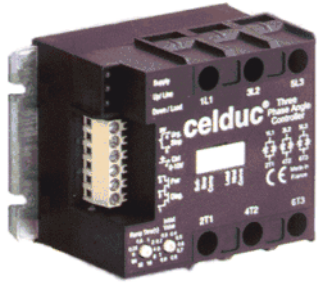

Proportional analog current control input
4-20mA
 200->480VAC
 50A(95A) AC51

Mains Voltage	Mains Frequency	Max AC-51 Current	Max AC-53a Current	Control Input	Status Outputs	In / Out Insulation	Wire Size	Dimensions (WxHxD)	Weight
200 to 480VAC	40 to 65Hz	50A (95A) (with heatsink)	22.5A (with heatsink)	4-20mADC	0 to 24VDC 1A AC/DC	4kV	In=2.5mm ² Out=10mm ²	100x78x56.5 (mm)	500g

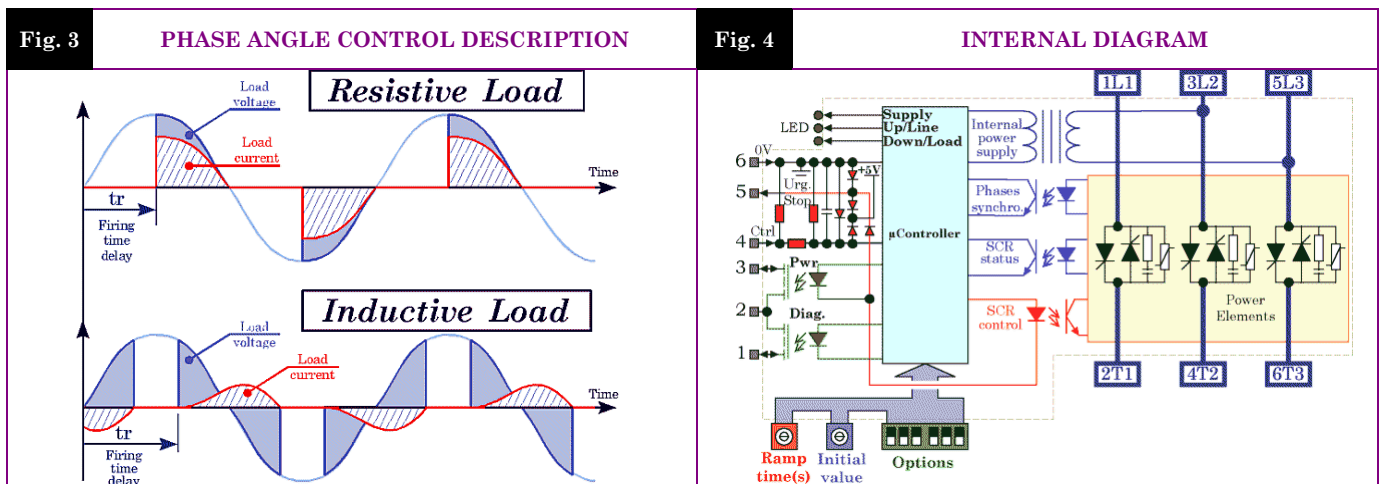
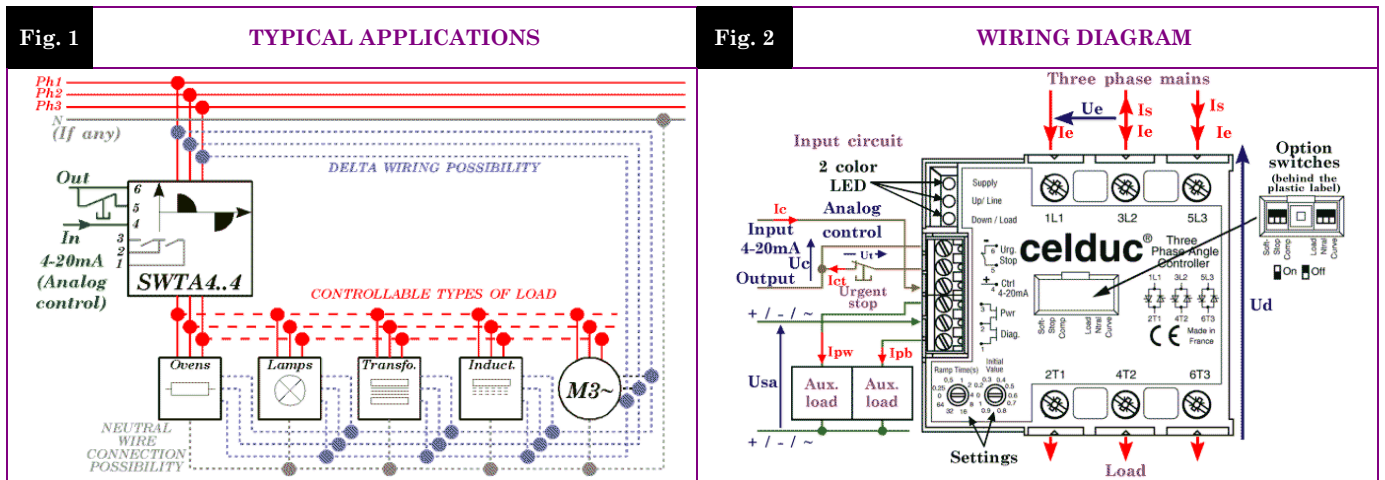

Proud to serve you

celduc[®]

r e l a i s

SETTINGS

SETTINGS AND OPTIONS	Label	“Ramp Time (s)”	“Initial Value”	“Soft Stop”	“Comp”	“Load”	“Ntrl”	“Curve”
	Description							
	Function	Ramp up time (Softstart and smooth transients)	Initial load voltage (footstep)	Ramp down time	Allows to adapt the control signal range whatever the power factor of the load	Ask the unit to make a softstart up to the max. before analog control.	Tells the unit the load star point is connected to the mains neutral	Tells the unit what kind of in-out response to use (angle or RMS voltage linearity)
	Setting possibilities	Ts= 0 to 64s	Vi=0 to 100%	0 x ts =	On (Up)	On (Up)	On (Up)	On (Up)
	White squares = buttons Example :			0,5 x ts =	Inductive load	Motor	Star wiring with neutral (4 wires)	RMS voltage control
= all switches down (OFF) (factory setting)	ts =			Off (Down)	Off (Down)	Off (Down)	Off (Down)	
	2 x ts =			Resistive load	Other loads than motors	Delta or star without neutral	Phase angle control	

INPUT CHARACTERISTICS

INPUT CIRCUIT	CHARACTERISTIC	LABEL	VALUE		INFO.
	Labels			“4-20mA”	“Urg. Stop”
Function			Analog control input	Stop the thyristor controls	
Control type			DC control current	Opening the connection between 5 & 6	
Terminals			4 & 6	5 & 6	
Control current range		Ic	4-20mA	-	
Release and control threshold current		Icsmin	4.5mA	-	
Full power threshold control current		Icsmax	19.5mA	-	
Max. input voltage		Ucmax	12VDC	6VDC	
Max. reverse voltage		-Ucmax	12VDC	6VDC	
Release voltage		Ut		>1,5V	
Input impedance		Re	250Ω	-	See fig. 5
Current to switch		Ict	-	20mADC	Ict=f(Ut)

STATUS OUTPUTS	Labels		“Diag. “	“Pwr”	
	Terminals		1 & 2	2 & 3	
	Function		Indicates a problem detected in the circuit configuration	Indicates the load is supplied	
	Nominal operating voltage	Usan	24VAC/DC		
	Operating voltage range	Usa	0->28VAC/DC		
	Max. peak voltage	Usap	60V		
	Overvoltage protection		Built-in 25V size7 varistors		
	Minimum load current	Ipw/Ipb	0A		
	Maximum load current	Ipw/Ipb	1A AC/DC		See fig. 6
	Maximum overload current	Ipw/Ipb	2.4A AC/DC		@100ms 10% of the cycle
	On and off state switch resistance	Ron / Roff	500mΩ / 100MΩ		See fig. 6
On and off time delay	Ton / Toff	0.5ms / 2ms			

OUTPUT CHARACTERISTICS

CHARACTERISTIC	LABEL	VALUE			INFO.
Mains voltage range	Ue	200 -> 480VAC			
Non-repetitive peak voltage	Uep	1200V			
Oversvoltage protection	VDR	Built-in 510V size 14 varistors			
Maximum nominal currents <i>Nota : Wire cross section limited to 10mm² (50A) by the terminals</i>	Ie	Resistive Ithmax AC51	Motor Iemax AC53a	Motor Ie AC53a	See fig. 7 for limits Values with heatsink Delta wiring : See installation manual
		50A (95A)	22.5A	16A	
Maximum line currents in delta wiring	ILine	87A (165A)	39A	22.5A	
Max motor power	Pe	11kW @400VAC			
Non-repetitive peak overload current (1 cycle of 10ms)	ITSM	1500A			See fig. 8
Melting limit for choosing the protective fuses	I ² t	11000A ² s			@10ms
Minimum load current	Iemin	100mA			
Maximum leakage current	Ielk	7mA			@400VAC 50Hz
Power factor	Pf	0->1			
Mains frequency range	F	40->65Hz			
Max. off-state voltage rise	dv/dt	500V/μs			
Protection against fast voltage transients		Buit-in RC network			
Max. current rise	di/dt	50A/μs			
On-state voltage drop	Ud	1.4V			@Ith
Resistive part of the voltage drop	rt	3.5mΩ			@125°C
Potential part of the voltage drop	Vto	0.9V			@125°C
Maximum junction temperature	Tjmax	125°C			
Junction/case thermal resistance per power element	Rthjc	0.3K/W			Total = 3 power elements
Case heatsink thermal resistance	Rthcs	-			
Built-in heatsink thermal resistance vertically mounted	Rthra	4K/W			@ΔTra=60°C
Heatsink thermal time constant	Tthra	15min			@ΔTra=60°C
Inputs/power outputs insulation voltage	Uimp	4kV			
Input/status outputs insulation voltage	Uied	2.5kV			
Inputs/case insulation voltage	Uimp	4kV			
Status outputs/case insulation voltage	Uimp	4kV			
Isolation resistance	Rio	1GΩ			
Isolation capacitance	Cio	<8pF			
Storage ambient temperature	Tstg	-40->+100°C			
Operating ambient temperature	Tamb	-40->+90°C			See fig. 7
Max. case temperature	Tc	100°C			

POWER CIRCUIT

INTERNAL POWER SUPPLY

INTERNAL POWER SUPPLY	CHARACTERISTIC	LABEL	VALUE	INFO.
	Terminals		3L2 & 5L3	
	Mains voltage range	Ue	200->480VAC	
	Consumption	Is	1mA typical	
	Mains frequency range	F	40-65Hz	
	Turn-on time	tm	100ms	

GENERAL INFORMATION

CONNEC- TIONS	Connections	Power	Input terminal block
	Screwdriver advised	Posidriv 2 or 0.8 x 5.5mm	0.8 x 2mm
	Min and max tightening torque	1.8->3N.m	
	Number and cross section of the wires	2 x 1.5->6mm ² (10mm ² without ferrule)	1 x 2.5mm ²
	Screwdriver for settings	0.8 x 2mm	

MISC.	Housing	UL94V0
	Mounting	Omega DIN rail (DIN50022) or screwed
	Noise level	Low audible vibrations
	Weight	500g

STANDARDS

GENERAL	Standards	EN60947-4-2 & EN60947-4-3
	Protection level	IP2L0
	Protection against direct touch	Accordin to V.D.E. 160 part 100 : Back hand and finger safety
	CE marking	Yes
	UL, cULUS and VDE approvals	Pending

E.M.C. IMMUNITY	TYPE OF TEST	STANDARD	LEVEL	EFFECT
	E.S.D. (Electrostatic discharges)	EN61000-4-2	8kV (air) 4kV (touch)	No effect
	Radiated electromagnetic fields	EN61000-4-3	10V/m	No effect
	Fast transients bursts	EN61000-4-4	2kV direct coupling on the power side 2kV coupling by clamp on the input side	No effect
	Electric chocks	EN61000-4-5	1kV direct coupling differential mode (input and output) 2kV direct coupling common mode (input and output)	No effect
	Voltage drop	EN61000-4-11	-	

E.M.C. EMISSION	Radiated and conducted disturbances	NFEN55011	<p>The conducted or radiated disturbances generated by solid state relays depend on the wiring and load configuration.</p> <p>The test method recommended by the European standards and concerning electromagnetic compatibility leading to results far from reality, we decided to advise our customer in order to adapt their filtering scheme to their application.</p> <p>Please refer to the SVTA – SWTA installation manual.</p>

CHARACTERISTIC CURVES

Fig. 5 CONTROL INPUT CHARACTERISTIC

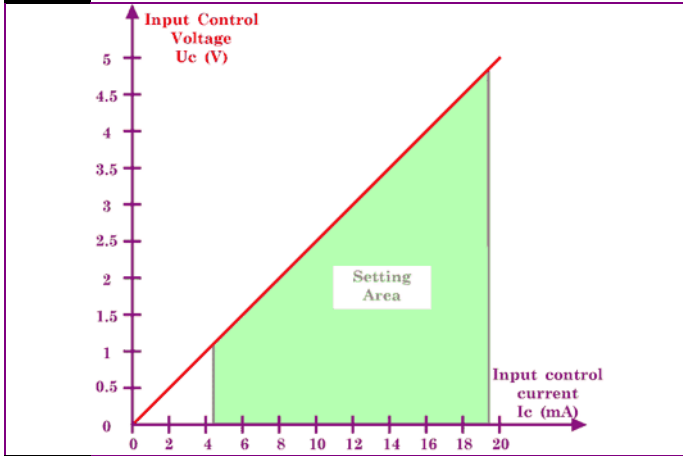

Fig. 6 STATUS SWITCH CURRENT AND ON RESISTANCE VS TEMPERATURE

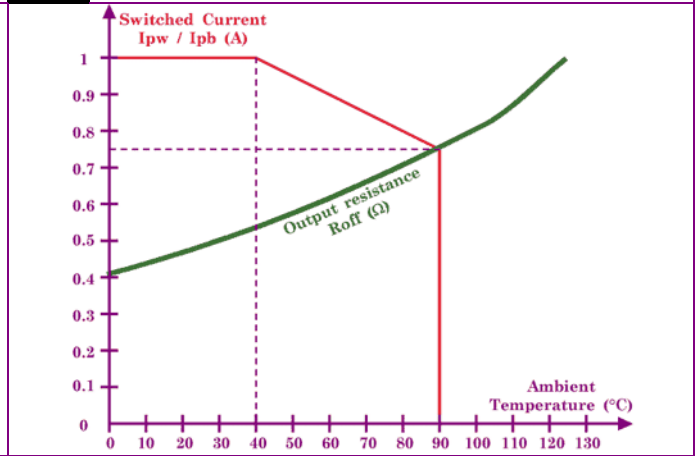

Fig. 7 POWER DISSIPATED AND LOAD CURRENT LIMIT VS TEMPERATURE

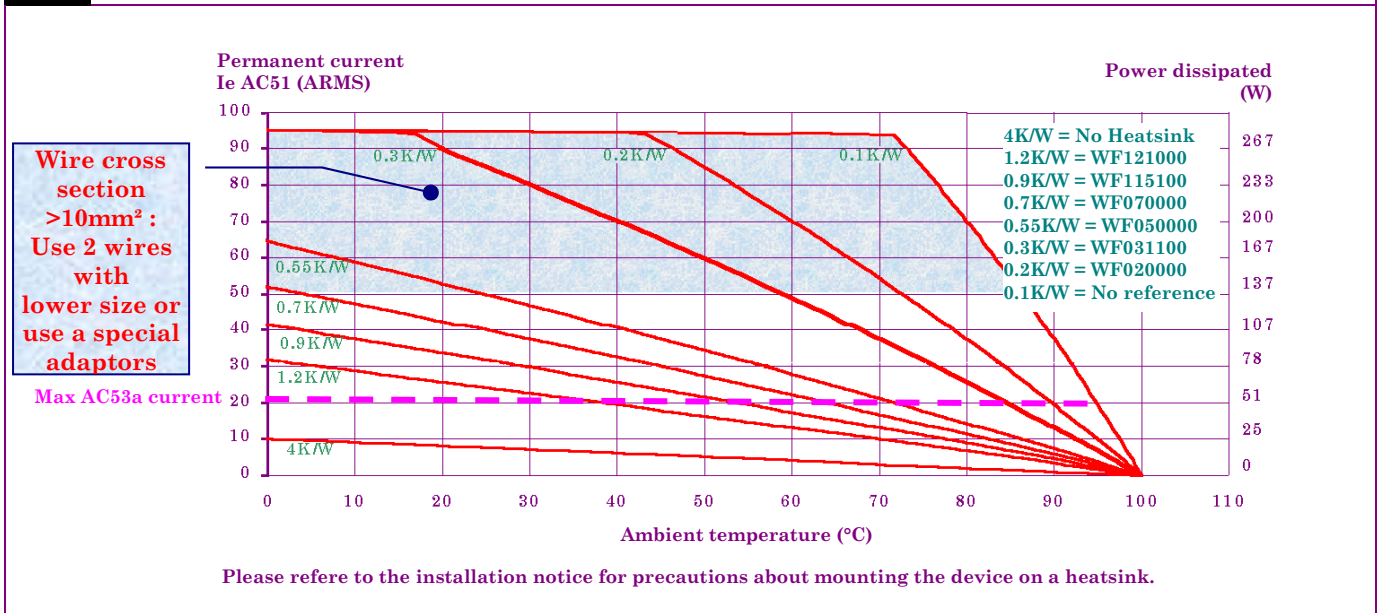
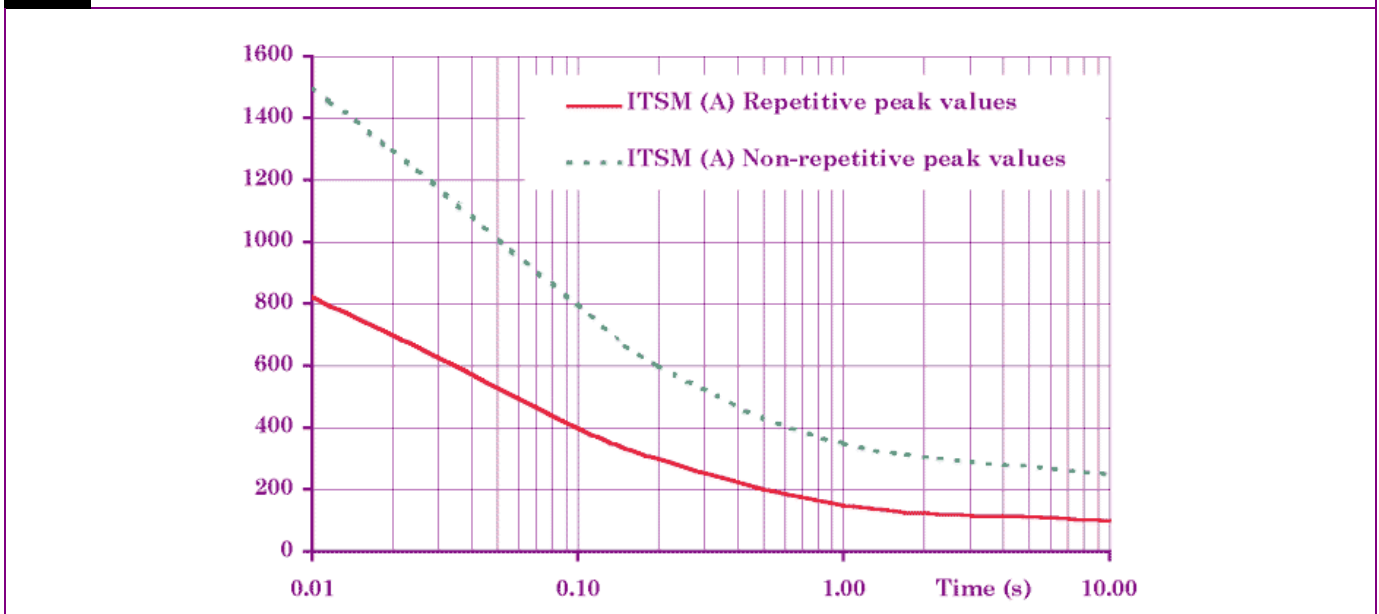

Fig. 8 CURRENT OVERLOAD CHARACTERISTIC (ITSM PER POWER ELEMENT)



DIMENSIONS AND ACCESSORIES

Fig. 9

DIMENSIONS

