

Selection diagram

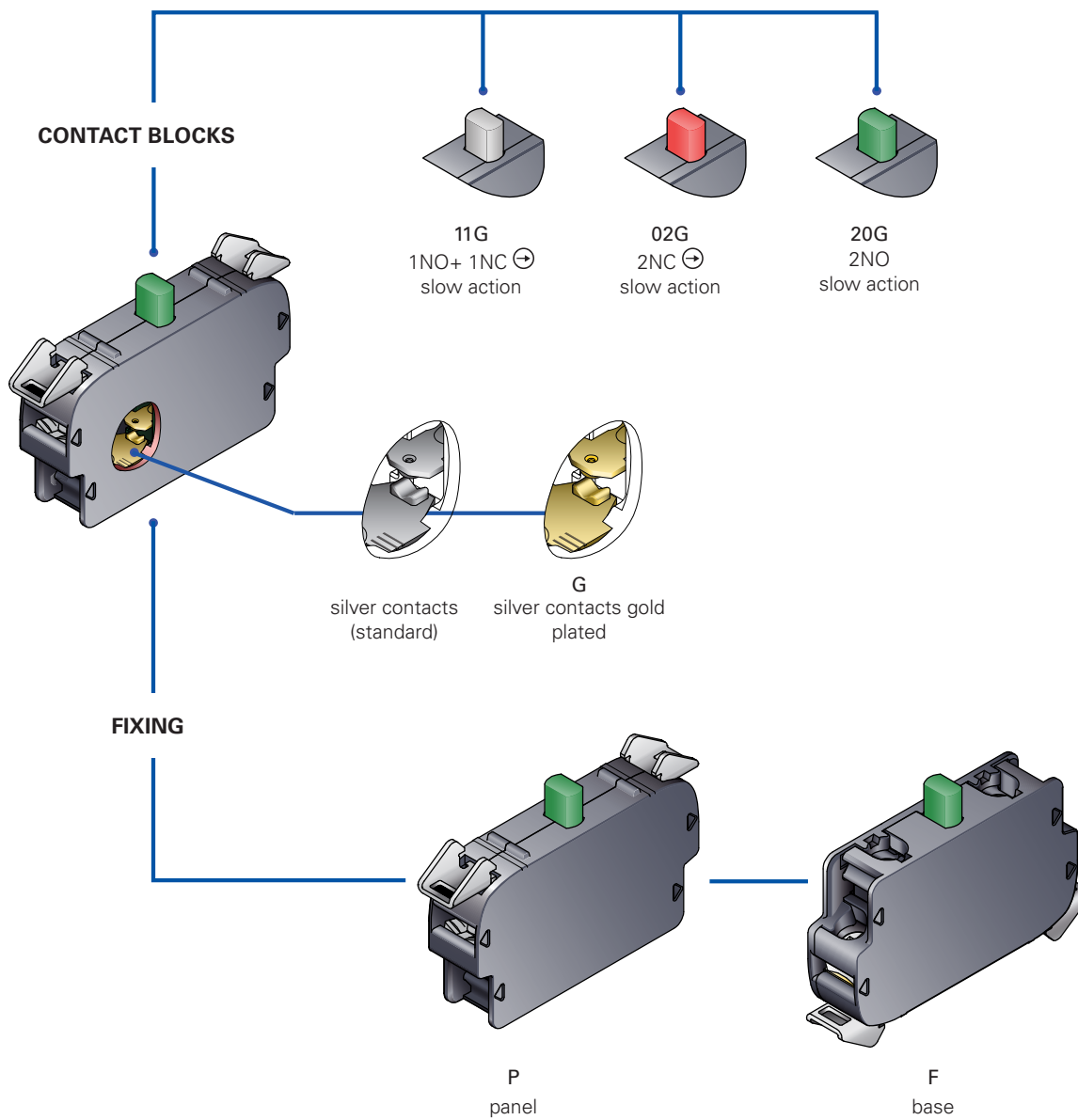

Contact block code structure

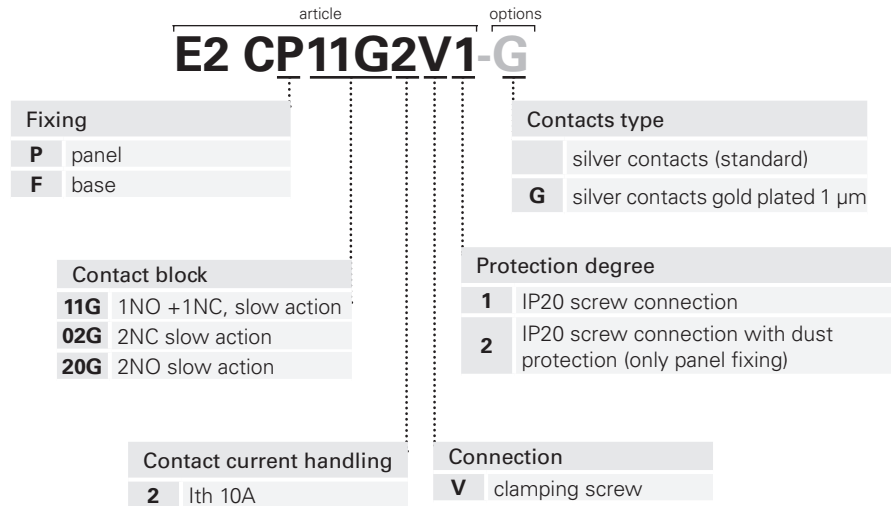

Attention! The feasibility of a code number does not mean the effective availability of a product. Please contact our sales office.

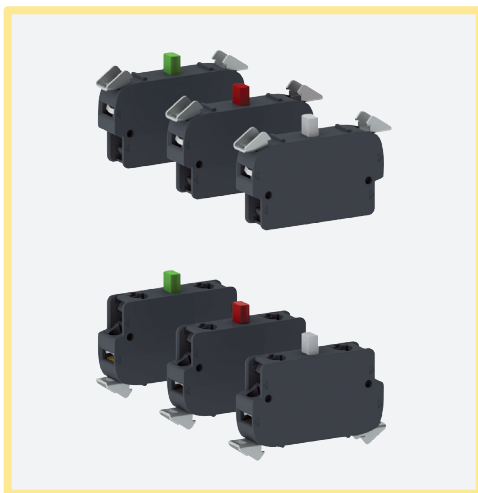

Main features

- High reliability contact blocks with quadruple contact points self-cleaning contacts
- Gold plated contacts version
- Positive opening NC contacts according to IEC 6097-5-1

Markings and quality marks:



Approval GOST: POCC IT.AB24.B04512

Technical data

General data

Protection degree:	IP20 on the terminals according to IEC 60529
Ambient temperature:	-40°C +80°C
Mechanical endurance:	20 million operations cycles
Max operating frequency:	3600 operations cycles/hour
Utilization requirements:	see page 78

Contact block

Contacts commutation force:	2NO: 1,7 N 2NC: 2 N 1NO+1NC: 2,7 N (NO), 2,2 N (NC)
Actuating force at end travel:	2NO: 3,8 N, 2NC: 3,8 N 1NO+1NC: 4,5 N
Positive opening force:	17 N
Activating speed:	min 1 mm/s max 0,5 m/s
Contacts material:	silver contacts (standard) Contacts for weak current in silver, 1µm thick gold-plating (on request) "V shape" self-cleaning contacts with quadruple contact points
Contacts form:	min 1 x 0,34 mm ² (1 x AWG 22) max 2 x 1,5 mm ² (2 x AWG 16)
Conductors cross section:	min 1 x 0,34 mm ² (1 x AWG 22) max 2 x 1,5 mm ² (2 x AWG 16)
Screw terminal driving torque:	0,6 ... 0,8 Nm

In conformity with standards:

IEC 60947-1, IEC 60947-5-1, IEC 60204-1, EN 60947-1, EN 60947-5-1, EN 60204-1, UL 508, CSA 22-2 N°14.

⚠ Installation for safety applications:

Use only switches marked with the symbol ⊕. The safety circuit must always be connected with the **NC contacts** (normally closed contacts: 1-2) as stated in the standard EN 60947-5-1, encl. K, par. 2.

In conformity with requirements requested by:

Low Voltage Directive 2006/95/EC, Machinery Directive 2006/42/EC and Electromagnetic Compatibility 2004/108/EC.

Positive contact opening in conformity with standards:

IEC 60947-5-1, EN 60947-5-1, VDE 0660-206.

Electrical data

Thermal current (I _{th}):	10 A
Rated insulation voltage (U _i):	250 Vac/dc
Protection against short circuits:	fuse 10 A 500 V type gG/gL
Rated impulse withstand voltage (U _{imp}):	4 kV
Pollution degree:	3

Utilization categories

Alternate current: AC15 (50-60 Hz)	
U _e (V)	24 48 120 250
I _e (A)	6 6 6 6
Direct current: DC13	
U _e (V)	24 48 125 250
I _e (A)	2,5 1,3 0,6 0,3

General characteristics

Positive opening

All NC contacts are suitable for safety applications.
NC contacts have positive opening according to IEC 60947-5-1.

High reliability self-cleaning contacts

"V shape" self-cleaning contacts with quadruple contact points. This shape, thanks to its quadruple support, allows to reduce the probability of contact wrong switching. Furthermore it highly improves the contacts reliability in case of dust.

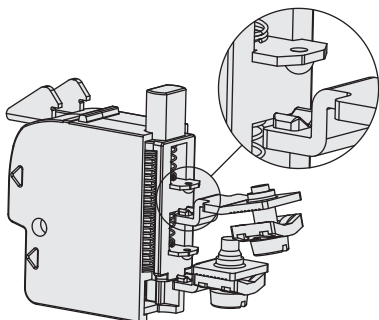





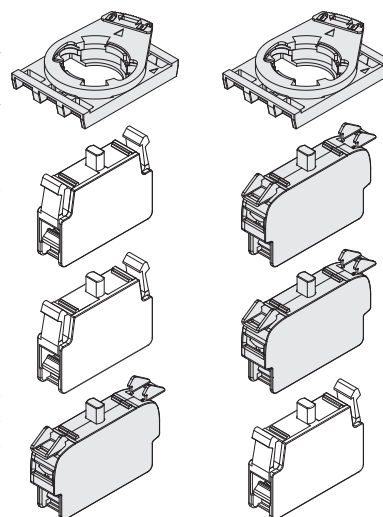

Modularity and compact dimensions

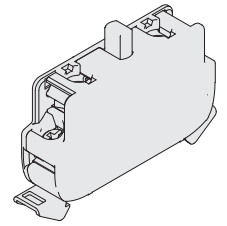
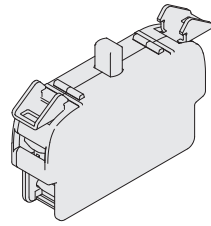

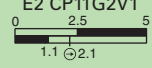

The EROUND double contact blocks are distinguished by their more compact dimensions as compared to the other double contact blocks found on the market. Thanks to their compact dimensions, these versions can also be mounted on the bottom of boxes. However, these double contact blocks have the same vertical overall dimensions of the EROUND single contact blocks: this ensures that single and double contact blocks can be piled up together on several levels, and can be interchanged during the installation stage.

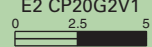

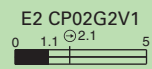
Contact block selection table 5 pcs packs

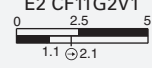



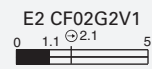

Contact block	Panel fixing Screw connection
1NO+1NC slow action 	E2 CP11G2V1 
2NO slow action 	E2 CP20G2V1 
2NC  slow action	E2 CP02G2V1 

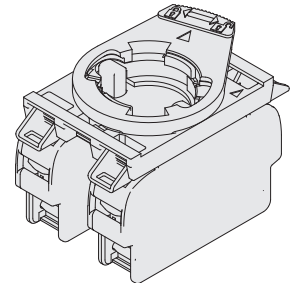
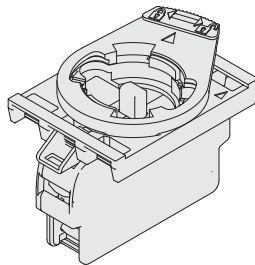
Contact block	Base fixing Screw connection
1NO+1NC slow action 	E2 CF11G2V1 
2NO slow action 	E2 CF20G2V1 
2NC  slow action	E2 CF02G2V1 

Complete units with contact block and fixing adapter



Contacts			Panel fixing Screw connection
pos 2	pos 3	pos 1	
-	1NO+ 1NC 	-	E2 AC-XXBC0135 E2 1BAC11 + E2 CP11G2V1
-	2NO	-	E2 AC-XXBC0136 E2 1BAC11 + E2 CP20G2V1
-	2NC 	-	E2 AC-XXBC0137 E2 1BAC11 + E2 CP02G2V1

Contacts			Panel fixing Screw connection
pos 2	pos 3	pos 1	
1NO+ 1NC 	-	1NO+ 1NC 	E2 AC-XXBC0138 E2 1BAC11 + E2 CP11G2V1+ E2 CP11G2V1

Dimensions

Panel fixing contact block E2 CP••G•••

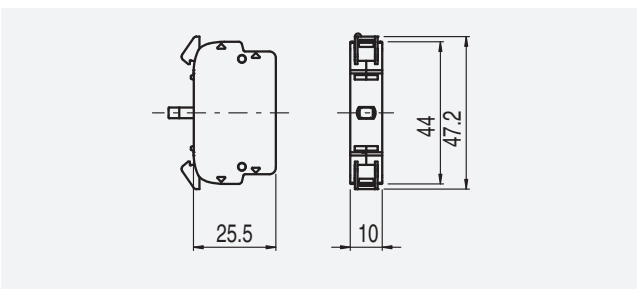

Base fixing contact block E2 CF••G•••

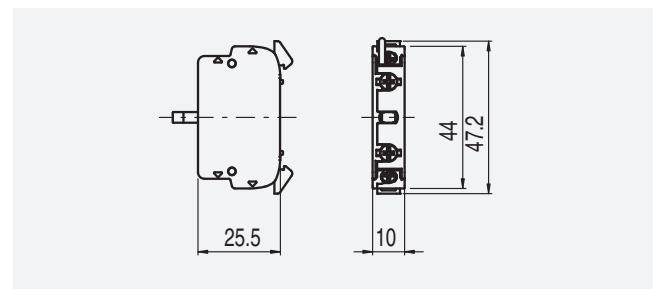

Dust protection 50 pcs packs

Article	Description
VE PR3A70	Transparent dust protection for contact block E2 series. Applicable to all contacts fixed on panels.

Items with code on the **green** background are available in stock