



### ■ Features

- Constant Current mode output with multiple levels selectable by dip switch
- Plastic housing with class II design
- Built-in active PFC function
- Standby power consumption <0.5W
- Functions: DALI interface(logarithm or linear dimming curve selectable), push dimming, synchronization up to 10units
- 3 years warranty

### ■ Applications

- LED indoor lighting
- LED office lighting
- LED architectural lighting
- LED panel lighting

### ■ Description

LCM-25DA series is a 25W AC/DC constant current mode output LED driver featuring the multiple levels selectable by dip switch and the DALI interface with the compliance to IEC62386-207. LCM-25DA operates from 180~277VAC and offers different current levels ranging between 350mA and 1050mA. Thanks to the efficiency up to 86%, with the fanless design, the entire series is able to operate for -30°C~+85°C case temperature under free air convection. In addition, LCM-25DA is equipped with push dimming and synchronization so as to provide the optimal design flexibility for LED lighting system.

### ■ Model Encoding

**LCM - 25DA**

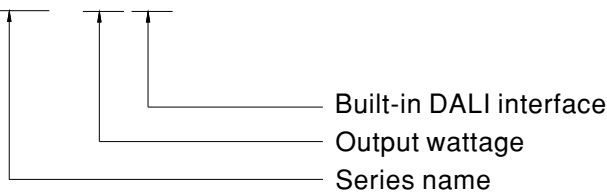



## SPECIFICATION

MODEL		LCM-25DA					
OUTPUT	CURRENT LEVEL	Current level selectable via DIP switch, please refer to "DIP SWITCH TABLE" section					
		350mA	500mA	600mA	700mA(default)	900mA	1050mA
	RATED POWER	18.9W	25.2W				
	DC VOLTAGE RANGE	6 ~ 54V	6 ~ 50V	6 ~ 42V	6 ~ 36V	6 ~ 28V	6 ~ 24V
	OPEN CIRCUIT VOLTAGE (max.)	59V			41V		
	CURRENT RIPPLE	5.0% max. @rated current					
	CURRENT TOLERANCE	±5%					
	SETUP TIME Note.3	500ms / 230VAC					
INPUT	VOLTAGE RANGE Note.2	180 ~ 277VAC 254 ~ 392VDC (Please refer to "STATIC CHARACTERISTIC" section)					
	FREQUENCY RANGE	47 ~ 63Hz					
	POWER FACTOR (Typ.)	PF ≥ 0.94/230VAC, PF ≥ 0.91/277VAC@full load (Please refer to "POWER FACTOR (PF) CHARACTERISTIC" section)					
	TOTAL HARMONIC DISTORTION	THD < 20% (@load ≥ 50%/230VAC; @load ≥ 75%/277VAC) (Please refer to "TOTAL HARMONIC DISTORTION (THD)" section)					
	EFFICIENCY (Typ.) Note.4	86%					
	AC CURRENT (Typ.)	0.17A/230VAC 0.15A/277VAC					
	INRUSH CURRENT (Typ.)	COLD START 20A (t <sub>width</sub> =260μs measured at 50% I <sub>peak</sub> ) at 230VAC; Per NEMA 410					
	MAX. No. of PSUs on 16A CIRCUIT BREAKER	26 units (circuit breaker of type B) / 44 units (circuit breaker of type C) at 230VAC					
	LEAKAGE CURRENT	<0.5mA / 240VAC					
STANDBY POWER CONSUMPTION Note.5	<0.5W						
PROTECTION	SHORT CIRCUIT	Constant current limiting, recovers automatically after fault condition is removed					
	OVER TEMPERATURE	Shut down o/p voltage, recovers automatically after temperature goes down					
FUNCTION	DIMMING	Please refer to "DIMMING OPERATION" section					
	SYNCHRONIZATION	Please refer to "SYNCHRONIZATION OPERATION" section					
ENVIRONMENT	WORKING TEMP.	T <sub>case</sub> =-30 ~ +85°C (Please refer to "OUTPUT LOAD vs TEMPERATURE" section)					
	MAX. CASE TEMP.	T <sub>case</sub> =+85°C					
	WORKING HUMIDITY	20 ~ 90% RH non-condensing					
	STORAGE TEMP., HUMIDITY	-40 ~ +80°C, 10 ~ 95% RH					
	TEMP. COEFFICIENT	±0.03%/°C (0 ~ 50°C)					
	VIBRATION	10 ~ 500Hz, 2G 10min./1cycle, period for 60min. each along X, Y, Z axes					
SAFETY & EMC	SAFETY STANDARDS	UL8750, CSA C22.2 NO.250.0-08, ENEC EN61347-1, EN61347-2-13, EN62384 independent, GB19510.14, GB19510.1 approved					
	DALI STANDARDS	Comply with IEC62386-101, 102, 207					
	WITHSTAND VOLTAGE	I/P-O/P: 3.75KVAC; I/P-DA ±: 1.875KVAC; O/P-DA ±: 1.875KVAC					
	ISOLATION RESISTANCE	I/P-O/P: >100M Ohms / 500VDC / 25°C / 70% RH					
	EMC EMISSION Note.6	Compliance to EN55015, EN61000-3-2 Class C (@load ≥ 50%); EN61000-3-3; GB17625.1, GB17743					
EMC IMMUNITY	Compliance to EN61000-4-2, 3, 4, 5, 6, 8, 11, EN61547, light industry level (surge immunity Line-Line 2KV)						
OTHERS	MTBF	213.3K hrs min. MIL-HDBK-217F (25°C)					
	DIMENSION	105*68*23mm (L*W*H)					
	PACKING	0.17Kg; 72pcs/13.2Kg/1.04CUFT					
NOTE	<ol style="list-style-type: none"> <li>All parameters NOT specially mentioned are measured at 230VAC input, rated current and 25°C of ambient temperature.</li> <li>De-rating may be needed under low input voltages. Please refer to "STATIC CHARACTERISTIC" sections for details.</li> <li>Length of set up time is measured at first cold start. Turning ON/OFF the driver may lead to increase of the set up time.</li> <li>Efficiency is measured at 500mA/50V output set by DIP switch.</li> <li>Standby power consumption is measured at 230VAC.</li> <li>The driver is considered as a component that will be operated in combination with final equipment. Since EMC performance will be affected by the complete installation, the final equipment manufacturers must re-qualify EMC Directive on the complete installation again.</li> </ol>						

**■ BLOCK DIAGRAM**

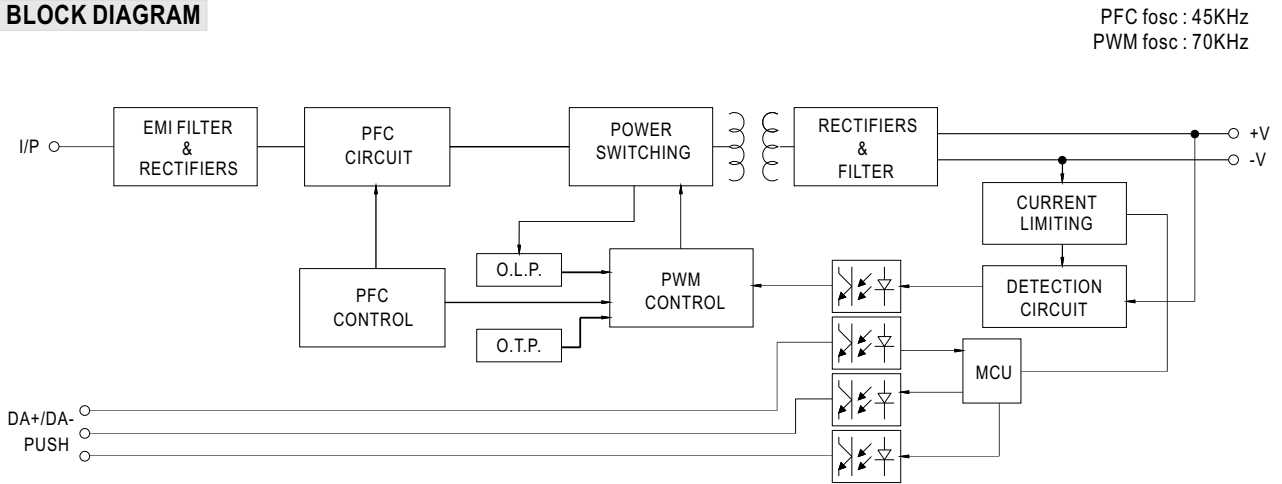

**■ DIP SWITCH TABLE**

LCM-25DA is a multiple-stage constant current driver, selection of output current through DIP switch is exhibited below.

Io \ DIP S.W.	1	2	3	4	5	6
350mA	----	----	----	----	----	----
500mA	ON	----	----	----	----	----
600mA	ON	ON	----	----	----	----
700mA(factory default)	ON	ON	ON	----	----	ON
900mA	ON	ON	ON	ON	----	ON
1050mA	ON	ON	ON	ON	ON	ON

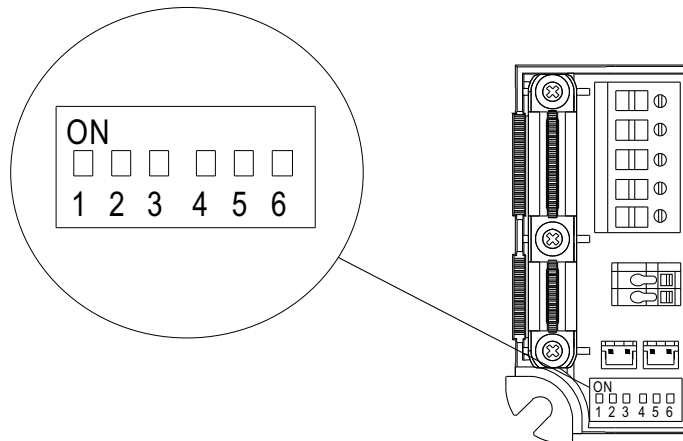

**■ DIMMING OPERATION**

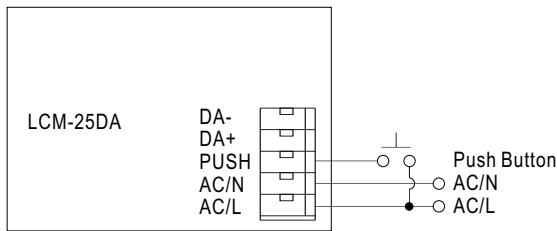

※ **PUSH dimming(primary side)**

Action	Action duration	Function
Short push	0.1~1 sec.	Turn ON-OFF the driver
Long push	1.5~10 sec.	Every Long Push changes the dimming direction, dimming up or down
Reset	>11 sec.	Set up the dimming level to 100%

- The factory default dimming level is at 100%.
- If the push action lasts less than 0.05 sec., it will not lead to a change for the status of the driver.
- Up to 10 drivers can perform the PUSH dimming at the same time when utilizing one common push button.
- The maximum length of the cable from the push button to the last driver is 20 meters.
- The additive push button can be connected only between the PUSH terminal, as displayed in the diagram, and AC/L (in brown or black); it will lead to short circuit if it is connected to AC/N.

※ **DALI interface(primary side)**

- Apply DALI signal between DA+ and DA-
- DALI protocol comprises 16 groups and 64 addresses.
- First step is fixed at 6% of output.

**■ SYNCHRONIZATION OPERATION**

- Synchronization up to 10 drivers (1 master + 9 slaves)
  - Maximum cable length between each unit : 20 meter.
  - Maximum cable length from the master unit to each end of the last slave units : 120 meters.
  - The lighting units driven by LCM units(Slaves) can be dimmed synchronously through a LCM unit(the master) directly controlled via DALI or push dim dimming function.
- The wiring is shown as follows.

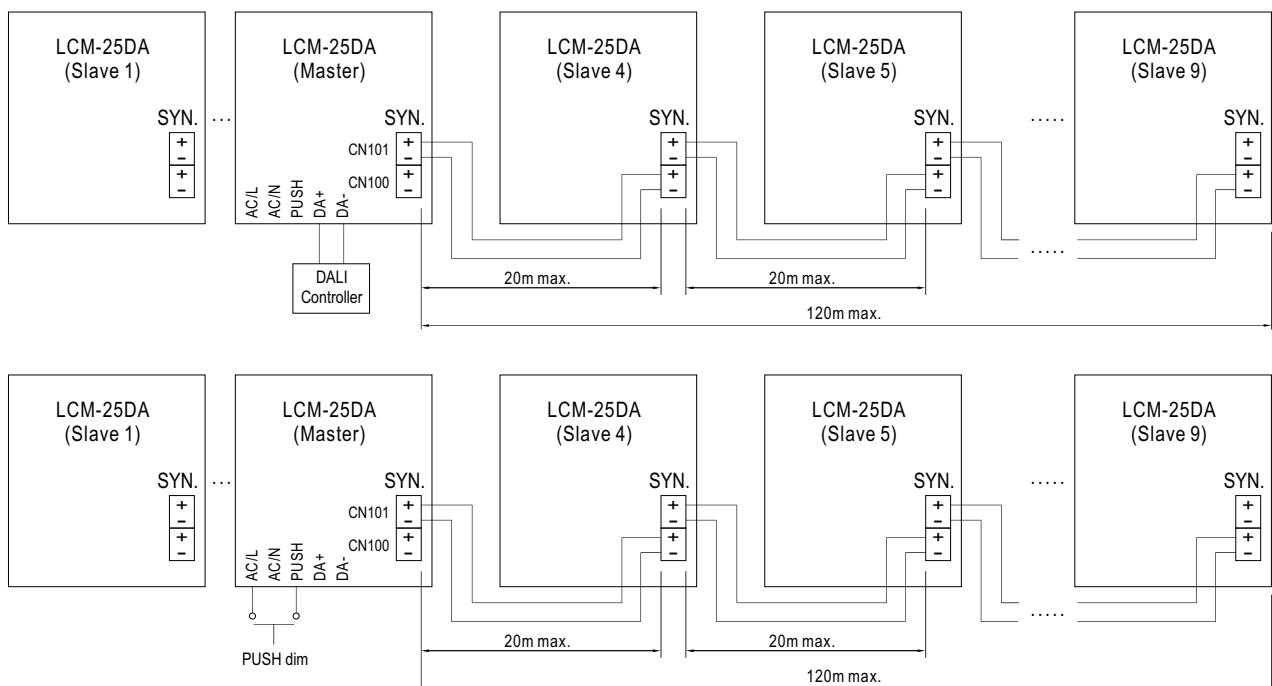

- CN100, CN101 : used to synchronously control the LCM units in parallel.
- ※ Please make sure all units are set to 100% dimming setting (factory default) before synchronization.

■ **OUTPUT LOAD vs TEMPERATURE**

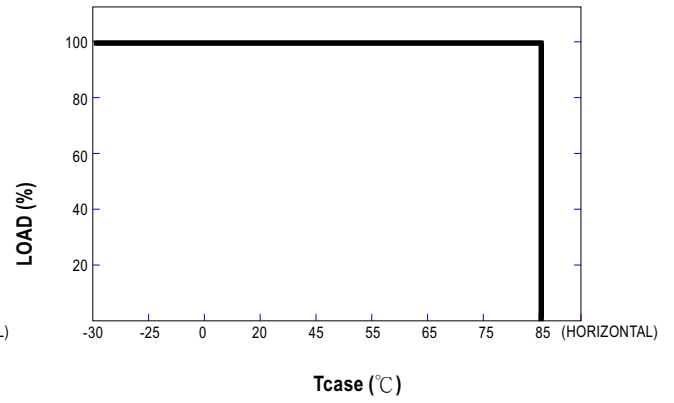
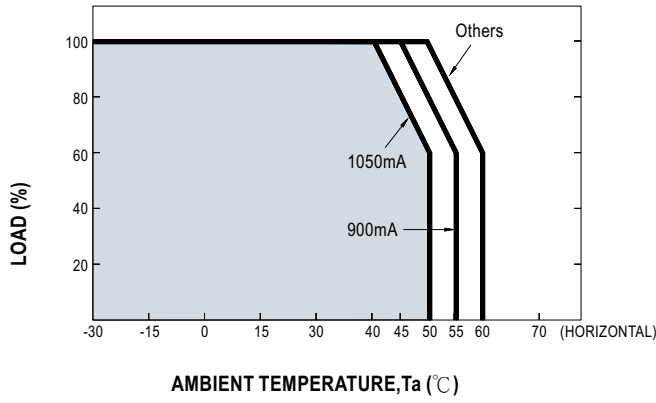

■ **STATIC CHARACTERISTIC**

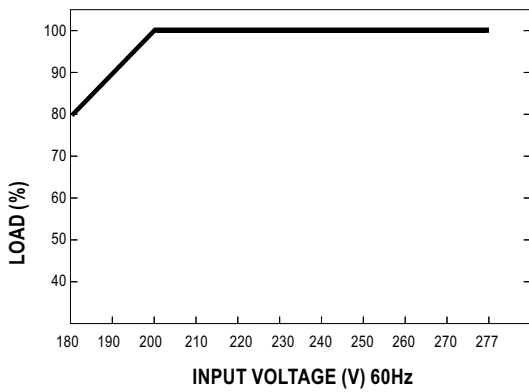

※ De-rating is needed under low input voltage.

**TOTAL HARMONIC DISTORTION (THD)**

※ Tcase at 75°C

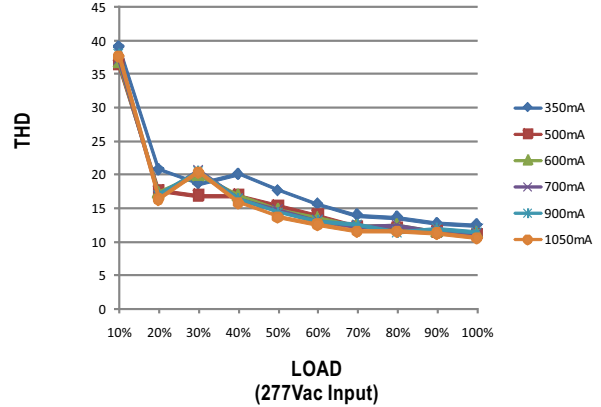
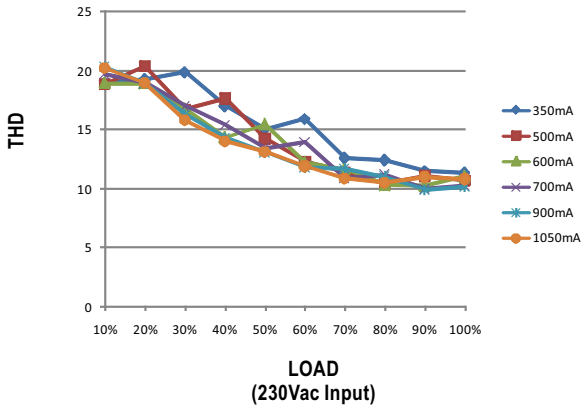

**POWER FACTOR (PF) CHARACTERISTIC**

※ Tcase at 75°C

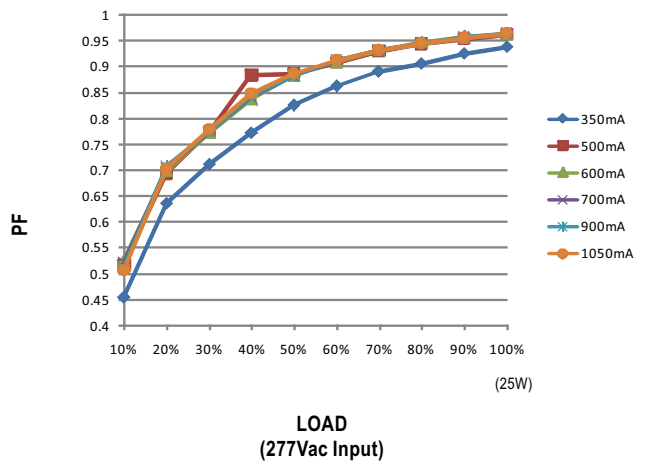
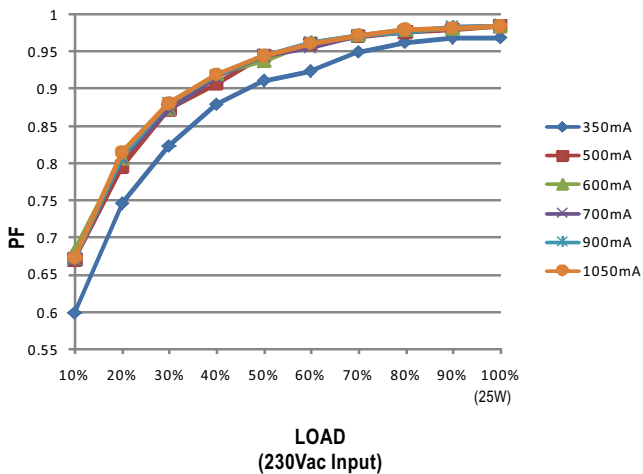

**EFFICIENCY vs LOAD**

LCM-25DA series possess superior working efficiency that up to 86% can be reached in field applications.

※ Tcase at 75°C

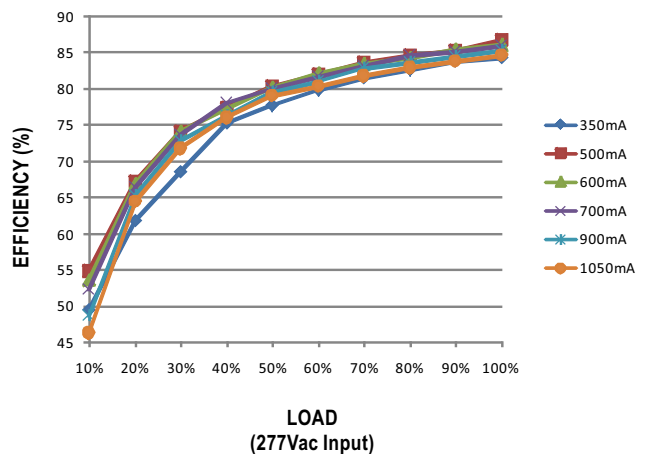
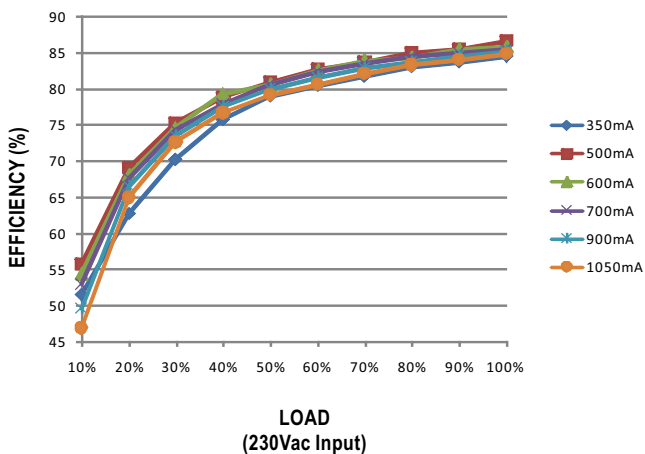

**MECHANICAL SPECIFICATION**

Case No.LCM-25 Unit:mm

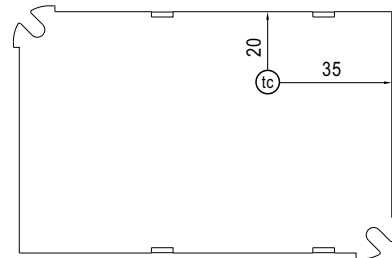
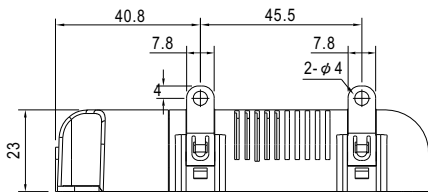
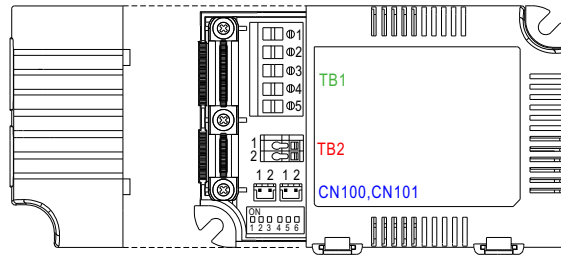
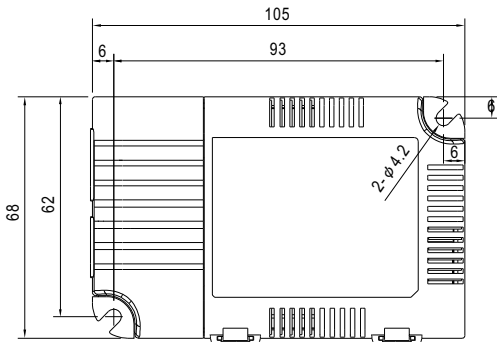

Bottom View

• (tc) : Max. Case Temperature

※ Terminal Pin No. Assignment(TB1)

Pin No.	Assignment	Pin No.	Assignment
1	AC/L	4	DA+
2	AC/N	5	DA-
3	PUSH		

※ Terminal Pin No. Assignment(TB2)

Pin No.	Assignment
1	+V
2	-V

※ SYN. Connector(CN100/CN101):JST B2B-PH-KL or equivalent

Pin No.	Assignment	Mating Housing	Terminal
1	-	JST PHR-2 or equivalent	JST SPH-002T-P0.5S or equivalent
2	+		

Note:Please use wires with a cross section of 0.5~2.5mm<sup>2</sup>(14~20AWG) for TB1 and wires with a cross section of 0.5~1.5 mm<sup>2</sup>(16~20AWG) for TB2. Please use wires with a cross section of 0.126~0.205mm<sup>2</sup>(24~26AWG) for CN100/CN101

**INSTALLATION MANUAL**

Please refer to : <http://www.meanwell.com/webnet/search/InstallationSearch.html>