

Introduction

The STM32 Nucleo board (NUCLEO-F030R8, NUCLEO-F072RB, NUCLEO-F103RB, NUCLEO-F302R8, NUCLEO-F334R8, NUCLEO-F401RE, NUCLEO-F411RE, NUCLEO-L053R8, NUCLEO-L152RE) provides an affordable and flexible way for users to try out new ideas and build prototypes with any STM32 microcontroller lines, choosing from the various combinations of performance, power consumption and features. The Arduino™ connectivity support and ST Morpho headers make it easy to expand the functionality of the Nucleo open development platform with a wide choice of specialized shields. The STM32 Nucleo board does not require any separate probe as it integrates the ST-LINK/V2-1 debugger/programmer. The STM32 Nucleo board comes with the STM32 comprehensive software HAL library together with various packaged software examples, as well as direct access to mbed online resources at mbed.org.

Figure 1. STM32 Nucleo board (1)

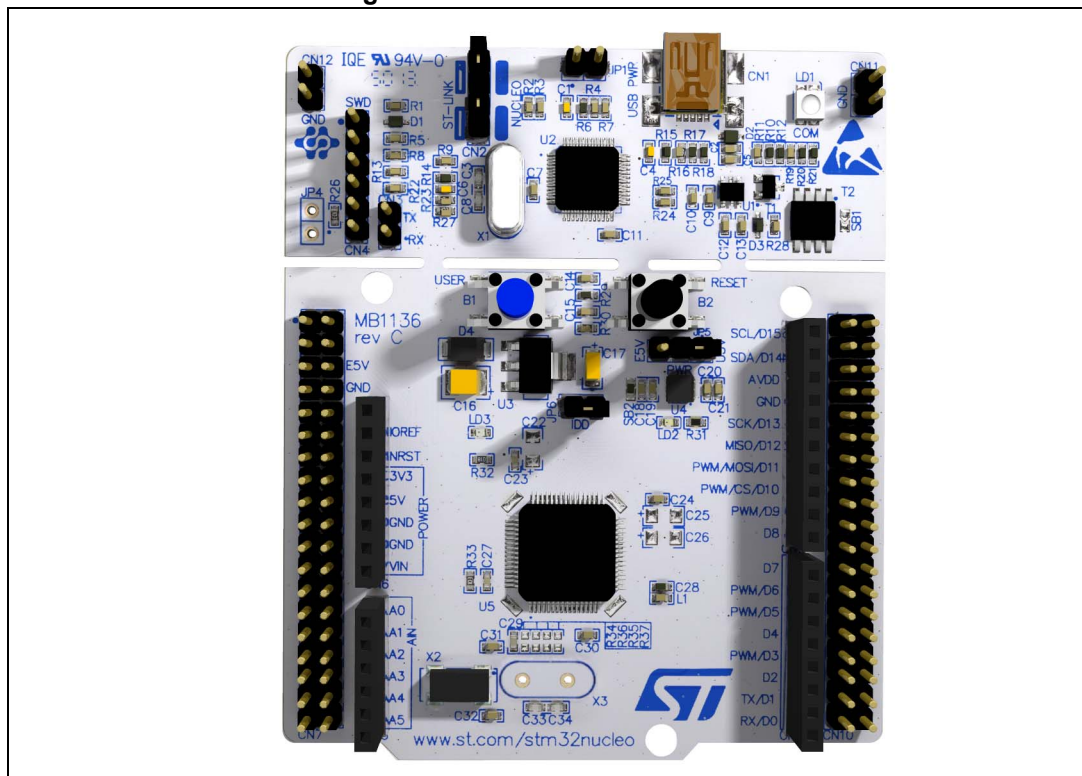

1. Picture not contractual.

Contents

- 1 Ordering information 6**
- 2 Conventions 7**
- 3 Quick start 8**
 - 3.1 Getting started 8
 - 3.2 System requirements 8
- 4 Features 9**
 - 4.1 Hardware configuration variants 9
- 5 Hardware layout and configuration 10**
 - 5.1 Cutable PCB 12
 - 5.2 Embedded ST-LINK/V2-1 13
 - 5.2.1 Drivers 14
 - 5.2.2 ST-LINK/V2-1 firmware upgrade 14
 - 5.2.3 Using the ST-LINK/V2-1 to program/debug the STM32 on board 14
 - 5.2.4 Using ST-LINK/V2-1 to program/debug an external STM32 application 15
 - 5.3 Power supply and power selection 16
 - 5.3.1 Power supply input from the USB connector 16
 - 5.3.2 External power supply inputs: VIN and EV5 17
 - 5.3.3 External power supply input: + 3V3 20
 - 5.3.4 External power supply output 20
 - 5.4 LEDs 20
 - 5.5 Push buttons 21
 - 5.6 JP6 (IDD) 21
 - 5.7 OSC clock 22
 - 5.7.1 OSC clock supply 22
 - 5.7.2 OSC 32 kHz clock supply 23
 - 5.8 USART communication 23
 - 5.9 Solder bridges 24
 - 5.10 Extension connectors 26
 - 5.11 Arduino connectors 31

	5.12 STMicroelectronics Morpho connector	42
6	Mechanical drawing	48
7	Electrical schematics	49
8	References	53
9	Revision history	53

List of tables

Table 1.	Ordering information	6
Table 2.	ON/OFF conventions	7
Table 3.	Jumper states	13
Table 4.	Debug connector CN4 (SWD)	15
Table 5.	JP1 configuration table	17
Table 6.	External power sources	18
Table 7.	Power-related jumper	18
Table 8.	+3.3V eternal power source	20
Table 9.	Solder bridges.	24
Table 10.	Arduino connectors on NUCLEO-F030R8, NUCLEO-F072RB.	31
Table 11.	Arduino connectors on NUCLEO-F103RB	33
Table 12.	Arduino connectors on NUCLEO-F302R8	35
Table 13.	Arduino connectors on NUCLEO-F334R8	36
Table 14.	Arduino connectors on NUCLEO-F401RE, NUCLEO-F411RE	38
Table 15.	Arduino connectors on NUCLEO-L053R8	39
Table 16.	Arduino connectors on NUCLEO-L152RE	40
Table 17.	STMicroelectronics Morpho connector on NUCLEO-F030R8	42
Table 18.	STMicroelectronics Morpho connector on NUCLEO-F072RB, NUCLEO-F334R8	43
Table 19.	STMicroelectronics Morpho connector on NUCLEO-F103RB	44
Table 20.	STMicroelectronics Morpho connector on NUCLEO-F302R8	45
Table 21.	STMicroelectronics Morpho connector on NUCLEO-F401RE, NUCLEO-F411RE	45
Table 22.	STMicroelectronics Morpho connector on NUCLEO-L152RE, NUCLEO-L053R8	47
Table 23.	Document revision history	53

List of figures

Figure 1.	STM32 Nucleo board ⁽¹⁾	1
Figure 2.	Hardware block diagram	10
Figure 3.	Top layout	11
Figure 4.	Bottom layout	12
Figure 5.	Typical configuration	13
Figure 6.	Updating the list of drivers in Device Manager	14
Figure 7.	Connecting the STM32 Nucleo board to program the on-board STM32	15
Figure 8.	Using ST-LINK/V2-1 to program the STM32 on an external application	16
Figure 9.	NUCLEO-F030R8	26
Figure 10.	NUCLEO-F072RB	26
Figure 11.	NUCLEO-F103RB	27
Figure 12.	NUCLEO-F302R8	27
Figure 13.	NUCLEO-F334R8	28
Figure 14.	NUCLEO-F401RE	28
Figure 15.	NUCLEO-F411RE	29
Figure 16.	NUCLEO-L053R8	29
Figure 17.	NUCLEO-L152RE	30
Figure 18.	STM32 Nucleo board mechanical drawing	48
Figure 19.	Schematic (1/4)	49
Figure 20.	Schematic (2/4)	50
Figure 21.	Schematic (3/4)	51
Figure 22.	Schematic (4/4)	52

1 Ordering information

Table 1 lists the order codes and the respective targeted MCU.

Table 1. Ordering information

Order code	Targeted MCU
NUCLEO-F030R8	STM32F030R8T6
NUCLEO-F072RB	STM32F072RBT6
NUCLEO-F103RB	STM32F103RBT6
NUCLEO-F302R8	STM32F302R8T6
NUCLEO-F334R8	STM32F334R8T6
NUCLEO-F401RE	STM32F401RET6
NUCLEO-F411RE	STM32F411RET6
NUCLEO-L053R8	STM32L053R8T6
NUCLEO-L152RE	STM32L152RET6

The meaning of NUCLEO-TXXXRY codification is as follows:

- TXXX describes the STM32 MCU product line
- R describes the pin count (R for 64 pins)
- Y describes the code size (8 for 64K, B for 128K, E for 512K)

The order code is printed on a sticker placed at the top or bottom side of the board.

2 Conventions

[Table 2](#) provides the conventions used for the ON and OFF settings in the present document.

Table 2. ON/OFF conventions

Convention	Definition
Jumper JP1 ON	Jumper fitted
Jumper JP1 OFF	Jumper not fitted
Solder bridge SBx ON	SBx connections closed by solder or 0 ohm resistor
Solder bridge SBx OFF	SBx connections left open

We refer to “STM32 Nucleo board” and “STM32 Nucleo boards” in this document for all information that is common to all sale types.

3 Quick start

The STM32 Nucleo board is a low-cost and easy-to-use development platform used to quickly evaluate and start a development with an STM32 microcontroller in LQFP64 package.

Before installing and using the product, please accept the Evaluation Product License Agreement from www.st.com/stm32nucleo.

For more information on the STM32 Nucleo boards and to access the demonstration software, visit www.st.com/stm32nucleo.

3.1 Getting started

Follow the sequence below to configure the STM32 Nucleo board and launch the demo software:

1. Check the jumper position on the board, JP1 off, JP5 (PWR) on U5V, JP6 on (IDD), CN2 on (NUCLEO) selected.
2. For correct identification of all device interfaces from the host PC, install the Nucleo USB driver available on www.st.com/stm32nucleo, prior to connecting the board
3. Connect the STM32 Nucleo board to a PC with a USB cable 'type A to mini-B' through USB connector CN1 to power the board. The red LED LD3 (PWR) and LD1 (COM) should light up. LD1 (COM) and green LED LD2 should blink.
4. Press button B1 (left button).
5. Observe how the blinking of the green LED LD2 changes according to clicks on button B1.
6. The demo software and several software examples on how use the STM32 Nucleo board features are available on www.st.com/stm32nucleo.
7. Develop your own application using the available examples.

3.2 System requirements

- Windows PC (XP, Vista, 7, 8)
- USB type A to Mini-B USB cable

4 Features

The STM32 Nucleo boards offer the following features:

- STM32 microcontroller with LQFP64 package
- Two types of extension resources
 - Arduino Uno Revision 3 connectivity
 - STMicroelectronics Morpho extension pin headers for full access to all STM32 I/Os
- mbed-enabled^(a)
- On-board ST-LINK/V2-1 debugger/programmer with SWD connector
 - selection-mode switch to use the kit as a standalone ST-LINK/V2-1
- Flexible board power supply
 - USB VBUS
 - External VIN (7V<VIN<12V) supply voltage from Arduino connectors or ST Morpho connector
 - External 5V (E5V) supply voltage from ST Morpho connector
 - External +3.3V supply voltage from Arduino connector or ST Morpho connector
- Three LEDs
 - USB communication (LD1), user LED (LD2), power LED (LD3)
- Two push buttons: USER and RESET
- LSE crystal:
 - 32.768kHz crystal oscillator (depending on board version)
- USB re-enumeration capability: three different interfaces supported on USB
 - Virtual Com port
 - Mass storage
 - Debug port
- Comprehensive free software HAL library including a variety of software examples
- Supported by wide choice of Integrated Development Environments (IDEs) including IAR, Keil, GCC-based IDEs

4.1 Hardware configuration variants

The board can be delivered with different configurations of the oscillator of the target MCU. For all the details concerning High Speed oscillator configurations refer to [Section 5.7.1](#). For all the details concerning Low speed oscillator configurations refer to [Section 5.7.2](#).

a. See <http://mbed.org/>

5 Hardware layout and configuration

The STM32 Nucleo board is designed around the STM32 microcontrollers in a 64-pin LQFP package.

Figure 2 shows the connections between the STM32 and its peripherals (ST-LINK/V2-1, pushbutton, LED, Arduino connectors and STMicroelectronics Morpho connector).

Figure 3 and *Figure 4* show the location of these features on the STM32 Nucleo board.

Figure 2. Hardware block diagram

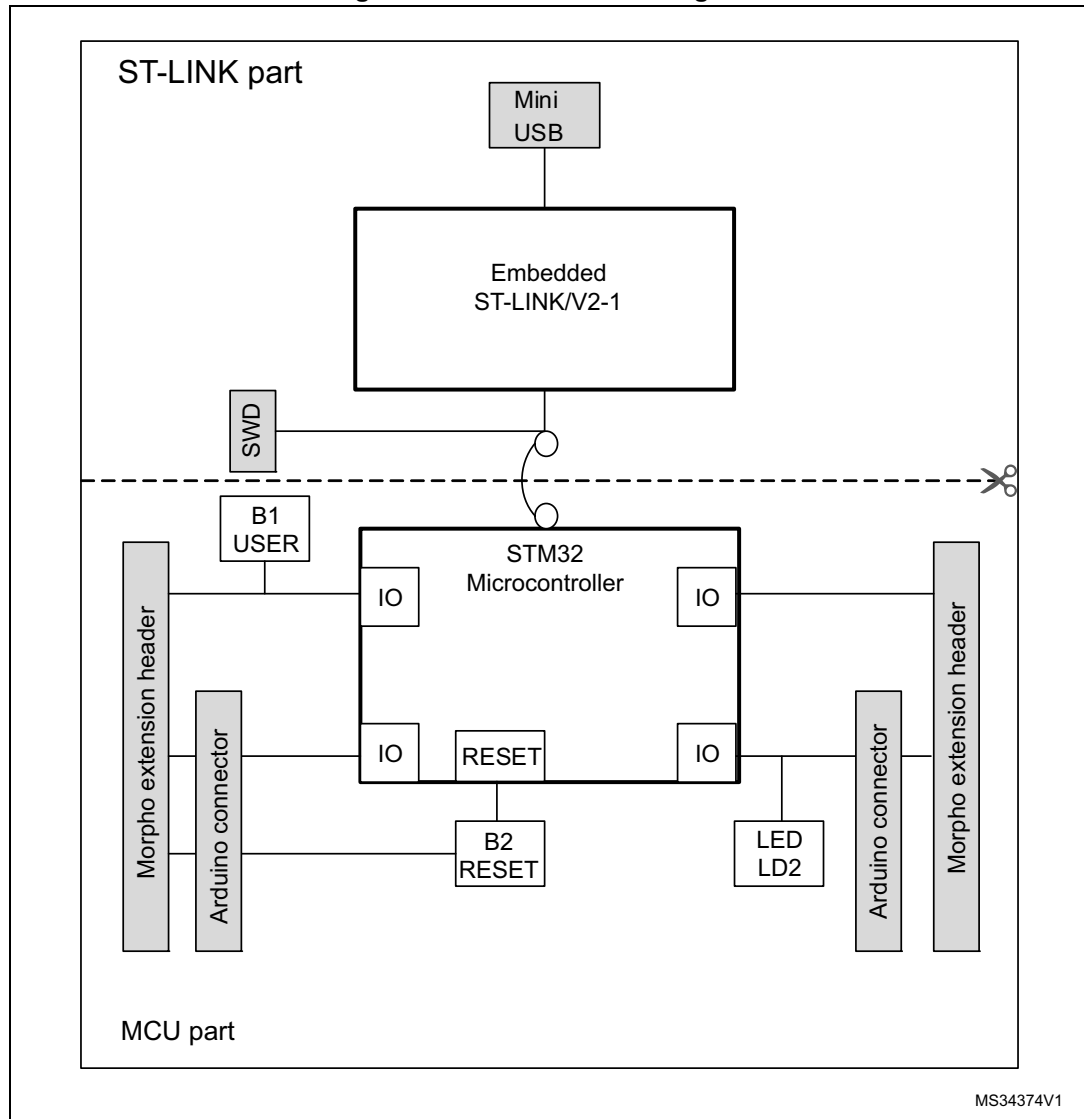
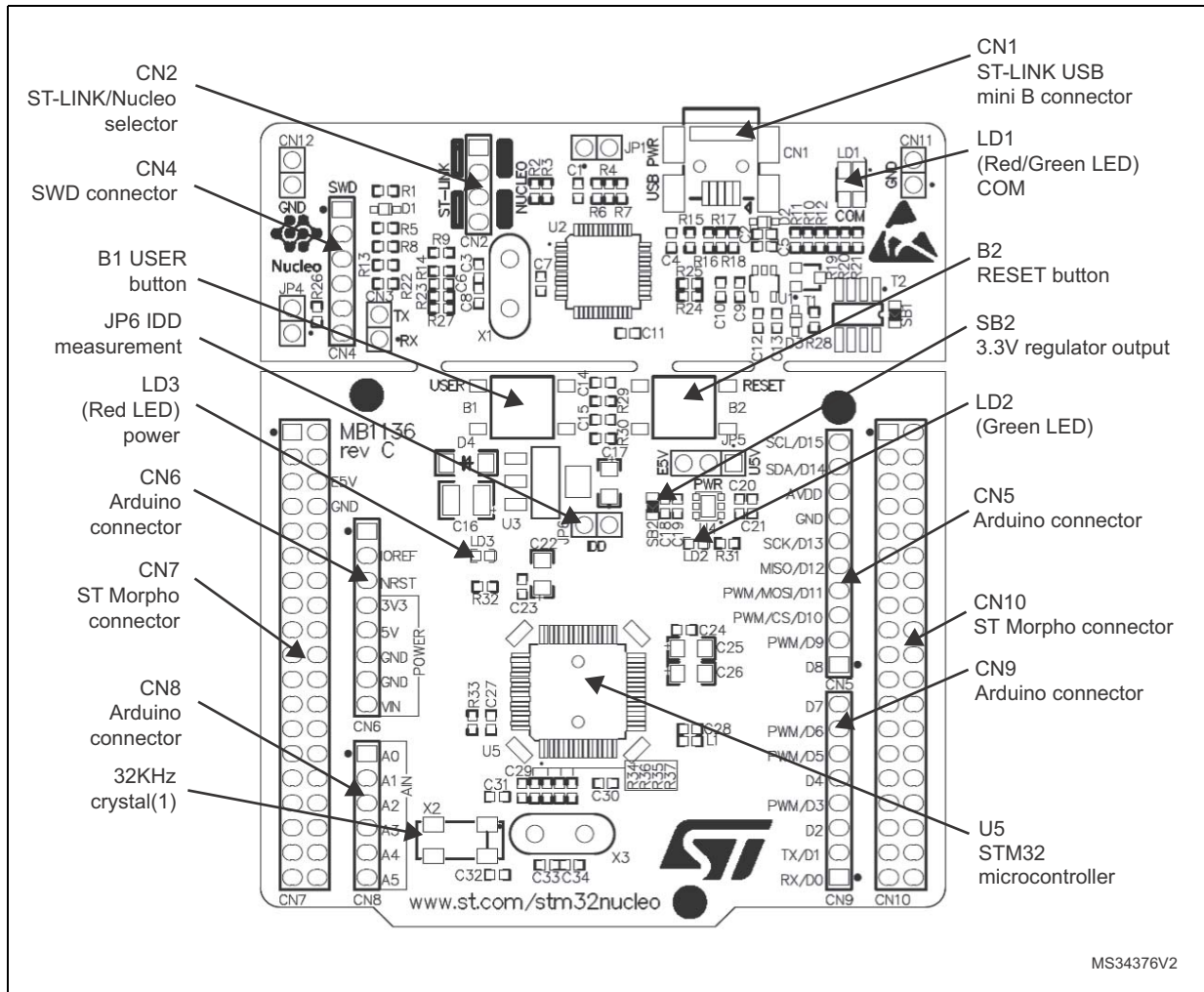
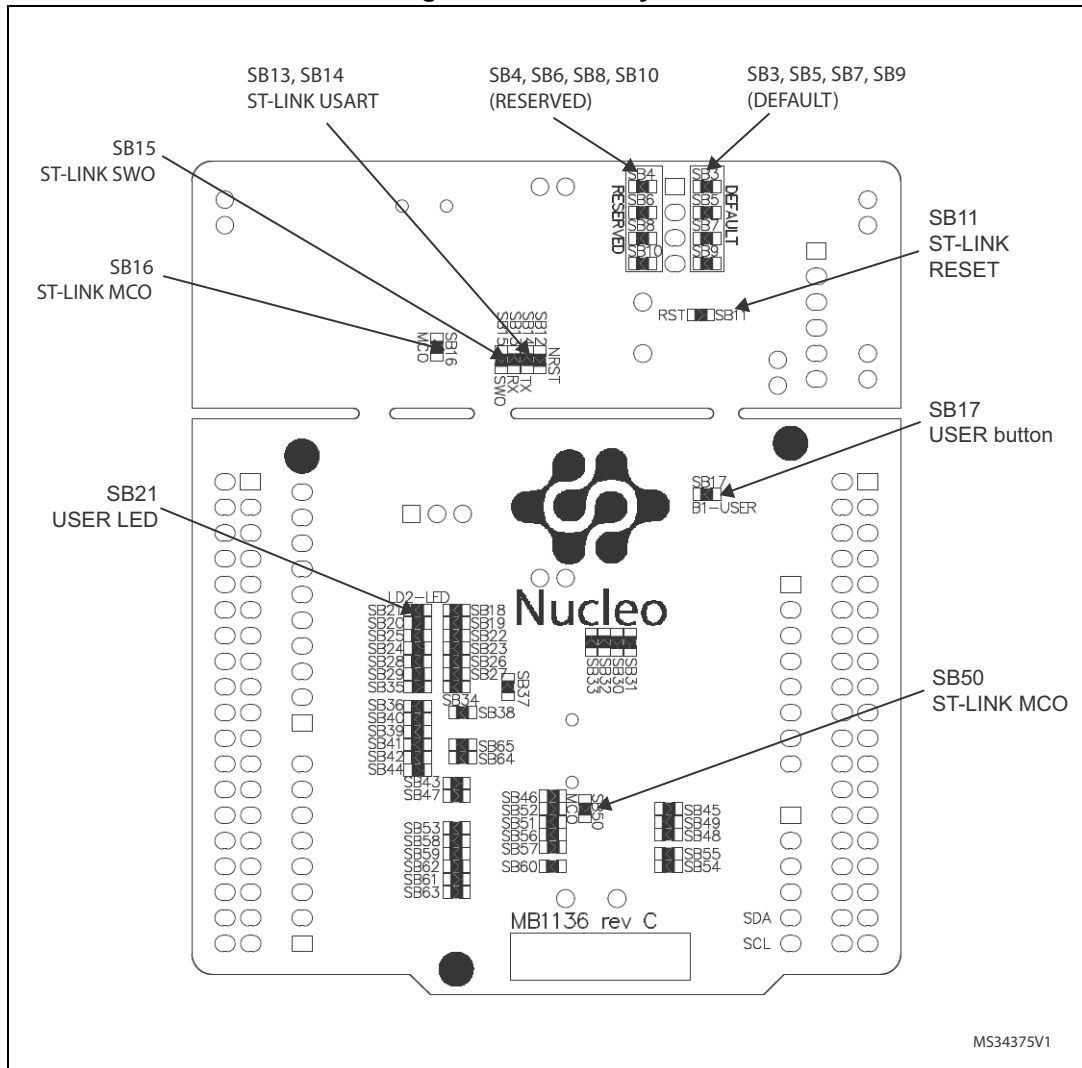

Figure 3. Top layout



1. Crystal may be present or not depending on board version, refer to [Section 5.7.2](#)

Figure 4. Bottom layout



5.1 Cutable PCB

The STM32 Nucleo board is divided into two parts: ST-LINK part and target MCU part. The ST-LINK part of the PCB can be cut out to reduce the board size. In this case the remaining target MCU part can only be powered by VIN, E5V and 3.3V on STMicroelectronics Morpho connector CN7 or VIN and 3.3V on Arduino connector CN6. It is still possible to use the ST-LINK part to program the main MCU using wires between CN4 and SWD signals available on STMicroelectronics Morpho connector (SWCLK CN7 pin 15 and SWDIO CN7 pin 13).

5.2 Embedded ST-LINK/V2-1

The ST-LINK/V2-1 programming and debugging tool is integrated in the STM32 Nucleo boards.

The ST-LINK/V2-1 makes the STM32 Nucleo boards mbed enabled.

The embedded ST-LINK/V2-1 supports only SWD for STM32 devices. For information about debugging and programming features refer to [UM1075 - ST-LINK/V2 in-circuit debugger/programmer for STM8 and STM32, User manual](#), which describes in detail all the ST-LINK/V2 features.

The changes versus ST-LINK/V2 version are listed below.

- New features supported on ST-LINK/V2-1:
 - USB software re-enumeration
 - Virtual com port interface on USB
 - Mass storage interface on USB
 - USB power management request for more than 100 mA power on USB
- Features not supported on ST-LINK/V2-1:
 - SWIM interface
 - Minimum supported application voltage limited to 3 V

There are two different ways to use the embedded ST-LINK/V2-1 depending on the jumper states (see [Table 3](#) and [Figure 5](#)):

- Program/debug the MCU on board ([Section 5.2.2](#)),
- Program/debug an MCU in an external application board using a cable connected to SWD connector CN4 ([Section 5.2.4](#)).

Table 3. Jumper states

Jumper state	Description
Both CN2 jumpers ON	ST-LINK/V2-1 functions enabled for on board programming (default)
Both CN2 jumpers OFF	ST-LINK/V2-1 functions enabled for external CN4 connector (SWD supported)

Figure 5. Typical configuration

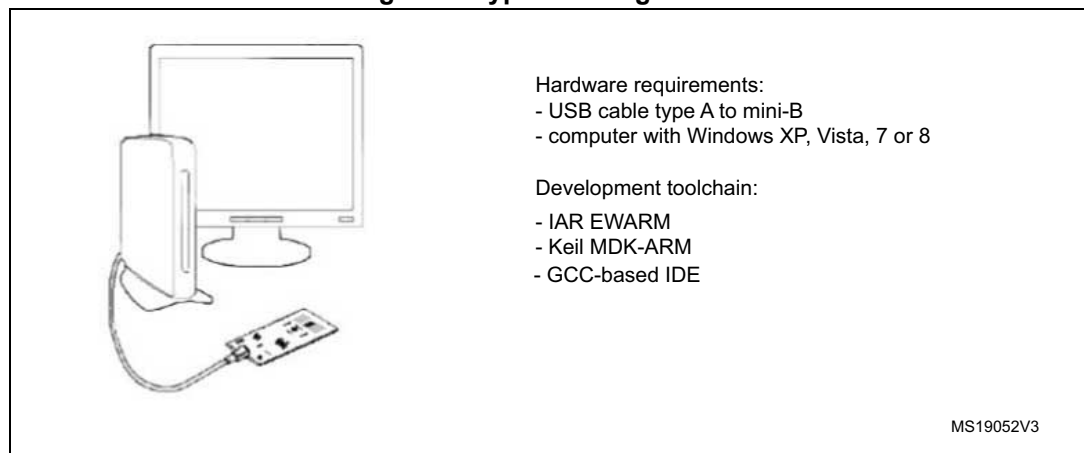

5.2.1 Drivers

The ST-LINK/V2-1 requires a dedicated USB driver, which can be found on www.st.com for Windows Vista, 7 and 8. On Windows XP the ST-LINK/V2-1 driver requires WinUsb to be installed before using the ST-LINK/V2-1 (either available from Microsoft website or included in the USB driver for ST-LINK/V2 for XP).

In case the STM32 Nucleo board is connected to the PC before the driver is installed, some Nucleo interfaces may be declared as “Unknown” in the PC device manager. In this case the user must install the driver files ([Figure 6](#)), and from the device manager update the driver of the connected device.

Note: Prefer using the “USB Composite Device” handle for a full recovery.

Figure 6. Updating the list of drivers in Device Manager

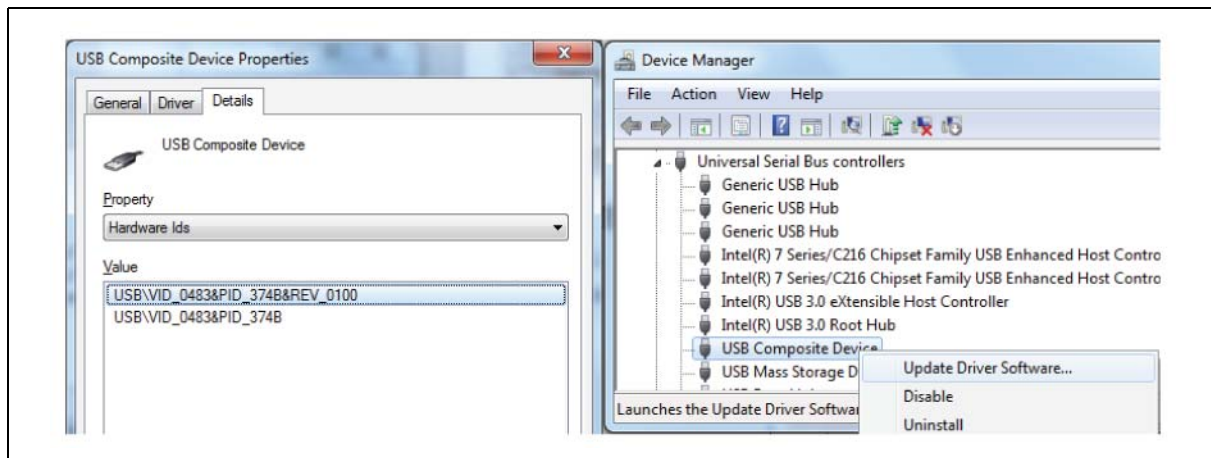

5.2.2 ST-LINK/V2-1 firmware upgrade

The ST-LINK/V2-1 embeds a firmware upgrade mechanism for in-situ upgrade through the USB port. As the firmware may evolve during the life time of the ST-LINK/V2-1 product (for example new functionality, bug fixes, support for new microcontroller families), it is recommended to visit www.st.com before starting to use the STM32 Nucleo board and periodically, in order to stay up-to-date with the latest firmware version.

5.2.3 Using the ST-LINK/V2-1 to program/debug the STM32 on board

To program the STM32 on the board, plug in the two jumpers on CN2, as shown in red in [Figure 7](#). Do not use the CN4 connector as this could disturb the communication with the STM32 microcontroller of the STM32 Nucleo board.

Figure 7. Connecting the STM32 Nucleo board to program the on-board STM32

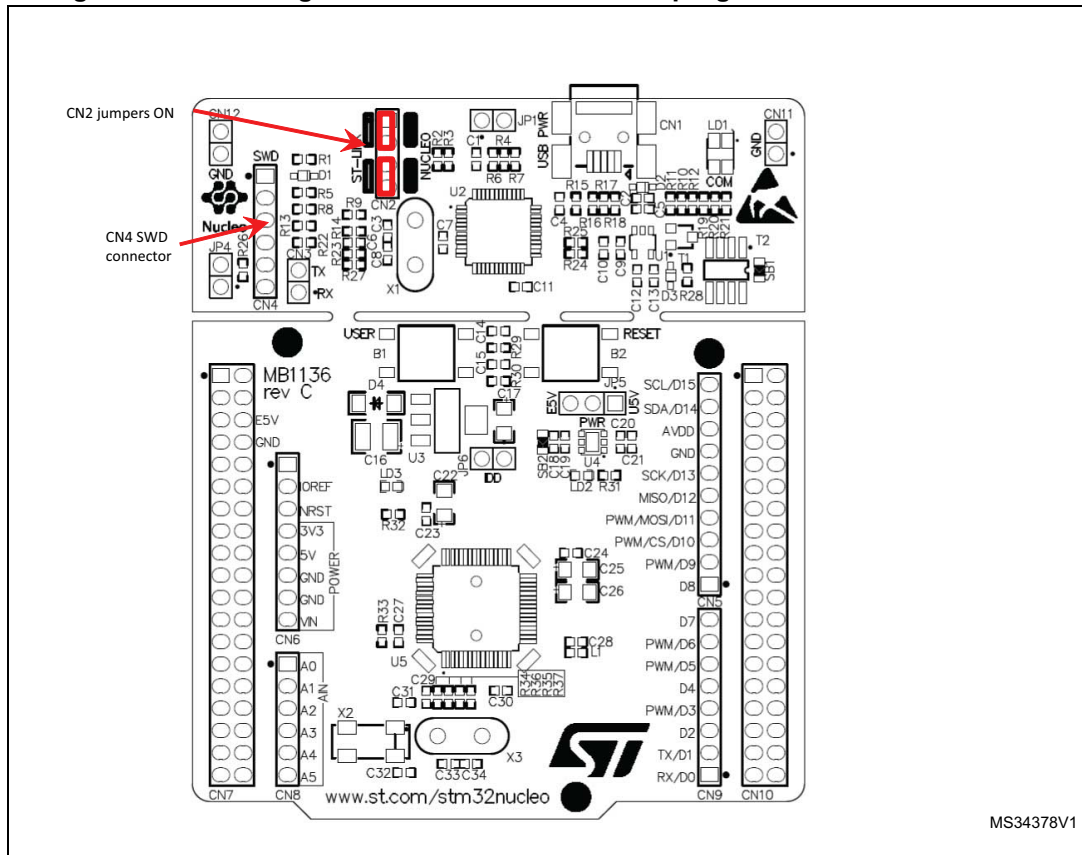

5.2.4 Using ST-LINK/V2-1 to program/debug an external STM32 application

It is very easy to use the ST-LINK/V2-1 to program the STM32 on an external application. Simply remove the two jumpers from CN2 as illustrated in [Figure 8](#), and connect your application to the CN4 debug connector according to [Table 4](#).

Note: **SB12 NRST (target MCU RESET) must be OFF if you use CN4 pin 5 in your external application.**

Table 4. Debug connector CN4 (SWD)

Pin	CN4	Designation
1	VDD_TARGET	VDD from application
2	SWCLK	SWD clock
3	GND	Ground
4	SWDIO	SWD data input/output
5	NRST	RESET of target MCU
6	SWO	Reserved

Figure 8. Using ST-LINK/V2-1 to program the STM32 on an external application

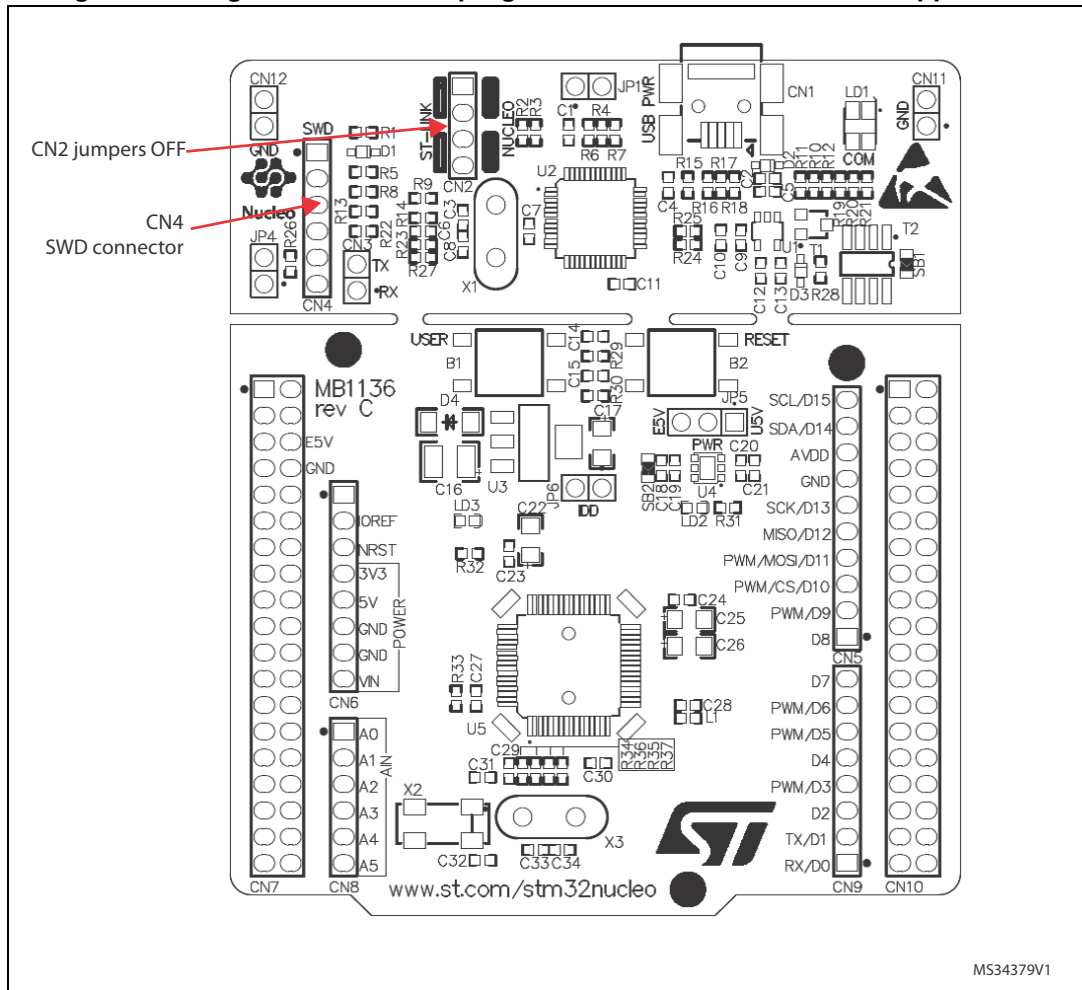

5.3 Power supply and power selection

The power supply is provided either by the host PC through the USB cable, or by an external Source: VIN (7V-12V), E5V (5V) or +3V3 power supply pins on CN6 or CN7. In case VIN, E5V or +3V3 is used to power the Nucleo board, using an external power supply unit or an auxiliary equipment, this power source must comply with the standard EN-60950-1: 2006+A11/2009, and must be Safety Extra Low Voltage (SELV) with limited power capability.

5.3.1 Power supply input from the USB connector

The ST-LINK/V2-1 supports USB power management allowing to request more than 100 mA current to the host PC.

All parts of the STM32 Nucleo board and shield can be powered from the ST-LINK USB connector CN1 (U5V or VBUS). Note that only the ST-LINK part is power supplied before the USB enumeration as the host PC only provides 100 mA to the board at that time. During the USB enumeration, the STM32 Nucleo board requires 300 mA of current to the Host PC. If the host is able to provide the required power, the targeted STM32 microcontroller is

powered and the red LED LD3 is turned ON, thus the STM32 Nucleo board and its shield can consume a maximum of 300 mA current, not more. If the host is not able to provide the required current, the targeted STM32 microcontroller and the MCU part including the extension board are not power supplied. As a consequence the red LED LD3 remains turned OFF. In such case it is mandatory to use an external power supply as explained in the next chapter.

When the board is power supplied by USB (U5V) a jumper must be connected between pin 1 and pin 2 of JP5 as shown in [Table 7](#).

JP1 is configured according to the maximum current consumption of the board when powered by USB (U5V). JP1 jumper can be set in case the board is powered by USB and maximum current consumption on U5V doesn't exceed 100mA (including an eventual extension board or Arduino Shield). In such condition USB enumeration will always succeed since no more than 100mA is requested to the PC. Possible configurations of JP1 are summarized in [Table 5](#).

Table 5. JP1 configuration table

Jumper state	Power supply	Allowed current
JP1 jumper OFF	USB power through CN1	300 mA max
JP1 jumper ON		100 mA max

Warning: If the maximum current consumption of the NUCLEO and its extension boards exceeds 300 mA, it is mandatory to power the NUCLEO using an external power supply connected to E5V or VIN.

Note: In case the board is powered by an USB charger, there is no USB enumeration, so the led LD3 remains set to OFF permanently and the target MCU is not powered. In this specific case the jumper JP1 needs to be set to ON, to allow target MCU to be powered anyway.

5.3.2 External power supply inputs: VIN and EV5

The external power sources VIN and EV5 are summarized in the [Table 6](#). When the board is power supplied by VIN or E5V, the jumpers configuration must be the following:

- Jumper on JP5 pin 2 and pin 3
- Jumper removed on JP1

Table 6. External power sources

Input power name	Connectors pins	Voltage range	Max current	Limitation
VIN	CN6 pin 8 CN7 pin 24	7 V to 12 V	800 mA	From 7 V to 12 V only and input current capability is linked to input voltage: 800 mA input current when $V_{in}=7\text{ V}$ 450 mA input current when $7\text{ V}<V_{in} (< \text{ or } =) 9\text{ V}$ 250 mA input current when $9\text{ V}<V_{in} (< \text{ or } =) 12\text{ V}$
E5V	CN7 pin 6	4.75 V to 5.25 V	500 mA	-

Table 7. Power-related jumper

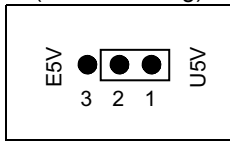
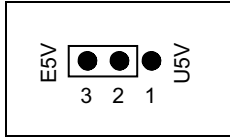
Jumper	Description
JP5	U5V (ST-LINK VBUS) is used as power source when JP5 is set as shown below (Default setting) 
	VIN or E5V is used as power source when JP5 is set as shown below. 

Using VIN or E5V as external power supply

VIN or E5V can be used as external power supply in case the current consumption of NUCLEO and extensions boards exceeds the allowed current on USB. In this condition it is still possible to use the USB for communication, for programming or debugging only, but it is mandatory to power supply the board first using VIN or E5V then connect the USB cable to the PC. Proceeding this way ensures that the enumeration occurs thanks to the external power source.

The following power sequence procedure must be respected:

1. Connect the jumper between pin 2 and pin 3 of JP5.
2. Check that JP1 is removed.
3. Connect the external power source to VIN or E5V.
4. Power on the external power supply $7\text{ V}< V_{IN} < 12\text{ V}$ to VIN, or 5 V for E5V.
5. Check that LD3 is turned ON.
6. Connect the PC to USB connector CN1.

If this order is not respected, the board may be supplied by VBUS first then by VIN or E5V, and the following risks may be encountered:

1. If more than 300 mA current is needed by the board, the PC may be damaged or the current supply can be limited by the PC. As a consequence the board is not powered correctly.
2. 300 mA is requested at enumeration (since JP1 must be OFF) so there is risk that the request is rejected and the enumeration does not succeed if the PC cannot provide such current. Consequently the board is not power supplied (LED LD3 remains OFF).

5.3.3 External power supply input: + 3V3

It can be of interest to use the +3V3 (CN6 pin 4 or CN7 pin 12 and pin 16) directly as power input for instance in case the 3.3 V is provided by an extension board. When NUCLEO is power supplied by +3V3, the ST-LINK is not powered thus the programming and debug features are unavailable. The external power sources +3.3V is summarized in the [Table 8](#).

Table 8. +3.3V external power source

Input power name	Connectors pins	Voltage range	Limitation
+3V3	CN6 pin 4 CN7 pin 12 and pin 16	3 V to 3.6 V	Used when ST-LINK part of PCB is cut or SB2 and SB12 OFF

Two different configurations are possible to use +3V3 to power the board:

- ST-LINK is removed (PCB cut), or
- SB2 (3V3 regulator) & SB12 (NRST) are OFF.

5.3.4 External power supply output

When powered by USB, VIN or E5V, the +5V (CN6 pin 5 or CN7 pin 18) can be used as output power supply for an Arduino shield or an extension board. In this case, the maximum current of the power source specified in [Table 6](#) needs to be respected.

The +3.3 V (CN6 pin 4 or CN7 pin 12 & 16) can be used also as power supply output. The current is limited by the maximum current capability of the regulator U4 (500 mA max).

5.4 LEDs

The tricolor LED (green, orange, red) LD1 (COM) provides information about ST-LINK communication status. LD1 default color is red. LD1 turns to green to indicate that communication is in progress between the PC and the ST-LINK/V2-1, with the following setup:

- Slow blinking Red/Off: at power-on before USB initialization
- Fast blinking Red/Off: after the first correct communication between the PC and ST-LINK/V2-1 (enumeration)
- Red LED On: when the initialization between the PC and ST-LINK/V2-1 is complete
- Green LED On: after a successful target communication initialization
- Blinking Red/Green: during communication with target
- Green On: communication finished and successful.
- Orange On: Communication failure

User LD2: the green LED is a user LED connected to Arduino signal D13 corresponding to MCU I/O PA5 (pin 21) or PB13 (pin 34) depending on the STM32 target. Please refer to [Table 10](#) to [Table 16](#).

- When the I/O is HIGH value, the LED is on.
- When the I/O is LOW, the LED is off.

LD3 PWR: the red LED indicates that the MCU part is powered and +5V power is available.

5.5 Push buttons

B1 USER: the user button is connected to the I/O PC13 (pin 2) of the STM32 microcontroller.

B2 RESET: this push button is connected to NRST, and is used to RESET the STM32 microcontroller.

Note: *The blue and black plastic hats that are placed on the push buttons can be removed if necessary, for example when a shield or when an application board is plugged on top of NUCLEO. This will avoid pressure on the buttons and consequently a possible permanent target MCU RESET.*

5.6 JP6 (IDD)

Jumper JP6, labeled IDD, is used to measure the STM32 microcontroller consumption by removing the jumper and by connecting an ammeter.

- Jumper ON: STM32 microcontroller is powered (default).
- Jumper OFF: an ammeter must be connected to measure the STM32 microcontroller current. If there is no ammeter, STM32 microcontroller is not powered.

5.7 OSC clock

5.7.1 OSC clock supply

There are four ways to configure the pins corresponding to external high-speed clock external high-speed clock (HSE):

- **MCO from ST-LINK:** MCO output of ST-LINK MCU is used as input clock. This frequency cannot be changed, it is fixed at 8 MHz and connected to PF0/PD0/PH0-OSC_IN of STM32 microcontroller.

The following configuration is needed:

- SB54, SB55 OFF
- R35,R37 removed
- SB16, SB50 ON

- **HSE oscillator on-board from X3 crystal (not provided):** for typical frequencies and its capacitors and resistors, please refer to STM32 microcontroller datasheet. Please refer to the AN2867 for oscillator design guide for STM32 microcontrollers..

The following configuration is needed:

- SB54, SB55 OFF
- R35, R37 soldered
- C33, C34 soldered
- SB16, SB50 OFF

- **Oscillator from external PF0/PD0/PH0:** from an external oscillator through pin 29 of the CN7 connector.

The following configuration is needed:

- SB55 ON
- SB50 OFF
- R35,R37 removed

- **HSE not used:** PF0/PD0/PH1 and PF1/PD1/PH1 are used as GPIO instead of Clock

The following configuration is needed:

- SB54 & SB55 ON
- R35 and R37 removed
- SB50 (MCO) OFF

There are two possible default configurations of the HSE pins depending on the version of NUCLEO board hardware.

The board version MB1136 C-01 or MB1136 C-02 is mentioned on sticker placed on bottom side of the PCB.

The board marking MB1136 C-01 corresponds to a board, configured for HSE not used.

The board marking MB1136 C-02 corresponds to a board, configured to use ST-LINK MCO as clock input.

5.7.2 OSC 32 kHz clock supply

There are three ways to configure the pins corresponding to low-speed clock (LSE):

- **On-board oscillator:** X2 crystal. Please refer to the AN2867 for oscillator design guide for STM32 microcontrollers.

The following configuration is needed:

- SB48, SB49 OFF
- R34 and R36 soldered.
- C31, C32 soldered

- **Oscillator from external PC14:** from external oscillator through the pin 25 of CN7 connector.

The following configuration is needed:

- SB48, SB49 ON
- R34 and R36 removed

- **LSE not used:** PC14 and PC15 are used as GPIOs instead of low speed Clock.

The following configuration is needed:

- SB48 & SB49 ON
- R34 and R36 removed

There are two possible default configurations of the LSE depending on the version of NUCLEO board hardware.

The board version MB1136 C-01 or MB1136 C-02 is mentioned on sticker placed on bottom side of the PCB.

The board marking MB1136 C-01 corresponds to a board configured as LSE not used.

The board marking MB1136 C-02 corresponds to a board configured with on-board 32kHz oscillator.

5.8 USART communication

The USART2 interface available on PA2 and PA3 of the STM32 microcontroller can be connected to ST-LINK MCU, STMicroelectronics Morpho connector or to Arduino connector. The choice can be changed by setting the related solder bridges. By default the USART2 communication between the target MCU and ST-LINK MCU is enabled in order to support Virtual Com Port for mbed (SB13 and SB14 ON, SB62 and SB63 OFF). If the communication between the target MCU PA2 (D1) or PA3 (D0) and shield or extension board is required, SB62 and SB63 should be ON, SB13 and SB14 should be OFF. In such case it possible to connect another USART to ST-LINK MCU using flying wires between Morpho connector and CN3. For instance on NUCLEO-F103RB it is possible to use USART3 available on PC10 (TX) & PC11 (RX). Two flying wires need to be connected as follow:

- PC10 (USART3_TX) available on CN7 pin 1 to CN3 pin RX
- PC11 (USART3_RX) available on CN7 pin 2 to CN3 pin TX

5.9 Solder bridges

Table 9. Solder bridges

Bridge	State ⁽¹⁾	Description
SB54, SB55 (X3 crystal) ⁽²⁾	OFF	X3, C33, C34, R35 and R37 provide a clock as shown in Chapter 7: Electrical schematics PF0/PD0/PH0, PF1/PD1/PH1 are disconnected from CN7.
	ON	PF0/PD0/PH0, PF1/PD1/PH1 are connected to CN12. (R35, R37 and SB50 must not be fitted).
SB3,5,7,9 (DEFAULT)	ON	Reserved, do not modify.
SB4,6,8,10 (RESERVED)	OFF	Reserved, do not modify.
SB48,49 (X2 crystal) ⁽³⁾	OFF	X2, C31, C32, R34 and R36 deliver a 32 kHz clock. PC14, PC15 are not connected to CN7.
	ON	PC14, PC15 are only connected to CN7. Remove only R34, R36
SB17 (B1-USER)	ON	B1 push button is connected to PC13.
	OFF	B1 push button is not connected to PC13.
SB12 (NRST)	ON	The NRST signal of the CN4 connector is connected to the NRST pin of the STM32 MCU.
	OFF	The NRST signal of the CN4 connector is not connected to the NRST pin of the STM MCU.
SB15 (SWO)	ON	The SWO signal of the CN4 connector is connected to PB3.
	OFF	The SWO signal is not connected.
SB11 (STM_RST)	OFF	No incidence on STM32F103CBT6 (ST-LINK MCU) NRST signal.
	ON	STM32F103CBT6 (ST-LINK MCU) NRST signal is connected to GND.
SB1 (USB-5V)	OFF	USB power management is functional.
	ON	USB power management is disabled.
SB2 (3.3 V)	ON	Output of voltage regulator LD39050PU33R is connected to 3.3V.
	OFF	Output of voltage regulator LD39050PU33R is not connected.
SB21 (LD2-LED)	ON	Green user LED LD2 is connected to D13 of Arduino signal.
	OFF	Green user LED LD2 is not connected.
SB56,SB51 (A4 and A5)	ON	PC1 and PC0 (ADC in) are connected to A4 and A5 (pin 5 and pin 6) on Arduino connector CN8 and ST Morpho connector CN7. Thus SB46 and SB52 should be OFF.
	OFF	PC1 and PC0 (ADC in) are disconnected to A4 and A5 (pin 5 and pin 6) on Arduino connector CN8 and ST Morpho connector CN7.
SB46,SB52 (I2C on A4 and A5)	OFF	PB9 and PB8 (I2C) are disconnected to A4 and A5 (pin 5 and pin 6) on Arduino connector CN8 and ST Morpho connector CN7.
	ON	PB9 and PB8 (I2C) are connected to A4 and A5 (pin 5 and pin 6) on Arduino connector CN8 and ST Morpho connector CN7 as I2C signals. Thus SB56 and SB51 should be OFF.
SB45 (VBAT/VLCD)	ON	VBAT or VLCD on STM32 MCU is connected to VDD.
	OFF	VBAT or VLCD on STM32 MCU is not connected to VDD.

Table 9. Solder bridges (continued)

Bridge	State ⁽¹⁾	Description
SB57 (VREF+)	ON	VREF+ on STM32 MCU is connected to VDD.
	OFF	VREF+ on STM32 MCU is not connected to VDD and can be provided from pin 7 of CN10
SB62, SB63 (USART)	ON	PA2 and PA3 on STM32 MCU are connected to D1 and D0 (pin 7 and pin 8) on Arduino connector CN9 and ST Morpho connector CN10 as USART signals. Thus SB13 and SB14 should be OFF.
	OFF	PA2 and PA3 on STM32 MCU are disconnected to D1 and D0 (pin 7 and pin 8) on Arduino connector CN9 and ST Morpho connector CN10.
SB13, SB14 (ST-LINK-USART)	OFF	PA2 and PA3 on STM32F103CBT6 (ST-LINK MCU) are disconnected to PA3 and PA2 on STM32 MCU.
	ON	PA2 and PA3 on STM32F103CBT6 (ST-LINK MCU) are connected to PA3 and PA2 on STM32 MCU to have USART communication between them. Thus SB61, SB62 and SB63 should be OFF.
SB16, SB50 (MCO) ⁽²⁾	OFF	MCO on STM32F103CBT6 (ST-LINK MCU) are disconnected to PF0/PD0/PH0 on STM32 MCU.
	ON	MCO on STM32F103CBT6 (ST-LINK MCU) are connected to PF0/PD0/PH0 on STM32 MCU.

1. The default SBx state is shown in bold.
2. Default configuration depends on board version. Please refer to chapter 5.7.1 for details
3. Default configuration depends on board version. Please refer to chapter 5.7.2 for details.

All the other solder bridges present on the STM32 Nucleo board are used to configure several IOs and power supply pins for compatibility of features and pinout with STM32 MCU supported.

All STM32 Nucleo boards are delivered with the solder-bridges configured according to the target MCU supported.

5.10 Extension connectors

The following figures show the signals connected by default to Arduino Uno Revision 3 connectors (CN5, CN6, CN8, CN9) and to STMicroelectronics Morpho connector (CN7 and CN10), for each STM32 Nucleo board.

Figure 9. NUCLEO-F030R8

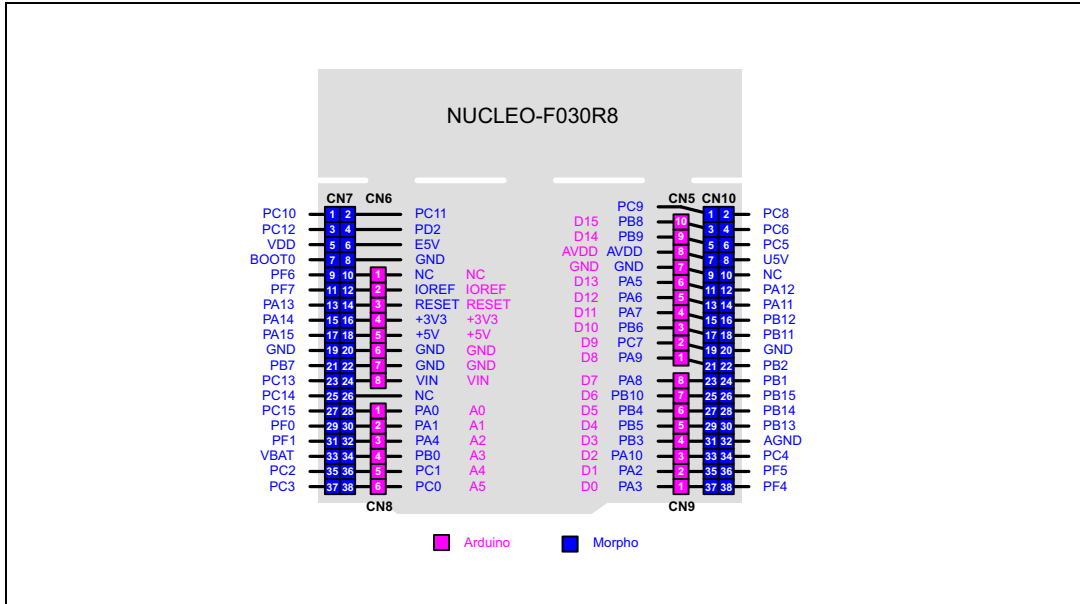

Figure 10. NUCLEO-F072RB

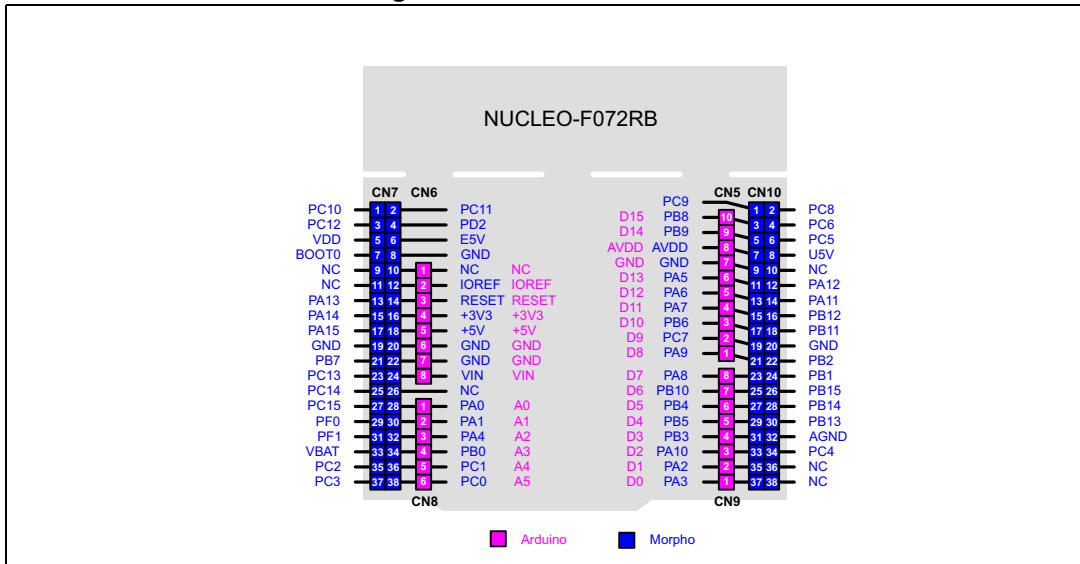

Figure 11. NUCLEO-F103RB

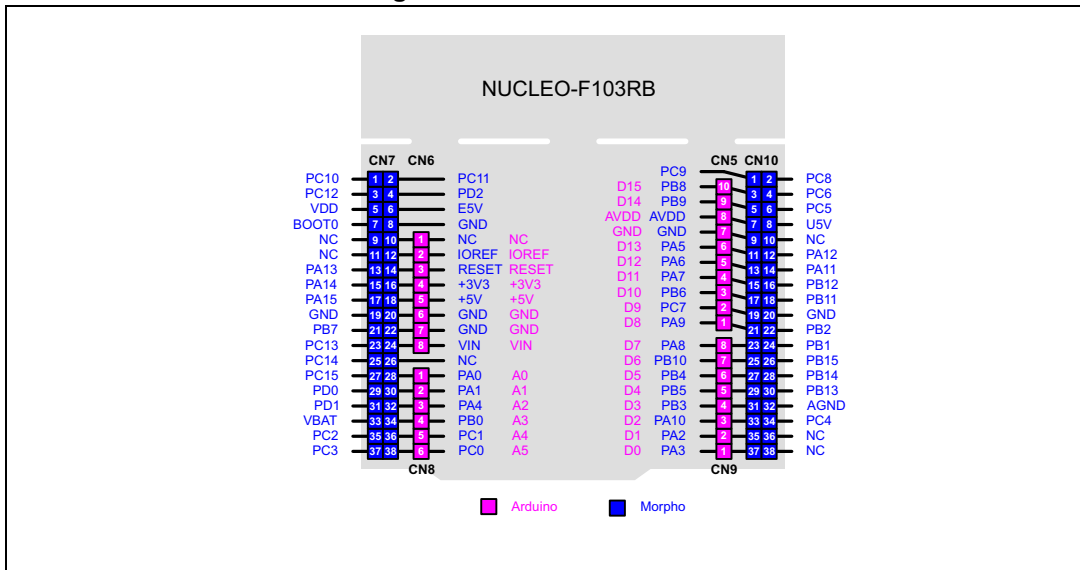

Figure 12. NUCLEO-F302R8

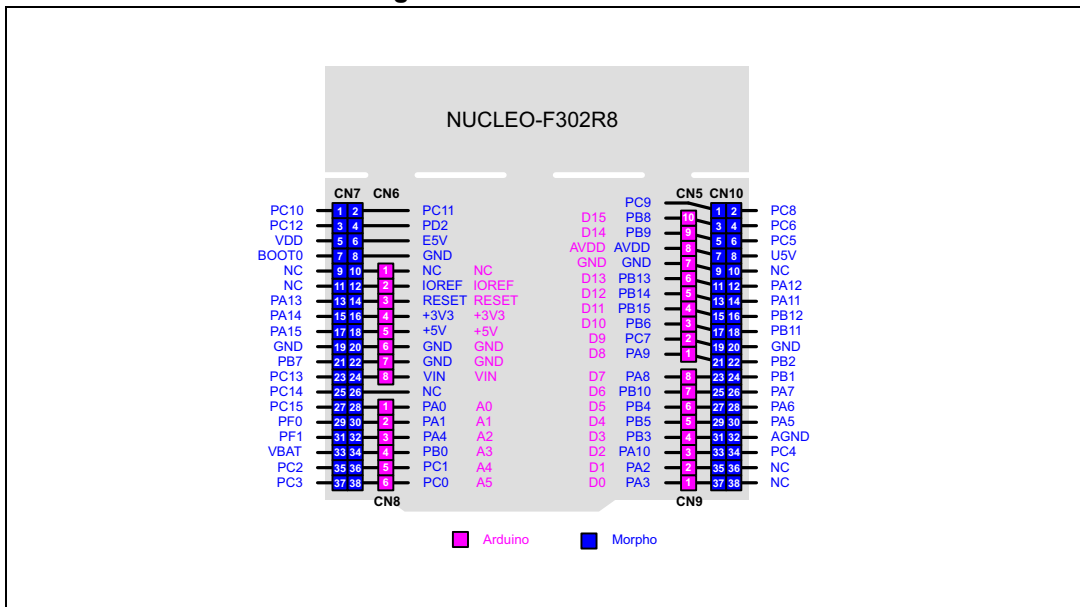

Figure 13. NUCLEO-F334R8

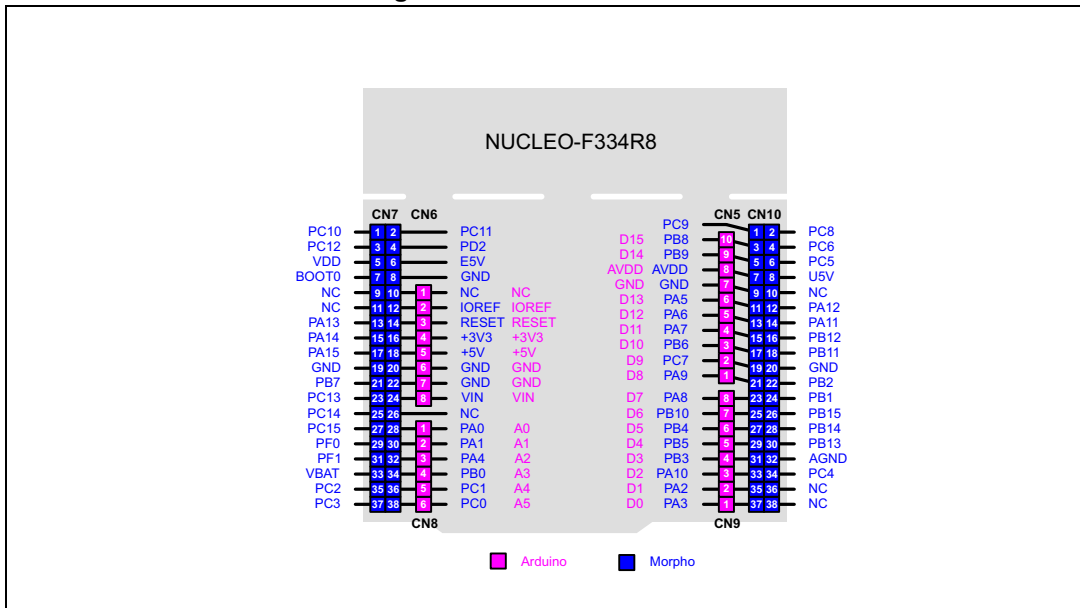

Figure 14. NUCLEO-F401RE

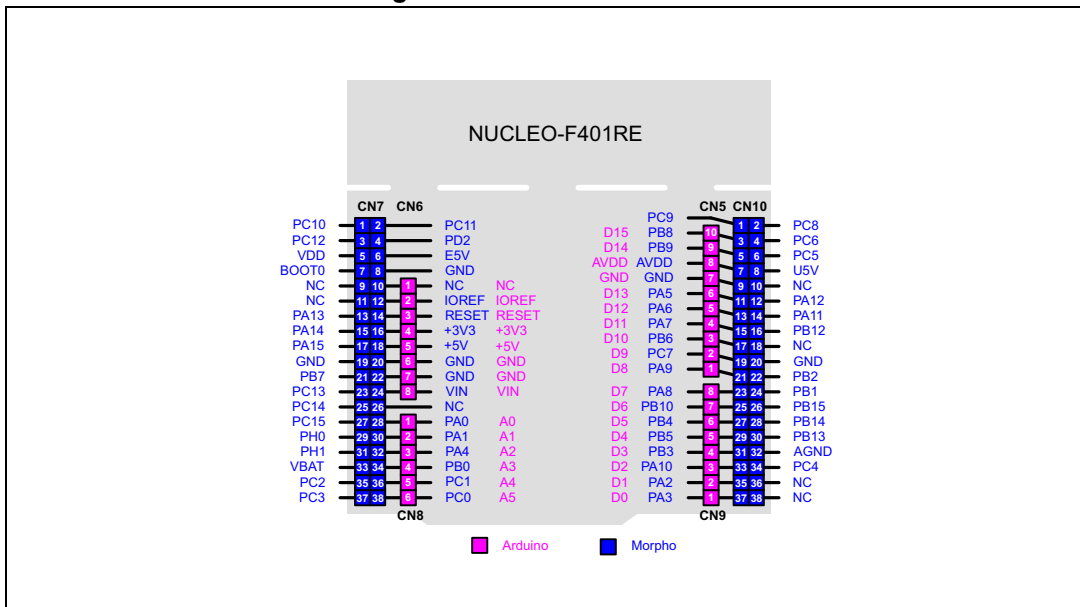

Figure 15. NUCLEO-F411RE

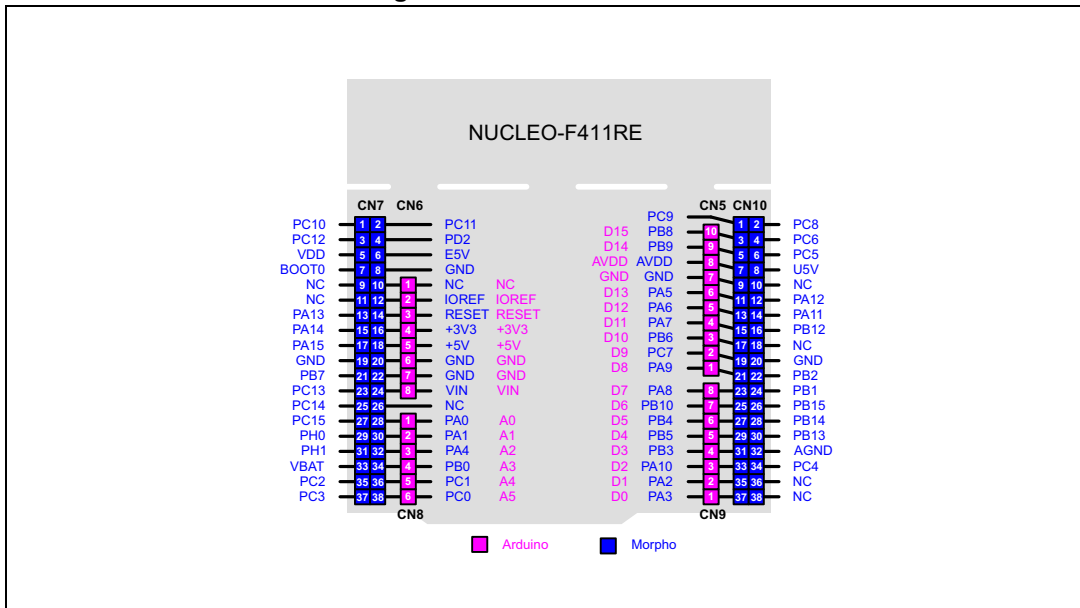

Figure 16. NUCLEO-L053R8

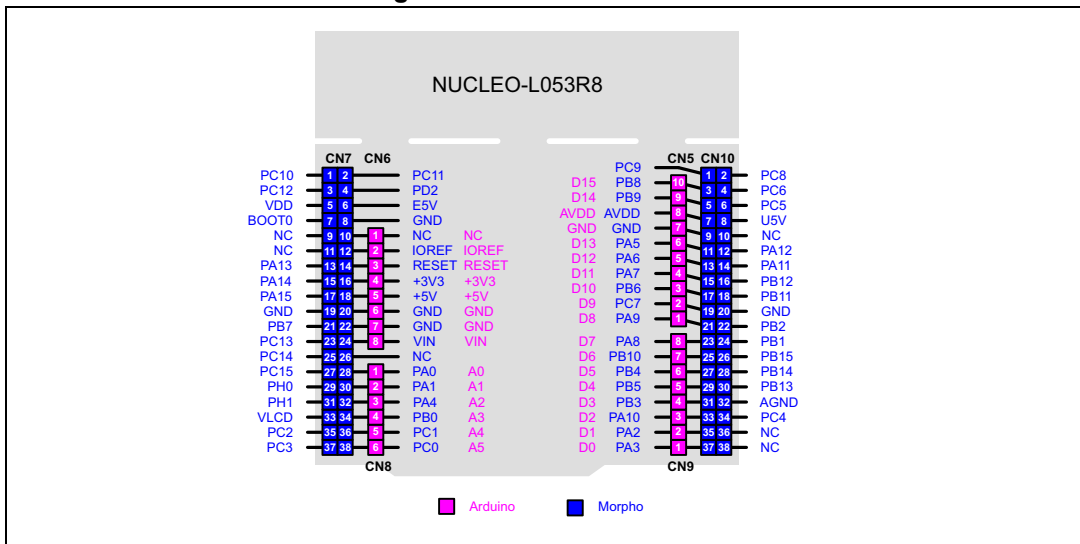
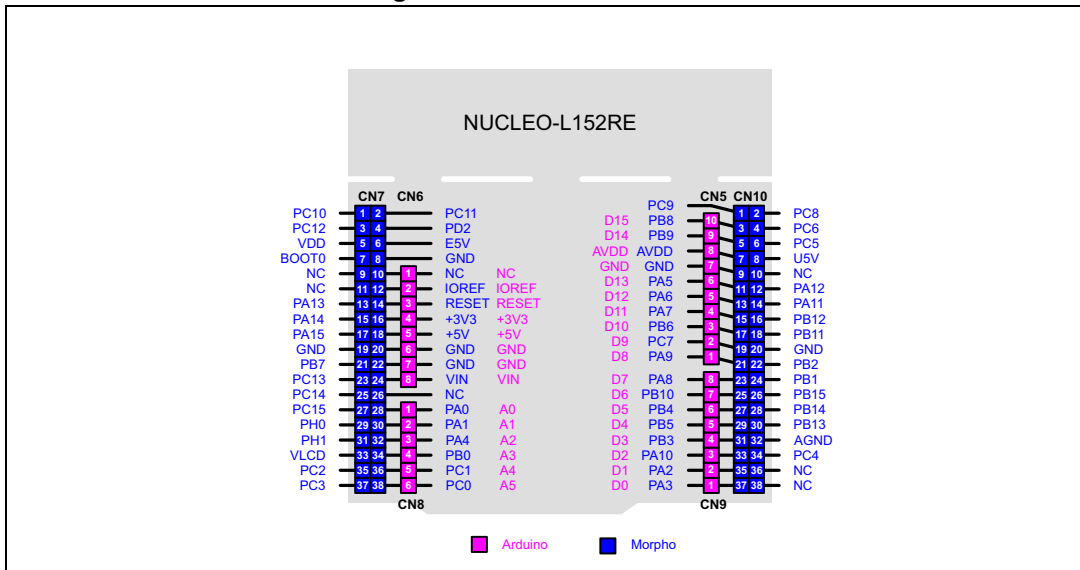

Figure 17. NUCLEO-L152RE



5.11 Arduino connectors

CN5, CN6, CN8 and CN9 are female connectors compatible with Arduino standard. Most shields designed for Arduino can fit to the STM32 Nucleo boards.

The Arduino connectors on STM32 Nucleo board support the Arduino Uno Revision 3.

For compatibility with Arduino Uno Revision 1, apply the following modifications:

- SB46 and SB52 should be ON,
- SB51 and SB56 should be OFF to connect I2C on A4 (pin 5) and A5 (pin 6 of CN8).

Caution: The IOs of STM32 microcontroller are 3.3 V compatible instead of 5 V for Arduino Uno.

[Table 10](#) to [Table 16](#) show the pin assignment of each main STM32 microcontroller on Arduino connectors.

Table 10. Arduino connectors on NUCLEO-F030R8, NUCLEO-F072RB

CN No.	Pin No.	Pin name	MCU pin	Function
Left connectors				
CN6 power	1	NC	-	-
	2	IOREF	-	3.3V Ref
	3	RESET	NRST	RESET
	4	+3V3	-	3.3V input/output
	5	+5V	-	5V output
	6	GND	-	Ground
	7	GND	-	Ground
	8	VIN	-	Power input
CN8 analog	1	A0	PA0	ADC_IN0
	2	A1	PA1	ADC_IN1
	3	A2	PA4	ADC_IN4
	4	A3	PB0	ADC_IN8
	5	A4	PC1 or PB9 ⁽¹⁾	ADC_IN11 (PC1) or I2C1_SDA (PB9)
	6	A5	PC0 or PB8 ⁽¹⁾	ADC_IN10 (PC0) or I2C1_SCL (PB8)

Table 10. Arduino connectors on NUCLEO-F030R8, NUCLEO-F072RB (continued)

CN No.	Pin No.	Pin name	MCU pin	Function
Right connectors				
CN5 digital	10	D15	PB8	I2C1_SCL
	9	D14	PB9	I2C1_SDA
	8	AREF	-	AVDD
	7	GND	-	Ground
	6	D13	PA5	SPI1_SCK
	5	D12	PA6	SPI1_MISO
	4	D11	PA7	TIM17_CH1 or SPI1_MOSI
	3	D10	PB6	TIM16_CH1N or SPI1_CS
	2	D9	PC7	TIM3_CH2
	1	D8	PA9	-
CN9 digital	8	D7	PA8	-
	7	D6	PB10	TIM2_CH3 ⁽²⁾
	6	D5	PB4	TIM3_CH1
	5	D4	PB5	-
	4	D3	PB3	TIM2_CH2 ⁽³⁾
	3	D2	PA10	-
	2	D1	PA2	USART2_TX
	1	D0	PA3	USART2_RX

1. Please refer to [Table 9: Solder bridges](#) for details.
2. Warning: PWM is not supported by D6 on STM32F030 since the timer is not available on PB10.
3. Warning: PWM is not supported by D3 on STM32F030 since timer is not available on PB3.

Table 11. Arduino connectors on NUCLEO-F103RB

Connect or No.	Pin No.	Pin name	MCU pin	Function
Left connectors				
CN6 power	1	NC	-	-
	2	IOREF	-	3.3V Ref
	3	RESET	NRST	RESET
	4	+3V3	-	3.3V input/output
	5	+5V	-	5V output
	6	GND	-	Ground
	7	GND	-	Ground
	8	VIN	-	Power input
CN8 analog	1	A0	PA0	ADC_0
	2	A1	PA1	ADC_1
	3	A2	PA4	ADC_4
	4	A3	PB0	ADC_8
	5	A4	PC1 or PB9 ⁽¹⁾	ADC_11 (PC1) or I2C1_SDA (PB9)
	6	A5	PC0 or PB8 ⁽¹⁾	ADC_10 (PC0) or I2C1_SCL (PB8)
Right connectors				
CN5 digital	10	D15	PB8	I2C1_SCL
	9	D14	PB9	I2C1_SDA
	8	AREF	-	AVDD
	7	GND	-	Ground
	6	D13	PA5	SPI1_SCK
	5	D12	PA6	SPI1_MISO
	4	D11	PA7	TIM3_CH2 or SPI1_MOSI
	3	D10	PB6	TIM4_CH1 or SPI1_CS
	2	D9	PC7	TIM3_CH2
	1	D8	PA9	-

Table 11. Arduino connectors on NUCLEO-F103RB (continued)

Connect or No.	Pin No.	Pin name	MCU pin	Function
CN9 digital	8	D7	PA8	-
	7	D6	PB10	TIM2_CH3
	6	D5	PB4	TIM3_CH1
	5	D4	PB5	-
	4	D3	PB3	TIM2_CH2
	3	D2	PA10	-
	2	D1	PA2	USART2_TX
	1	D0	PA3	USART2_RX

1. Please refer to [Table 9: Solder bridges](#) for detail.

Table 12. Arduino connectors on NUCLEO-F302R8

Connect or No.	Pin No.	Pin name	MCU pin	Function
Left connectors				
CN6 Power	1	NC	-	-
	2	IOREF	-	3.3V Ref
	3	RESET	NRST	RESET
	4	+3V3	-	3.3V input/output
	5	+5V	-	5V output
	6	GND	-	Ground
	7	GND	-	Ground
	8	VIN	-	Power input
CN8 Analog	1	A0	PA0	ADC_IN1
	2	A1	PA1	ADC_IN2
	3	A2	PA4	ADC_IN5
	4	A3	PB0	ADC_IN11
	5	A4	PC1 or PB9 ⁽¹⁾	ADC_IN7 (PC1) or I2C1_SDA (PB9)
	6	A5	PC0 or PB8 ⁽¹⁾	ADC_IN6 (PC0) or I2C1_SCL (PB8)
Right connectors				
CN5 digital	10	D15	PB8	I2C1_SCL
	9	D14	PB9	I2C1_SDA
	8	AREF	-	AVDD
	7	GND	-	Ground
	6	D13	PB13	SPI2_SCK
	5	D12	PB14	SPI2_MISO
	4	D11	PB15	TIM15_CH2 or SPI2_MOSI
	3	D10	PB6	TIM16_CH1N or SPI2_CS
	2	D9	PC7	-
	1	D8	PA9	-

Table 12. Arduino connectors on NUCLEO-F302R8 (continued)

Connect or No.	Pin No.	Pin name	MCU pin	Function
CN9 digital	8	D7	PA8	-
	7	D6	PB10	TIM2_CH3
	6	D5	PB4	TIM16_CH1
	5	D4	PB5	-
	4	D3	PB3	TIM2_CH2
	3	D2	PA10	-
	2	D1	PA2	USART2_TX
	1	D0	PA3	USART2_RX

1. Please refer to [Table 9: Solder bridges](#) for details.

Warning: PWM is not supported by D9 on STM32F302 since the timer is not available on PC7.

Table 13. Arduino connectors on NUCLEO-F334R8

Connect or No.	Pin No.	Pin name	MCU pin	Function
Left connectors				
CN6 power	1	NC	-	-
	2	IOREF	-	3.3V Ref
	3	RESET	NRST	RESET
	4	+3V3	-	3.3V input/output
	5	+5V	-	5V output
	6	GND	-	Ground
	7	GND	-	Ground
	8	VIN	-	Power input
CN8 analog	1	A0	PA0	ADC1_IN1
	2	A1	PA1	ADC1_IN2
	3	A2	PA4	ADC2_IN1
	4	A3	PB0	ADC1_IN11
	5	A4	PC1 or PB9 ⁽¹⁾	ADC_IN7 (PC1) or I2C1_SDA (PB9)
	6	A5	PC0 or PB8 ⁽¹⁾	ADC_IN6 (PC0) or I2C1_SCL (PB8)

Table 13. Arduino connectors on NUCLEO-F334R8 (continued)

Connect or No.	Pin No.	Pin name	MCU pin	Function
CN5 digital	10	D15	PB8	I2C1_SCL
	9	D14	PB9	I2C1_SDA
	8	AREF	-	AVDD
	7	GND	-	Ground
	6	D13	PA5	SPI1_SCK
	5	D12	PA6	SPI1_MISO
	4	D11	PA7	TIM17_CH1 or SPI1_MOSI
	3	D10	PB6	TIM16_CH1N or SPI1_CS
	2	D9	PC7	TIM3_CH2
	1	D8	PA9	-
CN9 digital	8	D7	PA8	-
	7	D6	PB10	TIM2_CH3
	6	D5	PB4	TIM3_CH1
	5	D4	PB5	-
	4	D3	PB3	TIM2_CH2
	3	D2	PA10	-
	2	D1	PA2	USART2_TX
	1	D0	PA3	USART2_RX

1. Please refer to [Table 9: Solder bridges](#) for details.

Table 14. Arduino connectors on NUCLEO-F401RE, NUCLEO-F411RE

CN No.	Pin No.	Pin name	MCU pin	Function
Left connectors				
CN6 power	1	NC	-	-
	2	IOREF	-	3.3V Ref
	3	RESET	NRST	RESET
	4	+3V3	-	3.3V input/output
	5	+5V	-	5V output
	6	GND	-	Ground
	7	GND	-	Ground
	8	VIN	-	Power input
CN8 analog	1	A0	PA0	ADC1_0
	2	A1	PA1	ADC1_1
	3	A2	PA4	ADC1_4
	4	A3	PB0	ADC1_8
	5	A4	PC1 or PB9 ⁽¹⁾	ADC1_11 (PC1) or I2C1_SDA (PB9)
	6	A5	PC0 or PB8 ⁽¹⁾	ADC1_10 (PC0) or I2C1_SCL (PB8)
Right connectors				
CN5 digital	10	D15	PB8	I2C1_SCL
	9	D14	PB9	I2C1_SDA
	8	AREF	-	AVDD
	7	GND	-	Ground
	6	D13	PA5	SPI1_SCK
	5	D12	PA6	SPI1_MISO
	4	D11	PA7	TIM1_CH1N or SPI1_MOSI
	3	D10	PB6	TIM4_CH1 or SPI1_CS
	2	D9	PC7	TIM3_CH2
	1	D8	PA9	-
CN9 digital	8	D7	PA8	-
	7	D6	PB10	TIM2_CH3
	6	D5	PB4	TIM3_CH1
	5	D4	PB5	-
	4	D3	PB3	TIM2_CH2
	3	D2	PA10	-
	2	D1	PA2	USART2_TX
	1	D0	PA3	USART2_RX

1. Please refer to [Table 9: Solder bridges](#) for details.

Table 15. Arduino connectors on NUCLEO-L053R8

Connect or No.	Pin No.	Pin name	MCU pin	Function
Left connectors				
CN6 power	1	NC	-	-
	2	IOREF	-	3.3V Ref
	3	RESET	NRST	RESET
	4	+3V3	-	3.3V input/output
	5	+5V	-	5V output
	6	GND	-	Ground
	7	GND	-	Ground
	8	VIN	-	Power input
CN8 analog	1	A0	PA0	ADC_IN0
	2	A1	PA1	ADC_IN1
	3	A2	PA4	ADC_IN4
	4	A3	PB0	ADC_IN8
	5	A4	PC1 or PB9 ⁽¹⁾	ADC_IN11 (PC1) or I2C1_SDA (PB9)
	6	A5	PC0 or PB8 ⁽¹⁾	ADC_IN10 (PC0) or I2C1_SCL (PB8)
Right connectors				
CN5 digital	10	D15	PB8	I2C1_SCL
	9	D14	PB9	I2C1_SDA
	8	AREF	-	AVDD
	7	GND	-	Ground
	6	D13	PA5	SPI1_SCK
	5	D12	PA6	SPI1_MISO
	4	D11	PA7	TIM12_CH2 or SPI1_MOSI
	3	D10	PB6	SPI1_CS
	2	D9	PC7	TIM12_CH2
	1	D8	PA9	-

Table 15. Arduino connectors on NUCLEO-L053R8 (continued)

Connect or No.	Pin No.	Pin name	MCU pin	Function
CN9 digital	8	D7	PA8	-
	7	D6	PB10	TIM2_CH3
	6	D5	PB4	TIM12_CH1
	5	D4	PB5	-
	4	D3	PB3	TIM2_CH2
	3	D2	PA10	-
	2	D1	PA2	USART2_TX
1	D0	PA3	USART2_RX	

1. Please refer to [Table 9: Solder bridges](#) for details.

Warning: PWM is not supported by D10 on STM32L053 since the timer is not available on PB6.

Table 16. Arduino connectors on NUCLEO-L152RE

CN No.	Pin No.	Pin name	MCU pin	Function
Left connectors				
CN6 power	1	NC	-	-
	2	IOREF	-	3.3V Ref
	3	RESET	NRST	RESET
	4	+3V3	-	3.3V input/output
	5	+5V	-	5V output
	6	GND	-	Ground
	7	GND	-	Ground
CN8 analog	8	VIN	-	Power input
	1	A0	PA0	ADC_IN0
	2	A1	PA1	ADC_IN1
	3	A2	PA4	ADC_IN4
	4	A3	PB0	ADC_IN8
	5	A4	PC1 or PB9 ⁽¹⁾	ADC_IN11 (PC1) or I2C1_SDA (PB9)
6	A5	PC0 or PB8 ⁽¹⁾	ADC_IN10 (PC0) or I2C1_SCL (PB8)	

Table 16. Arduino connectors on NUCLEO-L152RE (continued)

CN No.	Pin No.	Pin name	MCU pin	Function
Right connectors				
CN5 digital	10	D15	PB8	I2C1_SCL
	9	D14	PB9	I2C1_SDA
	8	AREF	-	AVDD
	7	GND	-	Ground
	6	D13	PA5	SPI1_SCK
	5	D12	PA6	SPI1_MISO
	4	D11	PA7	TIM11_CH1 or SPI1_MOSI
	3	D10	PB6	TIM4_CH1 or SPI1_CS
	2	D9	PC7	TIM3_CH2
	1	D8	PA9	-
CN9 digital	8	D7	PA8	-
	7	D6	PB10	TIM2_CH3
	6	D5	PB4	TIM3_CH1
	5	D4	PB5	-
	4	D3	PB3	TIM2_CH2
	3	D2	PA10	-
	2	D1	PA2	USART2_TX
	1	D0	PA3	USART2_RX

1. Please refer to [Table 9: Solder bridges](#) for details.

5.12 STMicroelectronics Morpho connector

The STMicroelectronics Morpho connector consists in male pin headers (CN7 and CN10) accessible on both sides of the board. They can be used to connect the STM32 Nucleo board to an extension board or a prototype/wrapping board placed on top or on bottom side of the STM32 Nucleo board. All signals and power pins of the MCU are available on STMicroelectronics Morpho connector. This connector can also be probed by an oscilloscope, logical analyzer or voltmeter.

[Table 17](#) to [Table 22](#) show the pin assignment of each main MCU on STMicroelectronics Morpho connector.

Table 17. STMicroelectronics Morpho connector on NUCLEO-F030R8

CN7 odd pins		CN7 even pins		CN10 odd pins		CN10 even pins	
Pin No.	Name	Name	Pin No.	Pin No.	Name	Name	Pin No.
1	PC10	PC11	2	1	PC9	PC8	2
3	PC12	PD2	4	3	PB8	PC6	4
5	VDD	E5V	6	5	PB9	PC5	6
7	BOOT0 ⁽¹⁾	GND	8	7	AVDD	U5V ⁽²⁾	8
9	PF6	-	10	9	GND	-	10
11	PF7	IOREF	12	11	PA5	PA12	12
13	PA13 ⁽³⁾	RESET	14	13	PA6	PA11	14
15	PA14 ⁽³⁾	+3V3	16	15	PA7	PB12	16
17	PA15	+5V	18	17	PB6	PB11	18
19	GND	GND	20	19	PC7	GND	20
21	PB7	GND	22	21	PA9	PB2	22
23	PC13	VIN	24	23	PA8	PB1	24
25	PC14	-	26	25	PB10	PB15	26
27	PC15	PA0	28	27	PB4	PB14	28
29	PF0	PA1	30	29	PB5	PB13	30
31	PF1	PA4	32	31	PB3	AGND	32
33	VBAT	PB0	34	33	PA10	PC4	34
35	PC2	PC1 or PB9 ⁽⁴⁾	36	35	PA2	PF5	36
37	PC3	PC0 or PB8 ⁽⁴⁾	38	37	PA3	PF4	38

1. Default state of BOOT0 is 0. It can be set to 1 when a jumper is on pin5-7 of CN7. Two unused jumpers are available on CN11 and CN12 (bottom side of the board).
2. U5V is 5 V power from ST-LINK/V2-1 USB connector and it rises before +5V.
3. PA13 and PA14 share with SWD signals connected to ST-LINK/V2-1, it is not recommend to use them as IO pins if ST-LINK part is not cut.
4. Please refer to [Table 9: Solder bridges](#) for detail

**Table 18. STMicroelectronics Morpho connector on NUCLEO-F072RB,
NUCLEO-F334R8**

CN7 odd pins		CN7 even pins		CN10 odd pins		CN10 even pins	
Pin No.	Name	Name	Pin No.	Pin No.	Name	Name	Pin No.
1	PC10	PC11	2	1	PC9	PC8	2
3	PC12	PD2	4	3	PB8	PC6	4
5	VDD	E5V	6	5	PB9	PC5	6
7	BOOT0 ⁽¹⁾	GND	8	7	AVDD	U5V ⁽²⁾	8
9	-	-	10	9	GND	-	10
11	-	IOREF	12	11	PA5	PA12	12
13	PA13	RESET	14	13	PA6	PA11	14
15	PA14	+3V3	16	15	PA7	PB12	16
17	PA15	+5V	18	17	PB6	PB11	18
19	GND	GND	20	19	PC7	GND	20
21	PB7	GND	22	21	PA9	PB2	22
23	PC13 ⁽³⁾	VIN	24	23	PA8	PB1	24
25	PC14 ⁽³⁾	-	26	25	PB10	PB15	26
27	PC15	PA0	28	27	PB4	PB14	28
29	PF0	PA1	30	29	PB5	PB13	30
31	PF1	PA4	32	31	PB3	AGND	32
33	VBAT	PB0	34	33	PA10	PC4	34
35	PC2	PC1 or PB9 ⁽⁴⁾	36	35	PA2	-	36
37	PC3	PC0 or PB8 ⁽⁴⁾	38	37	PA3	-	38

1. Default state of BOOT0 is 0. It can be set to 1 when a jumper is on pin5-7 of CN7. Two unused jumpers are available on CN11 and CN12 (bottom side of the board).
2. U5V is 5 V power from ST-LINK/V2-1 USB connector and it rises before +5V
3. PA13 and PA14 share with SWD signals connected to ST-LINK/V2-1, it is not recommended to use them as IO pins if ST-LINK part is not cut.
4. Please refer to [Table 9: Solder bridges](#) for detail

Table 19. STMicroelectronics Morpho connector on NUCLEO-F103RB

CN7 odd pins		CN7 even pins		CN10 odd pins		CN10 even pins	
Pin No.	Name	Name	Pin No.	Pin No.	Name	Name	Pin No.
1	PC10	PC11	2	1	PC9	PC8	2
3	PC12	PD2	4	3	PB8	PC6	4
5	VDD	E5V	6	5	PB9	PC5	6
7	BOOT0 ⁽¹⁾	GND	8	7	AVDD	U5V ⁽²⁾	8
9	-	-	10	9	GND	-	10
11	-	IOREF	12	11	PA5	PA12	12
13	PA13 ⁽³⁾	RESET	14	13	PA6	PA11	14
15	PA14 ⁽³⁾	+3V3	16	15	PA7	PB12	16
17	PA15	+5V	18	17	PB6	PB11	18
19	GND	GND	20	19	PC7	GND	20
21	PB7	GND	22	21	PA9	PB2	22
23	PC13	VIN	24	23	PA8	PB1	24
25	PC14	-	26	25	PB10	PB15	26
27	PC15	PA0	28	27	PB4	PB14	28
29	PD0	PA1	30	29	PB5	PB13	30
31	PD1	PA4	32	31	PB3	AGND	32
33	VBAT	PB0	34	33	PA10	PC4	34
35	PC2	PC1 or PB9 ⁽⁴⁾	36	35	PA2	-	36
37	PC3	PC0 or PB8 ⁽⁴⁾	38	37	PA3	-	38

1. The default state of BOOT0 is 0. It can be set to 1 when a jumper is on pin5-7 of CN7. Two unused jumpers are available on CN11 and CN12 (bottom side of the board).
2. U5V is 5 V power from ST-LINK/V2-1 USB connector and it rises before +5 V
3. PA13 and PA14 share with SWD signals connected to ST-LINK/V2-1, it is not recommended to use them as IO pins if ST-LINK part is not cut.
4. Please refer to [Table 9: Solder bridges](#) for detail

Table 20. STMicroelectronics Morpho connector on NUCLEO-F302R8

CN7 odd pins		CN7 even pins		CN10 odd pins		CN10 even pins	
Pin No.	Name	Name	Pin No.	Pin No.	Name	Name	Pin No.
1	PC10	PC11	2	1	PC9	PC8	2
3	PC12	PD2	4	3	PB8	PC6	4
5	VDD	E5V	6	5	PB9	PC5	6
7	BOOT0 ⁽¹⁾	GND	8	7	AVDD	U5V ⁽²⁾	8
9	-	-	10	9	GND	-	10
11	-	IOREF	12	11	PB13	PA12	12
13	PA13 ⁽³⁾	RESET	14	13	PB14	PA11	14
15	PA14 ⁽³⁾	+3V3	16	15	PB15	PB12	16
17	PA15	+5V	18	17	PB6	PB11	18
19	GND	GND	20	19	PC7	GND	20
21	PB7	GND	22	21	PA9	PB2	22
23	PC13	VIN	24	23	PA8	PB1	24
25	PC14	-	26	25	PB10	PA7	26
27	PC15	PA0	28	27	PB4	PA6	28
29	PF0	PA1	30	29	PB5	PA5	30
31	PF1	PA4	32	31	PB3	AGND	32
33	VBAT	PB0	34	33	PA10	PC4	34
35	PC2	PC1 or PB9 ⁽⁴⁾	36	35	PA2	-	36
37	PC3	PC0 or PB8 ⁽⁴⁾	38	37	PA3	-	38

1. Default state of BOOT0 is 0. It can be set to 1 when a jumper is on pin5-7 of CN7. Two unused jumpers are available on CN11 and CN12 (bottom side of the board).
2. U5V is 5V power from ST-LINK/V2-1 USB connector and it rises before +5V.
3. PA13 and PA14 share with SWD signals connected to ST-LINK/V2-1, it is not recommend to use them as IO pins if ST-LINK part is not cut.
4. Please refer to [Table 9: Solder bridges](#) for details.

Table 21. STMicroelectronics Morpho connector on NUCLEO-F401RE, NUCLEO-F411RE

CN7 odd pins		CN7 even pins		CN10 odd pins		CN10 even pins	
Pin No.	Name	Name	Pin No.	Pin No.	Name	Name	Pin No.
1	PC10	PC11	2	1	PC9	PC8	2
3	PC12	PD2	4	3	PB8	PC6	4
5	VDD	E5V	6	5	PB9	PC5	6
7	BOOT0 ⁽¹⁾	GND	8	7	AVDD	U5V ⁽²⁾	8

Table 21. STMicroelectronics Morpho connector on NUCLEO-F401RE, NUCLEO-F411RE (continued)

CN7 odd pins		CN7 even pins		CN10 odd pins		CN10 even pins	
Pin No.	Name	Name	Pin No.	Pin No.	Name	Name	Pin No.
9	-	-	10	9	GND	-	10
11	-	IOREF	12	11	PA5	PA12	12
13	PA13 ⁽³⁾	RESET	14	13	PA6	PA11	14
15	PA14 ⁽³⁾	+3V3	16	15	PA7	PB12	16
17	PA15	+5V	18	17	PB6	-	18
19	GND	GND	20	19	PC7	GND	20
21	PB7	GND	22	21	PA9	PB2	22
23	PC13	VIN	24	23	PA8	PB1	24
25	PC14	-	26	25	PB10	PB15	26
27	PC15	PA0	28	27	PB4	PB14	28
29	PH0	PA1	30	29	PB5	PB13	30
31	PH1	PA4	32	31	PB3	AGND	32
33	VBAT	PB0	34	33	PA10	PC4	34
35	PC2	PC1 or PB9 ⁽⁴⁾	36	35	PA2	-	36
37	PC3	PC0 or PB8 ⁽⁴⁾	38	37	PA3	-	38

1. Default state of BOOT0 is 0. It can be set to 1 when a jumper is on pin5-7 of CN7. Two unused jumpers are available on CN11 and CN12 (bottom side of the board).
2. U5V is 5 V power from ST-LINK/V2-1 USB connector and it rises before +5V
3. PA13 and PA14 share with SWD signals connected to ST-LINK/V2-1, it is not recommend to use them as IO pins if ST-LINK part is not cut.
4. Please refer to [Table 9: Solder bridges](#) for detail

**Table 22. STMicroelectronics Morpho connector on NUCLEO-L152RE,
NUCLEO-L053R8**

CN7 odd pins		CN7 even pins		CN10 odd pins		CN10 even pins	
Pin No.	Name	Name	Pin No.	Pin No.	Name	Name	Pin No.
1	PC10	PC11	2	1	PC9	PC8	2
3	PC12	PD2	4	3	PB8	PC6	4
5	VDD	E5V	6	5	PB9	PC5	6
7	BOOT0 ⁽¹⁾	GND	8	7	AVDD	U5V ⁽²⁾	8
9	-	-	10	9	GND	-	10
11	-	IOREF	12	11	PA5	PA12	12
13	PA13 ⁽³⁾	RESET	14	13	PA6	PA11	14
15	PA14 ⁽³⁾	+3V3	16	15	PA7	PB12	16
17	PA15	+5V	18	17	PB6	PB11	18
19	GND	GND	20	19	PC7	GND	20
21	PB7	GND	22	21	PA9	PB2	22
23	PC13	VIN	24	23	PA8	PB1	24
25	PC14	-	26	25	PB10	PB15	26
27	PC15	PA0	28	27	PB4	PB14	28
29	PH0	PA1	30	29	PB5	PB13	30
31	PH1	PA4	32	31	PB3	AGND	32
33	VLCD	PB0	34	33	PA10	PC4	34
35	PC2	PC1 or PB9 ⁽⁴⁾	36	35	PA2	-	36
37	PC3	PC0 or PB8 ⁽⁴⁾	38	37	PA3	-	38

1. Default state of BOOT0 is 0. It can be set to 1 when a jumper is on pin5-7 of CN7. Two unused jumpers are available on CN11 and CN12 (bottom side of the board).
2. U5V is 5 V power from ST-LINK/V2-1 USB connector and it rises before +5V.
3. PA13 and PA14 share with SWD signals connected to ST-LINK/V2-1, it is not recommend to use them as IO pins if ST-LINK part is not cut.
4. Please refer to [Table 9: Solder bridges](#) for detail

6 Mechanical drawing

Figure 18. STM32 Nucleo board mechanical drawing

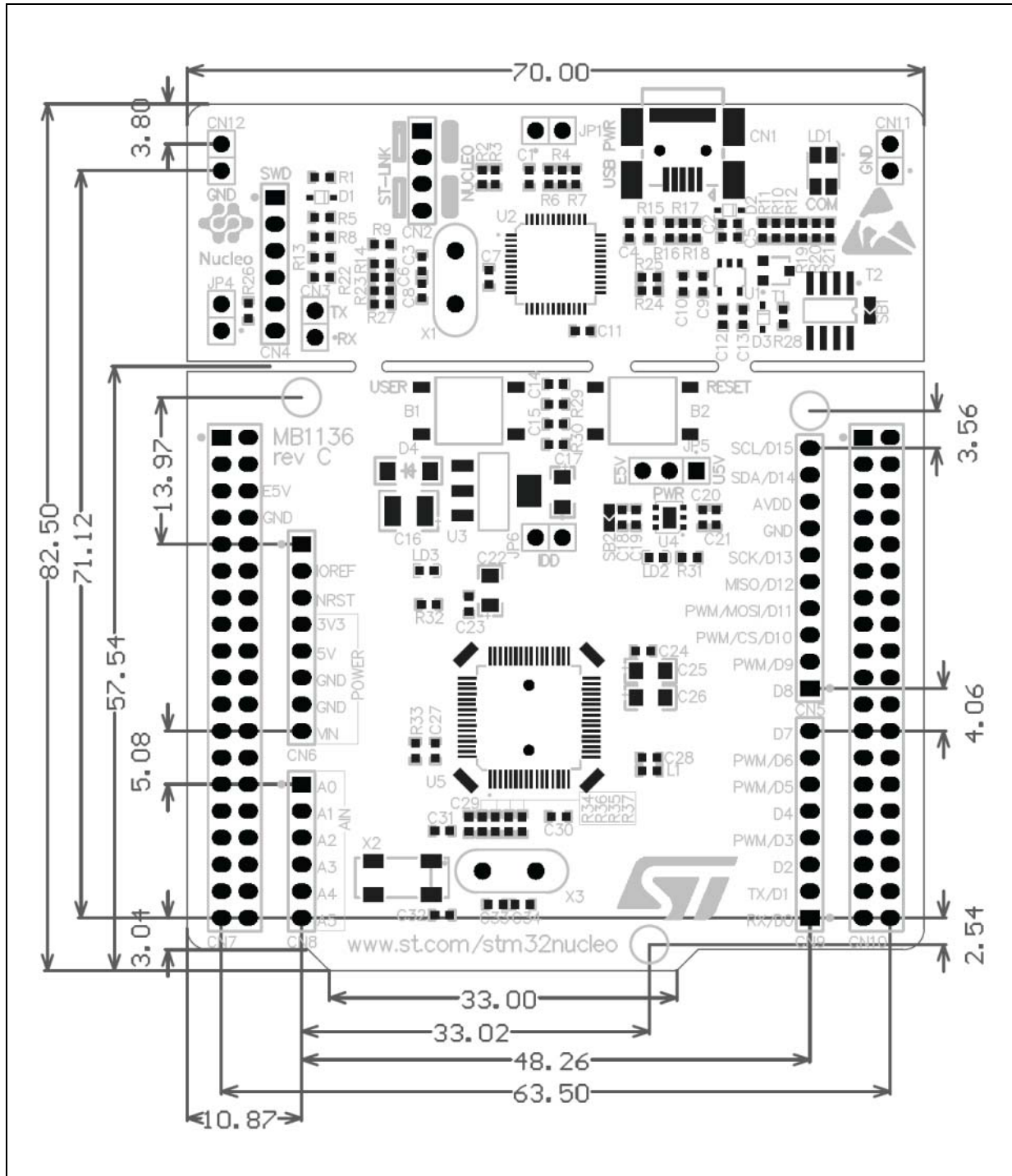

7 Electrical schematics

Figure 19 to Figure 22 show the electrical schematics of the STM32 Nucleo board.

Figure 19. Schematic (1/4)

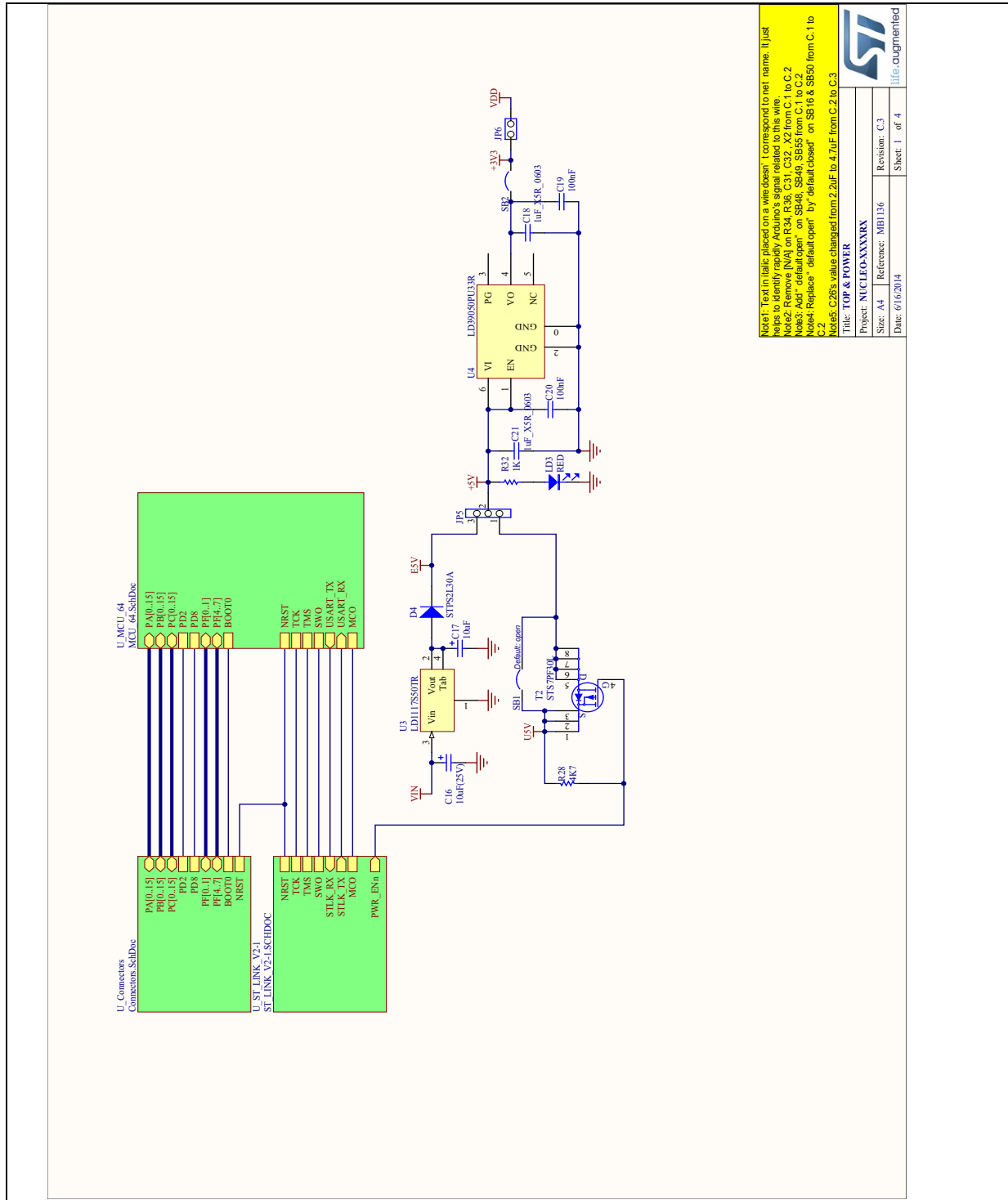

Note1: Text in italic placed on a wire doesn't correspond to net name. It just helps to identify rapidly Arduino's signal related to this wire.
 Note2: Remove [N/A] on R34, R36, C31, C32, X2 from C.1 to C.2
 Note3: Add "default:open" on SB48, SB49, SB55 from C.1 to C.2
 Note4: Replace "default:open" by "default:closed" on SB16 & SB59 from C.1 to C.2
 Note5: C26's value changed from 2.2µF to 4.7µF from C.2 to C.3

Title: TOP & POWER
 Project: NUCLEO-XXXXX
 Size: A4 Reference: MBI136 Revision: C.3
 Date: 6/16/2014 Sheet: 1 of 4 <http://www.st.com>

Figure 20. Schematic (2/4)

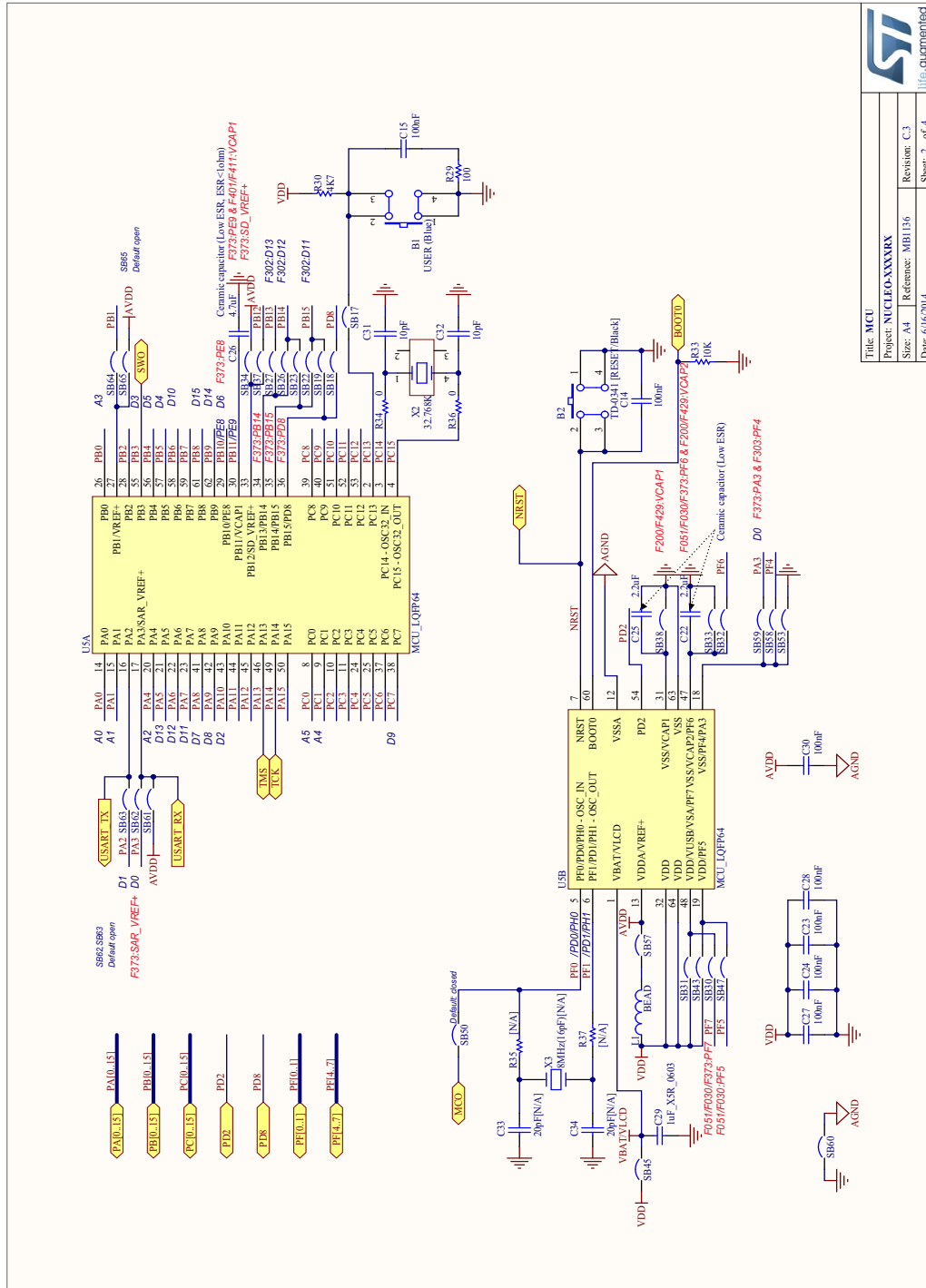

Title: MCU	
Project: NUCLEO-XXXXX	
Size: 144	Revision: C.3
Date: 6/16/2014	Reference: MBI136
Sheet 2 of 4	
life-augmented	



Figure 21. Schematic (3/4)

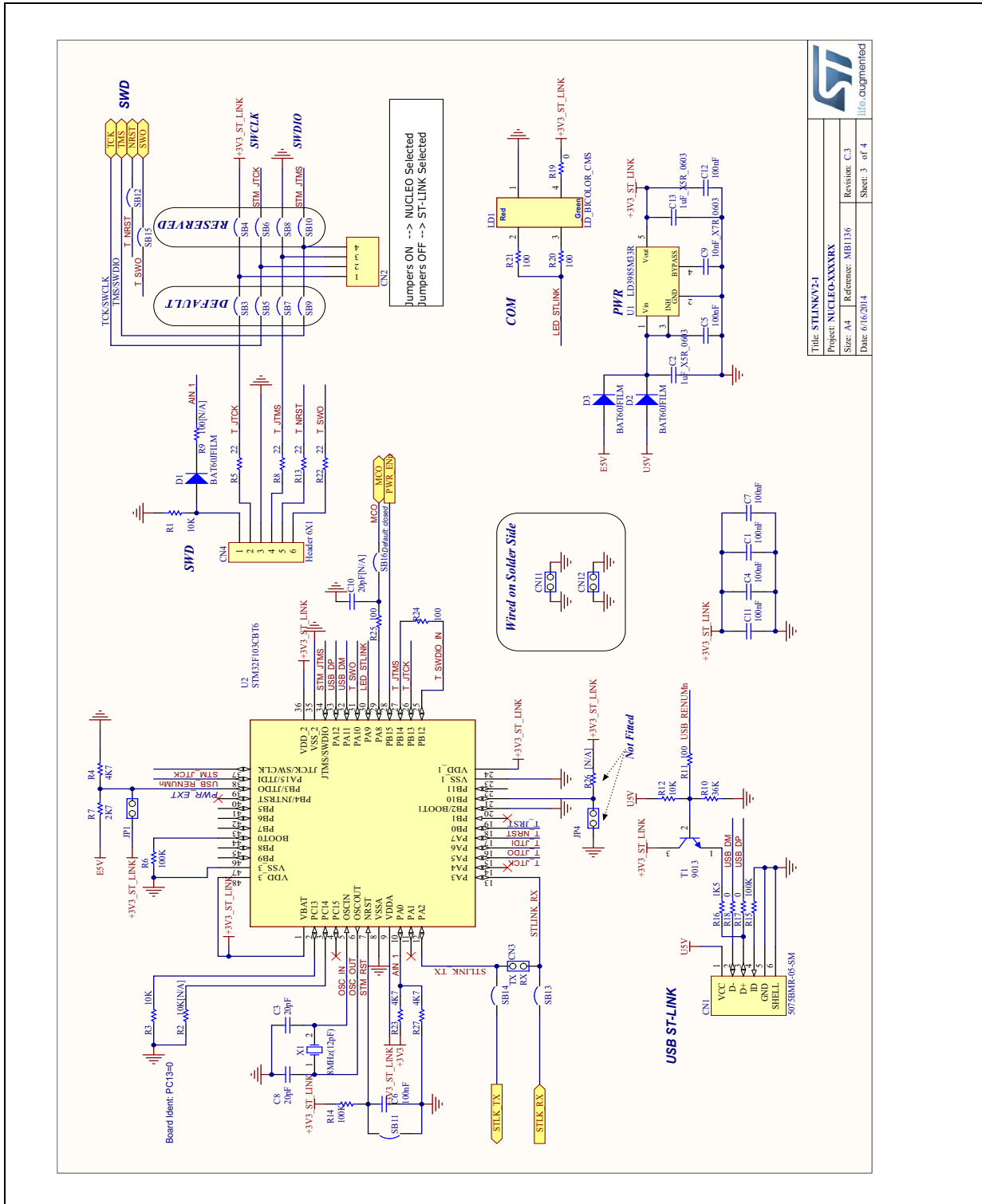

8 References

1. UM1075 - ST-LINK/V2 in-circuit debugger/programmer for STM8 and STM32, User manual

9 Revision history

Table 23. Document revision history

Date	Revision	Changes
10-Feb-2014	1	Initial release.
13-Feb-2014	2	Updated Figure 1 , Chapter 4 and Table 9 .
11-Apr-2014	3	Extended the applicability to NUCLEO-F302R8. Updated Table 1: Ordering information , Section 5.11: Arduino connectors and Section 5.12: STMicroelectronics Morpho connector . Updated Figure 1
10-June-2014	4	Updated the board figure: Figure 1 . Updated HSE and LSE configuration description: Section 5.7.1 , Section 4 and Section 5.7.2 . Extended the applicability to NUCLEO-F334R8, NUCLEO-F411RE and NUCLEO-L053R8.
20-June-2014	5	Updated the electrical schematics figures: Figure 19 , Figure 20 , Figure 21 and Figure 22 . Refer to the AN2867 for oscillator design guide for STM32 microcontrollers in Section 5.7.1: OSC clock supply and Section 5.7.2: OSC 32 kHz clock supply .

Please Read Carefully:

Information in this document is provided solely in connection with ST products. STMicroelectronics NV and its subsidiaries ("ST") reserve the right to make changes, corrections, modifications or improvements, to this document, and the products and services described herein at any time, without notice.

All ST products are sold pursuant to ST's terms and conditions of sale.

Purchasers are solely responsible for the choice, selection and use of the ST products and services described herein, and ST assumes no liability whatsoever relating to the choice, selection or use of the ST products and services described herein.

No license, express or implied, by estoppel or otherwise, to any intellectual property rights is granted under this document. If any part of this document refers to any third party products or services it shall not be deemed a license grant by ST for the use of such third party products or services, or any intellectual property contained therein or considered as a warranty covering the use in any manner whatsoever of such third party products or services or any intellectual property contained therein.

UNLESS OTHERWISE SET FORTH IN ST'S TERMS AND CONDITIONS OF SALE ST DISCLAIMS ANY EXPRESS OR IMPLIED WARRANTY WITH RESPECT TO THE USE AND/OR SALE OF ST PRODUCTS INCLUDING WITHOUT LIMITATION IMPLIED WARRANTIES OF MERCHANTABILITY, FITNESS FOR A PARTICULAR PURPOSE (AND THEIR EQUIVALENTS UNDER THE LAWS OF ANY JURISDICTION), OR INFRINGEMENT OF ANY PATENT, COPYRIGHT OR OTHER INTELLECTUAL PROPERTY RIGHT.

ST PRODUCTS ARE NOT DESIGNED OR AUTHORIZED FOR USE IN: (A) SAFETY CRITICAL APPLICATIONS SUCH AS LIFE SUPPORTING, ACTIVE IMPLANTED DEVICES OR SYSTEMS WITH PRODUCT FUNCTIONAL SAFETY REQUIREMENTS; (B) AERONAUTIC APPLICATIONS; (C) AUTOMOTIVE APPLICATIONS OR ENVIRONMENTS, AND/OR (D) AEROSPACE APPLICATIONS OR ENVIRONMENTS. WHERE ST PRODUCTS ARE NOT DESIGNED FOR SUCH USE, THE PURCHASER SHALL USE PRODUCTS AT PURCHASER'S SOLE RISK, EVEN IF ST HAS BEEN INFORMED IN WRITING OF SUCH USAGE, UNLESS A PRODUCT IS EXPRESSLY DESIGNATED BY ST AS BEING INTENDED FOR "AUTOMOTIVE, AUTOMOTIVE SAFETY OR MEDICAL" INDUSTRY DOMAINS ACCORDING TO ST PRODUCT DESIGN SPECIFICATIONS. PRODUCTS FORMALLY ESCC, QML OR JAN QUALIFIED ARE DEEMED SUITABLE FOR USE IN AEROSPACE BY THE CORRESPONDING GOVERNMENTAL AGENCY.

Resale of ST products with provisions different from the statements and/or technical features set forth in this document shall immediately void any warranty granted by ST for the ST product or service described herein and shall not create or extend in any manner whatsoever, any liability of ST.

ST and the ST logo are trademarks or registered trademarks of ST in various countries.

Information in this document supersedes and replaces all information previously supplied.

The ST logo is a registered trademark of STMicroelectronics. All other names are the property of their respective owners.

© 2014 STMicroelectronics - All rights reserved

STMicroelectronics group of companies

Australia - Belgium - Brazil - Canada - China - Czech Republic - Finland - France - Germany - Hong Kong - India - Israel - Italy - Japan - Malaysia - Malta - Morocco - Philippines - Singapore - Spain - Sweden - Switzerland - United Kingdom - United States of America

www.st.com