

Technical Data Sheet

Top View LEDs

45-21/KK2C-B3845AC4CB41/2T

Features

- Top view white LEDs
- White SMT package.
- Lead frame package with individual 2 pins.
- Wide viewing angle.
- Soldering methods: IR reflow soldering.
- Pb-free.
- The product itself will remain within RoHS compliant version.

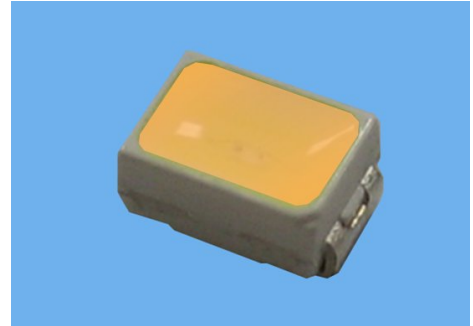

Descriptions

- Due to the package design, 45-21 has wide viewing angle, low power consumption and white LEDs are devices which are materialized by combing Blue LEDs and special phosphors. This feature makes the LED ideal for light guide application.

Applications

- General lighting.
- Decorative and Entertainment Lighting
- Indicators.
- Illuminations.
- Switch lights.

Device Selection Guide

Chip	Emitted Color	Resin Color
Material		
InGaN	White	Water Clear

Technical Data Sheet

Top View LEDs

45-21/KK2C-B3845AC4CB41/2T

Package Outline Dimensions

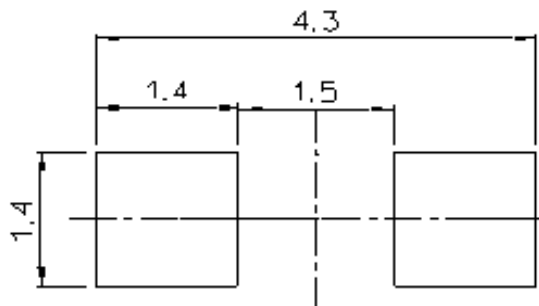
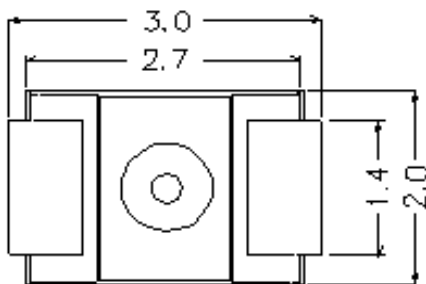
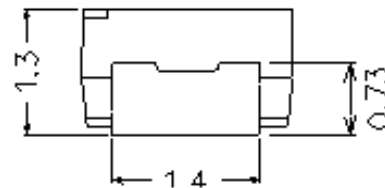
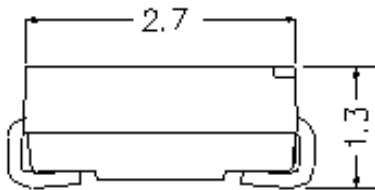
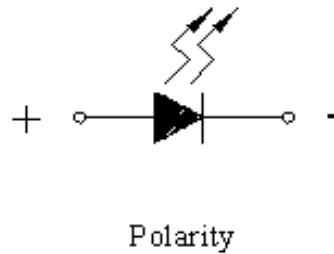
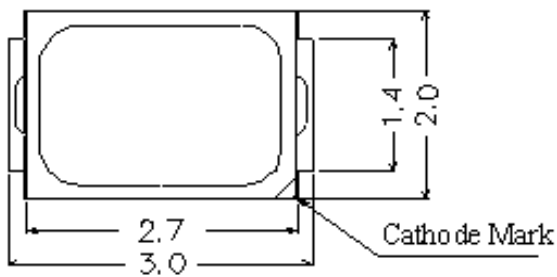

Recommended soldering pad design

Note: Tolerances unless mentioned is $\pm 0.1\text{mm}$; Unit = mm

Technical Data Sheet

Top View LEDs

45-21/KK2C-B3845AC4CB41/2T

Absolute Maximum Ratings (Ta=25)

Parameter	Symbol	Rating	Unit
Reverse Voltage	V _R	5	V
Forward Current	I _F	30	mA
Peak Forward Current (Duty 1/10 @1KHz)	I _{FP}	100	mA
Power Dissipation	P _d	110	mW
Electrostatic Discharge(HBM)	ESD	1000	V
Operating Temperature	Topr	-40 ~ +85	
Storage Temperature	Tstg	-40 ~ +90	
Soldering Temperature	Tsol	Reflow Soldering: 260 for 10 sec. Hand Soldering : 350 for 3 sec.	

Note: The products are sensitive to static electricity and must be carefully taken when handling products.

Electro-Optical Characteristics (Ta=25)

Parameter	Symbol	Min.	Typ.	Max.	Unit	Condition
Luminous Intensity	I _V	1800	-----	2400	mcd	I _F =20mA
Viewing Angle	2θ _{1/2}	---	120	---	deg	I _F =20mA
Forward Voltage	V _F	2.9	-----	3.4	V	I _F =20mA
Reverse Current	I _R	---	---	50	μA	V _R =5V
Color Rendering Index	Ra	80	----	----	----	I _F =20mA

Notes:

1. Tolerance of Luminous Intensity: ±11%
2. Tolerance of Forward Voltage: ±0.05V
3. Tolerance Color Rendering Index : ± 2

Technical Data Sheet**Top View LEDs****45-21/KK2C-B3845AC4CB41/2T****Bin Range of Luminous Intensity**

Bin Code	Min.	Max.	Unit	Conduction
AC	1800	2000	mcd	I _F =20mA
2C	2000	2200		
4C	2200	2400		

Bin Range of Forward Voltage

Group	Bin Code	Min.	Max.	Unit	Condition
B41	36	2.9	3.0	V	I _F =20mA
	37	3.0	3.1		
	38	3.1	3.2		
	39	3.2	3.3		
	40	3.3	3.4		

Notes:

1. Tolerance of Luminous Intensity: $\pm 11\%$
2. Tolerance of Forward Voltage: $\pm 0.05V$

Technical Data Sheet

Top View LEDs

45-21/KK2C-B3845AC4CB41/2T

Bin Range of Chromaticity Coordinates($I_F = 20\text{mA}$)

CCT	Bin Code	CIE_x	CIE_y	Bin Code	CIE_x	CIE_y
3800K ~ 4500K	T5	0.3642	0.3829	S5	0.3811	0.3937
		0.3811	0.3937		0.3963	0.4035
		0.3783	0.3825		0.3924	0.3909
		0.3622	0.3716		0.3783	0.3825
	T6	0.3622	0.3716	S6	0.3783	0.3825
		0.3783	0.3825		0.3924	0.3909
		0.3741	0.3658		0.3871	0.3739
		0.3594	0.3557		0.3741	0.3658

Note: Tolerance of Chromaticity Coordinates: ± 0.01

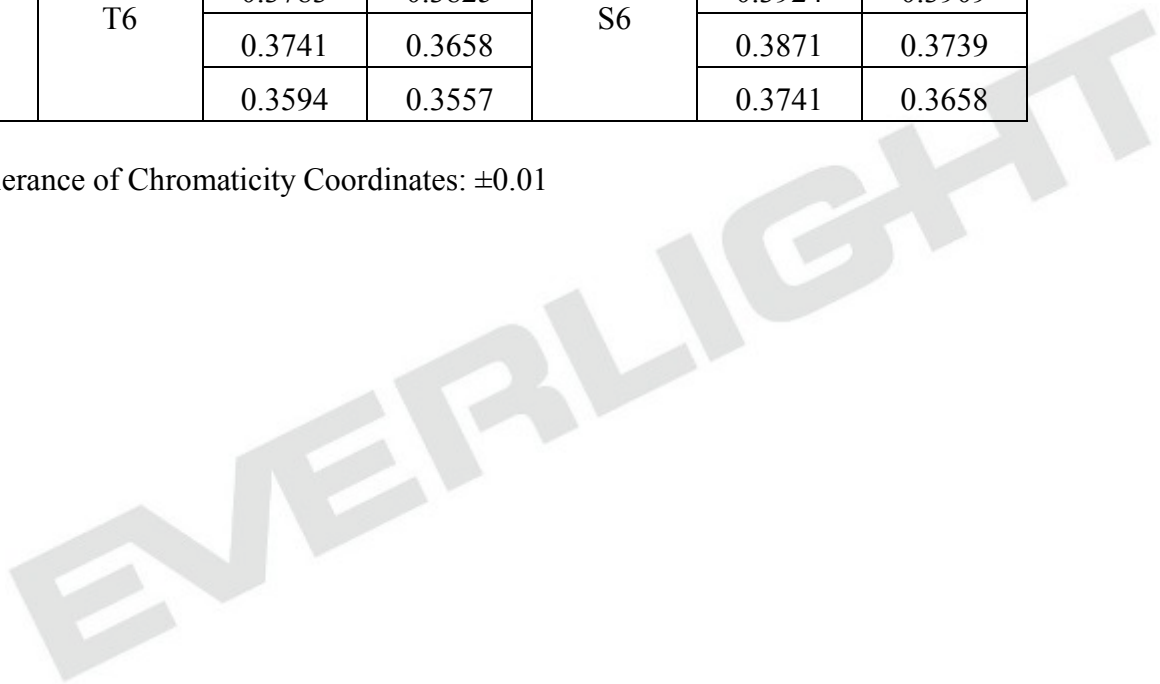

Technical Data Sheet

Top View LEDs

45-21/KK2C-B3845AC4CB41/2T

The C.I.E. 1931 Chromaticity Diagram

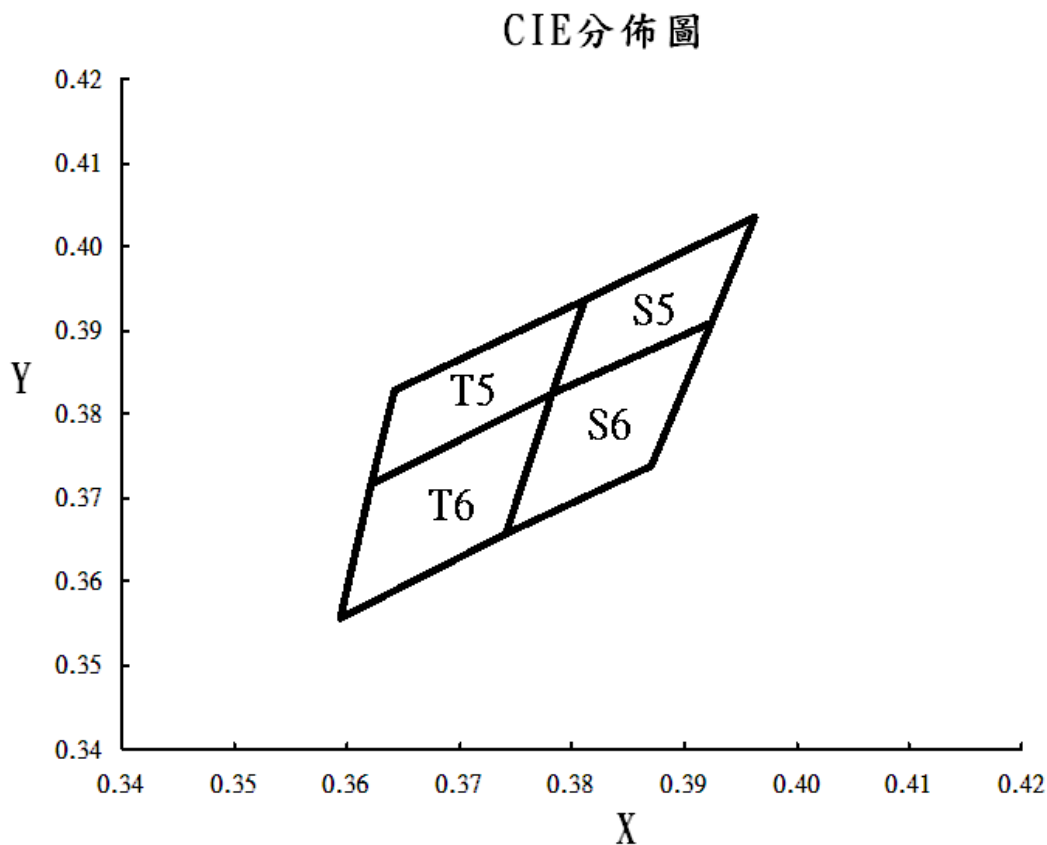

Technical Data Sheet

Top View LEDs

45-21/KK2C-B3845AC4CB41/2T

Typical Electro-Optical Characteristics Curves

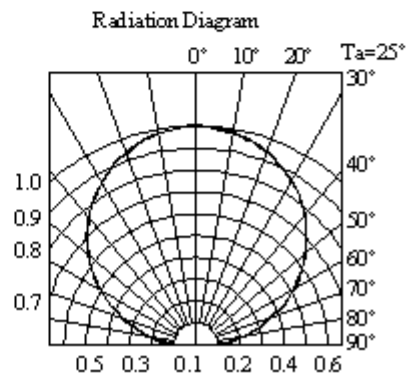
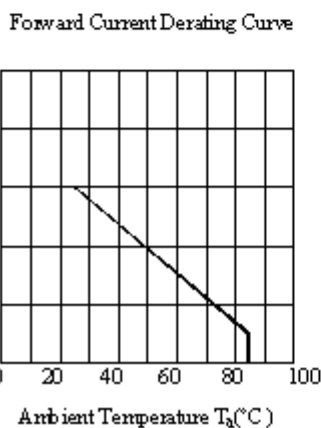
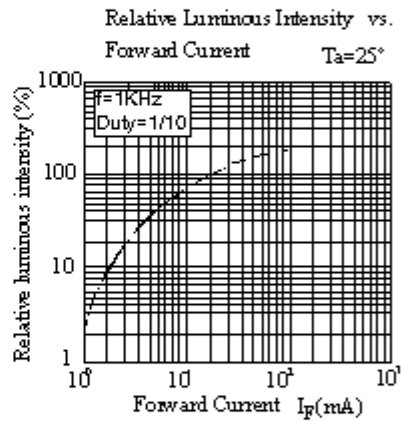
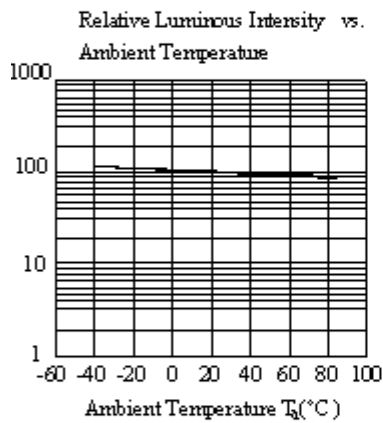
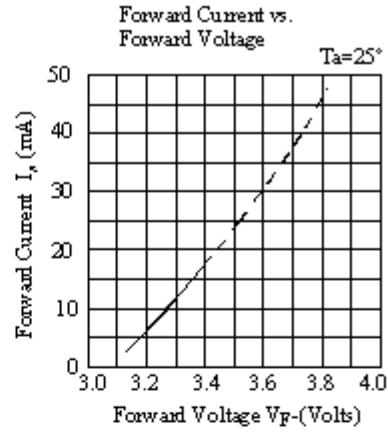
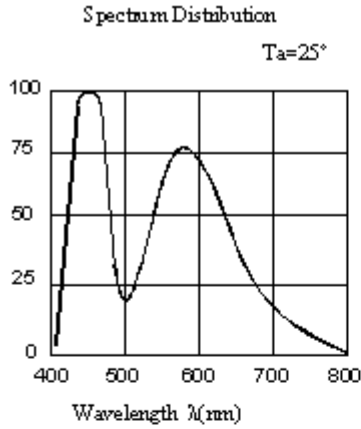

Technical Data Sheet

Top View LEDs

45-21/KK2C-B3845AC4CB41/2T

Label Explanation

CAT: Luminous Intensity Rank

HUE: Chromaticity Coordinates

REF: Forward Voltage Rank



Reel Dimensions

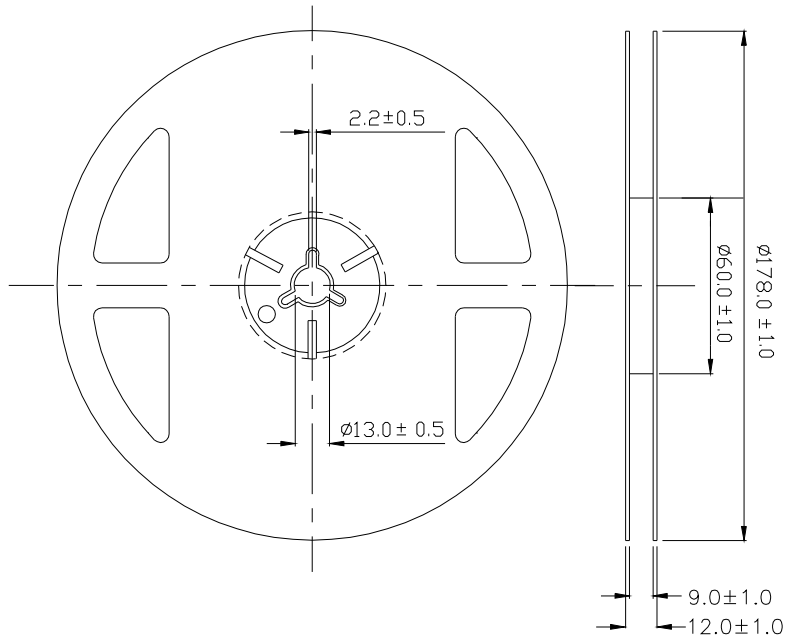

Note: Tolerance unless mentioned is ± 0.1 mm; Unit = mm

Technical Data Sheet

Top View LEDs

45-21/KK2C-B3845AC4CB41/2T

Carrier Tape Dimensions: Loaded Quantity 2000 pcs Per Reel

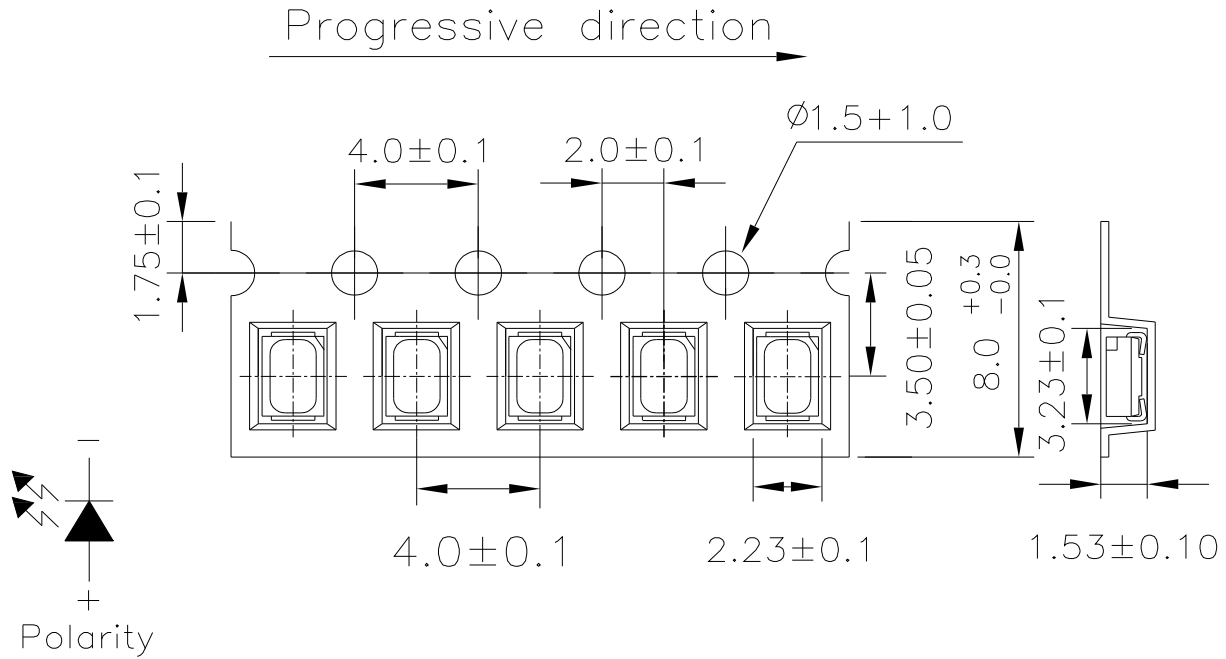

Note: Tolerance unless mentioned is ± 0.1 mm; Unit = mm

Moisture Resistant Packaging

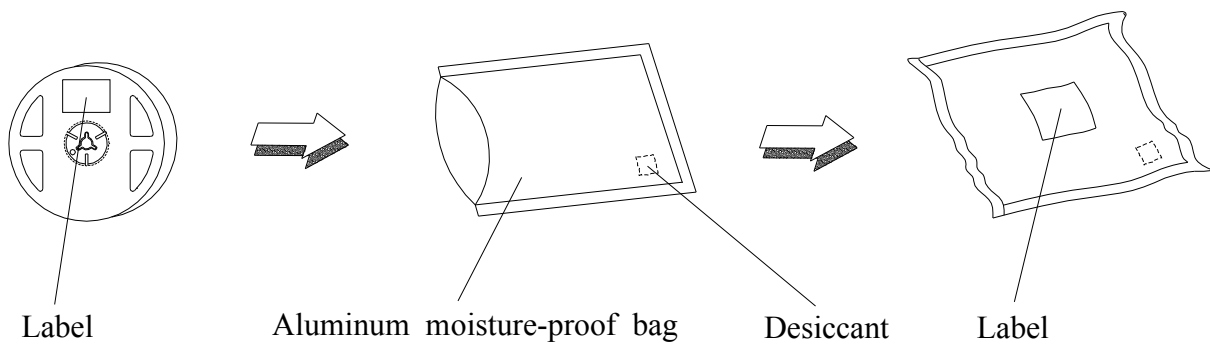

Technical Data Sheet

Top View LEDs

45-21/KK2C-B3845AC4CB41/2T

Reliability Test Items and Conditions

The reliability of products shall be satisfied with items listed below.

Confidence level : 90%

LTPD : 10%

No.	Items	Test Condition	Test Hours/Cycles	Sample Size	Ac/Re
1	Reflow Soldering	Temp. : 260 ±5 Min. 10 sec.	6 Min.	22 PCS	0/1
2	Temperature Cycle	H : +100 15min ↓ 5 min L : -40 15min	300 Cycles	22 PCS.	0/1
3	Thermal Shock	H : +100 5min ↓ 10 sec L : -10 5min	300 Cycles	22 PCS.	0/1
4	High Temperature Storage	Temp. : 100	1000 Hrs.	22 PCS.	0/1
5	Low Temperature Storage	Temp. : -40	1000 Hrs.	22 PCS.	0/1
6	DC Operating Life	I _F = 20 mA / 25	1000 Hrs.	22 PCS.	0/1
7	High Temperature / High Humidity	85 /85%RH	1000 Hrs.	22 PCS.	0/1

Technical Data Sheet

Top View LEDs

45-21/KK2C-B3845AC4CB41/2T

Precautions for Use

1. Over-current-proof

Customer must apply resistors for protection; otherwise slight voltage shift will cause big current change (Burn out will happen).

2. Storage

2.1 Do not open moisture proof bag before the products are ready to use.

2.2 Before opening the package: The LEDs should be used within one year and kept at 30 or less and 70%RH or less.

2.3 After opening the package: We recommend that the LED should be soldered quickly (within 3 days).The soldering condition is 30 or less and 60% RH or less. If unused LEDs remain, it should be stored in moisture proof packages.

2.4 If the moisture absorbent material (silica gel) has faded away or the LEDs have exceeded the storage time, baking treatment should be performed using the following conditions.

Baking treatment: 60±5 for 24 hours.(One time only)

3. Soldering Condition

3.1 Pb-free solder temperature profile

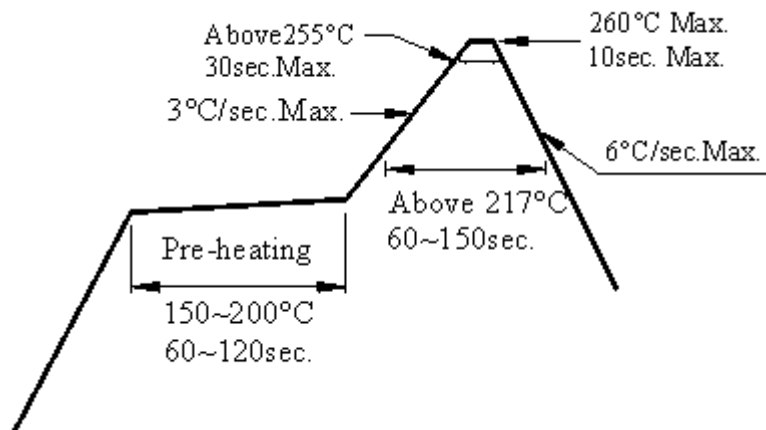

3.2 Reflow soldering should not be done more than two times.

3.3 When soldering, do not put stress on the LEDs during heating.

3.4 After soldering, do not warp the circuit board.

Technical Data Sheet

Top View LEDs

45-21/KK2C-B3845AC4CB41/2T

4. Soldering Iron

Each terminal is to go to the tip of soldering iron temperature less than 350 for 3 seconds within once in less than the soldering iron capacity 25W. Leave two seconds and more intervals, and do soldering of each terminal. Be careful because the damage of the product is often started at the time of the hand solder.

5. Repairing

Repair should not be done after the LEDs have been soldered. When repairing is unavoidable, a double-head soldering iron should be used (as below figure). It should be confirmed beforehand whether the characteristics of the LEDs will or will not be damaged by repairing.

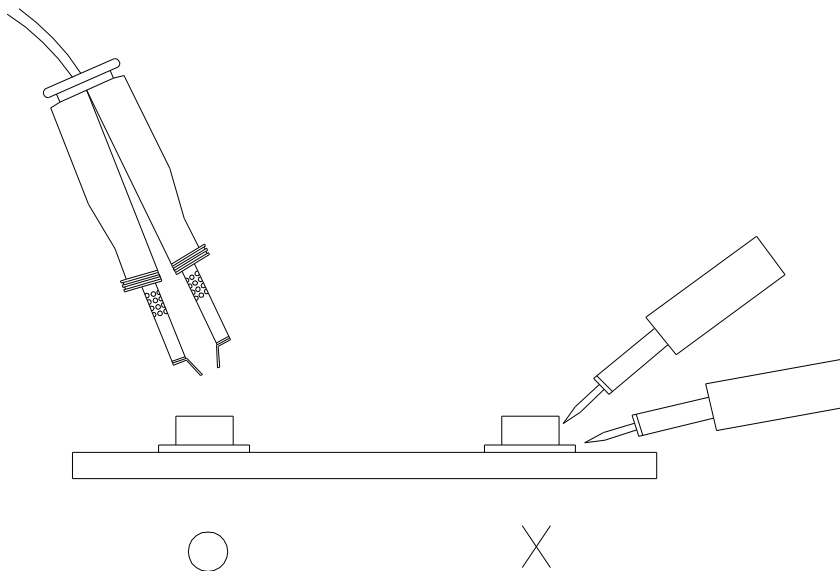

EVERLIGHT ELECTRONICS CO., LTD.
Office: No 25, Lane 76, Sec 3, Chung Yang Rd,
Tucheng, Taipei 236, Taiwan, R.O.C

Tel: 886-2-2267-2000, 2267-9936
Fax: 886-2267-6244, 2267-6189, 2267-6306
<http://www.everlight.com>