

Specification

Part No.	:	GW.48.A151
Product Name	:	Black 2.4 / 5.8GHz Dual Band 3-3.5dBi Rubber Duck Dipole Antenna with RP-SMA(M)
Features	:	2.4/5.8GHz Dual Band Operation UV Resistant, Robust TPEE Housing IP65 Waterproof Enclosure IK05 Impact Rated Enclosure 3.5 dBi Peak Gain @ 2.4GHz 3 dBi Peak Gain @ 5.8GHz Connector Mount: RP-SMA(M) Dimensions: 89.5mm x 7.5mm Diameter RoHS & REACH compliant



1. Introduction

The GW.48 dual-band 2.4/5.8GHz RP-SMA(M) mount dipole antenna is designed for superior performance and reliability. With an omnidirectional radiation pattern and excellent efficiency and gain on both 2.4 GHz and 5.8 GHz bands.

At just 89.5mm in height, the GW.48 is a great smaller form factor solution for Bluetooth and Wireless LAN networks. The IP67 rated enclosure makes it suitable for both indoor and outdoor applications. The flexible IK05 rated TPEE enclosure is impact resistant and durable and has the added benefit of UV resistance, allowing it to meet the needs of demanding outdoor applications.

The GW.48 has a 3.5 dBi Peak Gain at 2.4GHz and 3 dBi Peak Gain @ 5.8GHz making it a cost-effective, high-performing choice for any outdoor application operating at 2.4 or 5.8 GHz. Many module manufacturers specify peak gain limits for any antennas that are to be connected to that module. Those peak gain limits are based on free-space conditions. In practice, the peak gain of an antenna tested in free-space can degrade by at least 1 or 2dBi when installed. So ideally you should go for a slightly higher peak gain antenna than mentioned on the module specification to compensate for this effect, giving you better performance.

Upon testing of any of our antennas with your device and a selection of appropriate layout, integration technique, or cable, Taoglas can make sure any of our antennas' peak gain will be below the peak gain limits. Taoglas can then issue a specification and/or report for the selected antenna in your device that will clearly show it complying with the peak gain limits, so you can be assured you are meeting regulatory requirements for that module.

Choosing a Taoglas antenna with a higher peak gain than what is specified by the module manufacturer and enlisting our help will ensure you are getting the best performance possible without exceeding the peak gain limits.

Contact your regional Taoglas customer support team for further information.

2. Specification

ELECTRICAL			
Frequency	2.4 ~ 2.5GHz	5.15 ~ 5.85GHz	
Return Loss (dB)	<-10	<-7	
Peak Gain (dBi)	Free Space	3.42	4.56
	Ground Plane	2.52	2.85
Average Gain (dBi)	Free Space	-1.20	-1.73
	Ground Plane	-1.56	-2.62
Efficiency (%)	Free Space	75.82	67.21
	Ground Plane	69.77	54.65
Polarization	Linear		
Impedance	50 Ω		
Radiation Pattern	Omni		
Input Power	2W max.		
MECHANICAL			
Antenna Length	89.5 mm		
Antenna Diameter	7.5 mm		
Weight	9.5g		
Antenna Body Material	TPEE		
Connector	RP-SMA(M)		
Waterproof	IP65		
Pendulum Hammer Test [IEC62262]	IK05		
ENVIRONMENTAL			
Temperature Range	-40°C to 85°C		
Humidity	Non-condensing 65°C 95% RH		

3. Antenna Measurement Setup & Return Loss

3.1 Test Setup

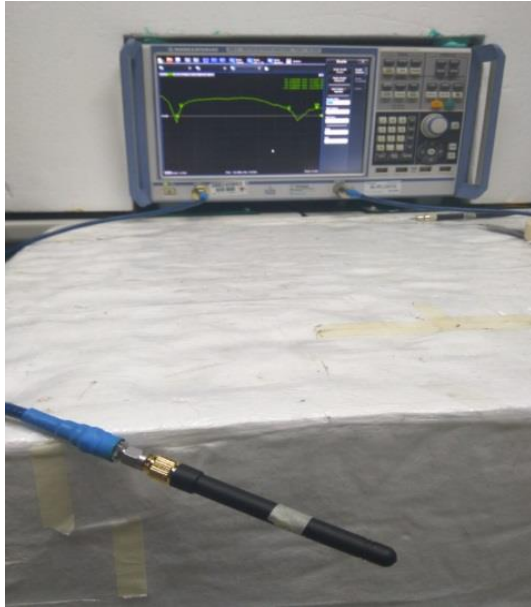

Free Space

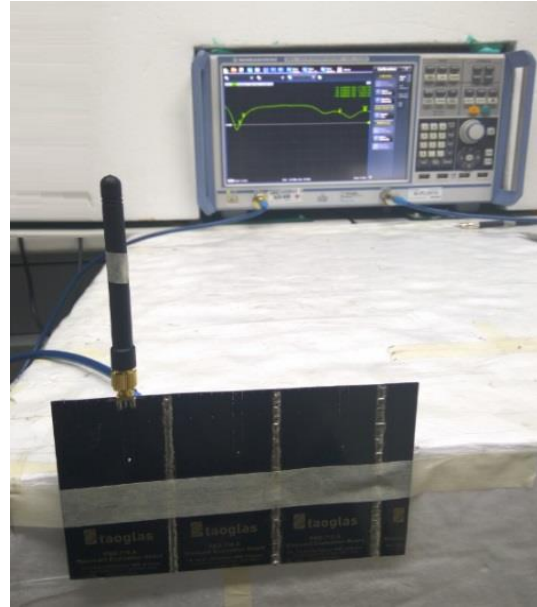

With Ground Plane

3.2 Return Loss

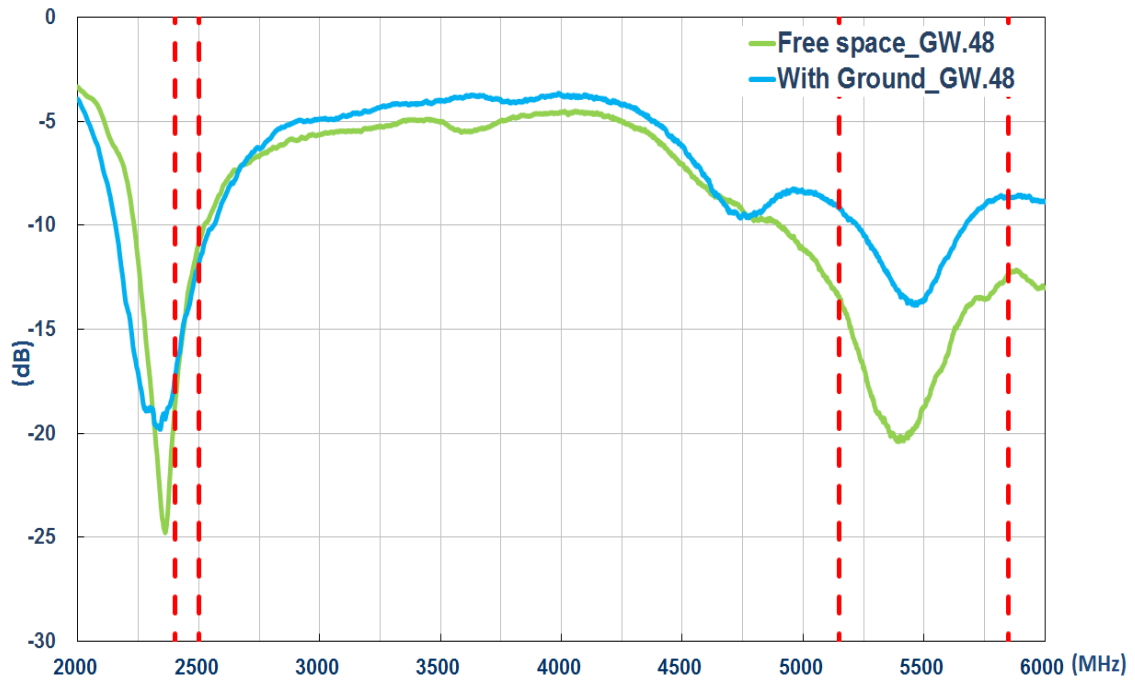

3.2. Efficiency

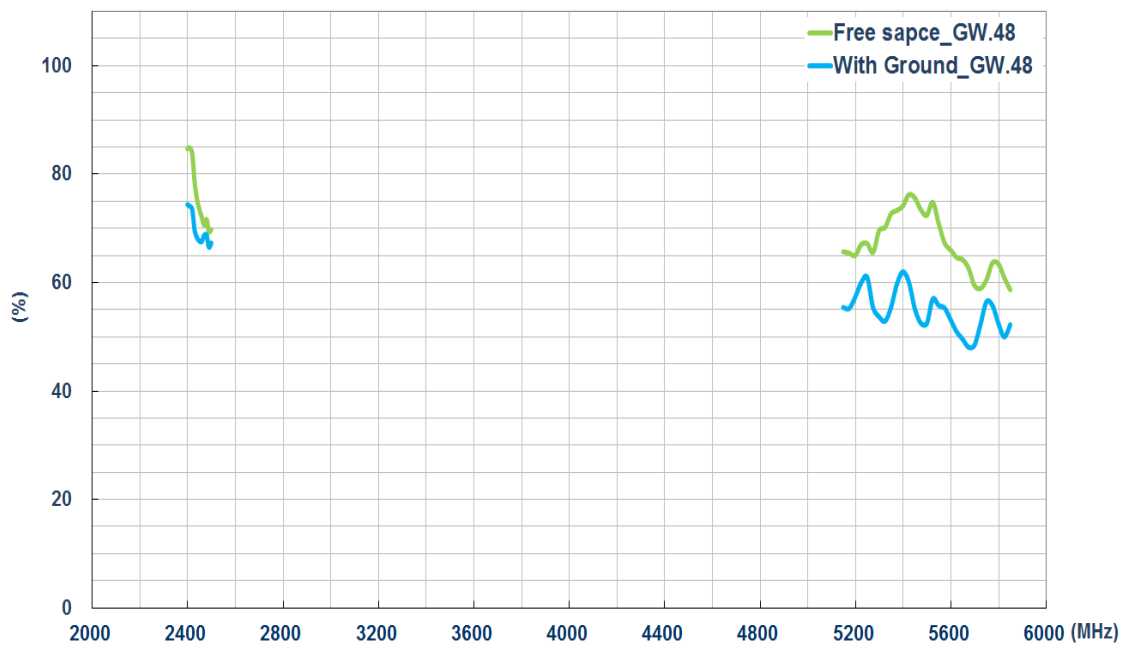

3.3 Average Gain

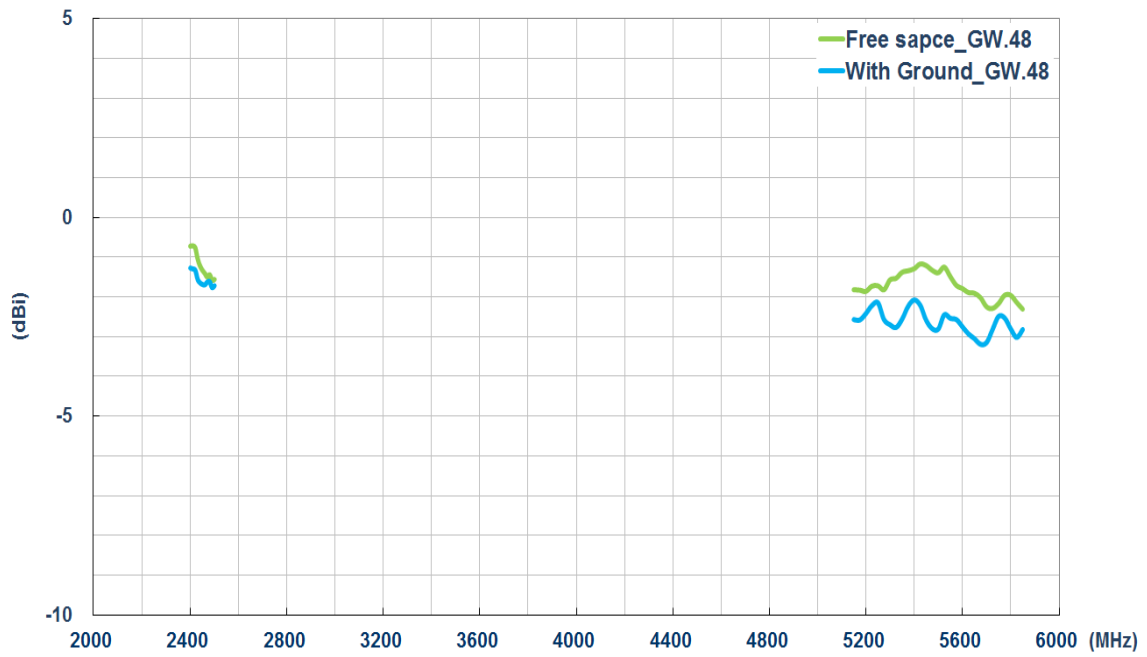

3.4 Peak Gain

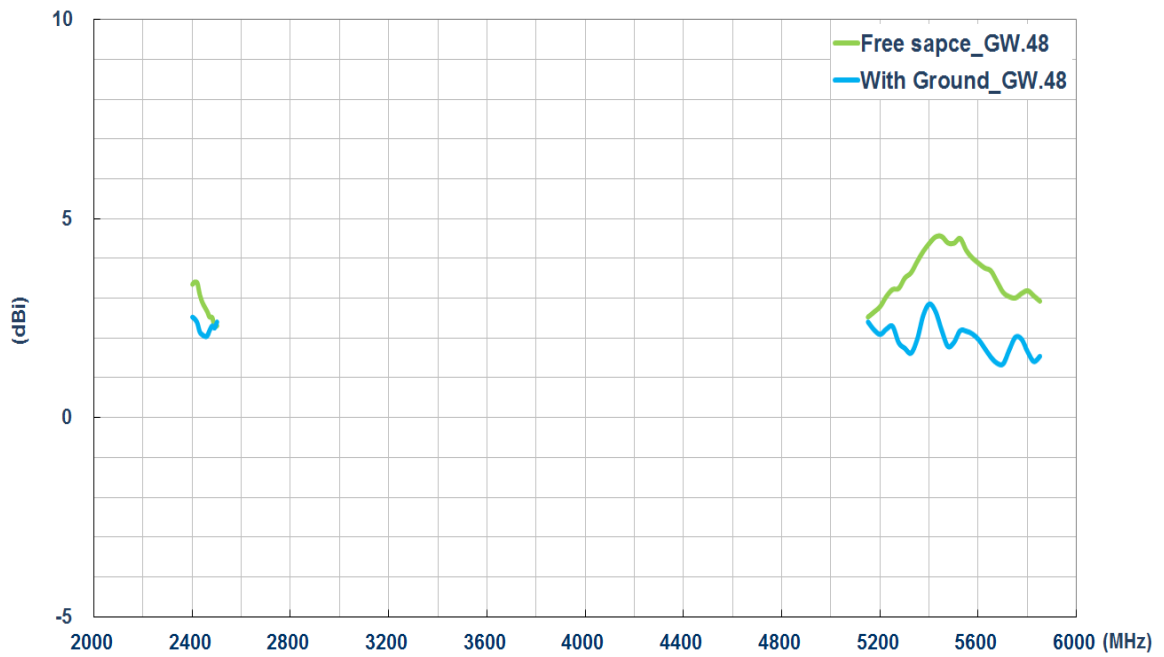

4. Antenna Radiation Patterns

4.1 Antenna Setup (Antenna Test Setup in Anechoic Chamber)



Free Space

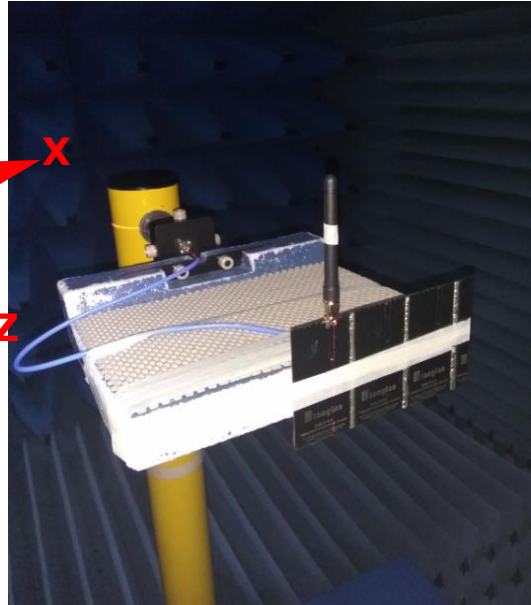

With Ground

4.2 2D Radiation Patterns

4.2.1 Wi-Fi Dual Band - Free Space

XY Plane

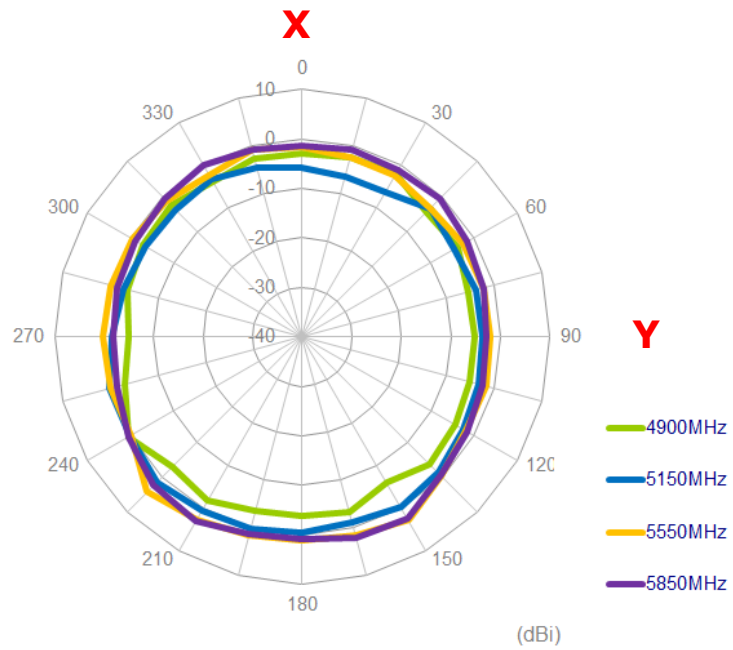
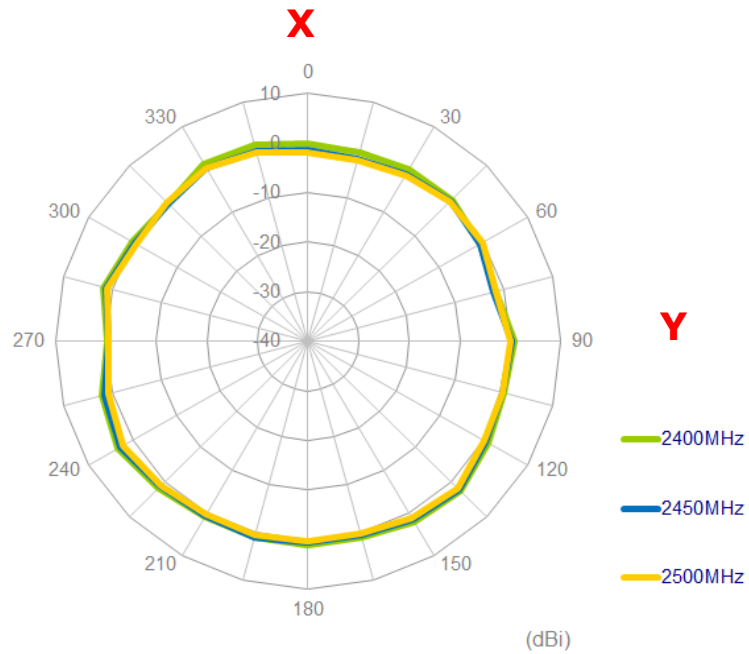

XZ Plane

Z

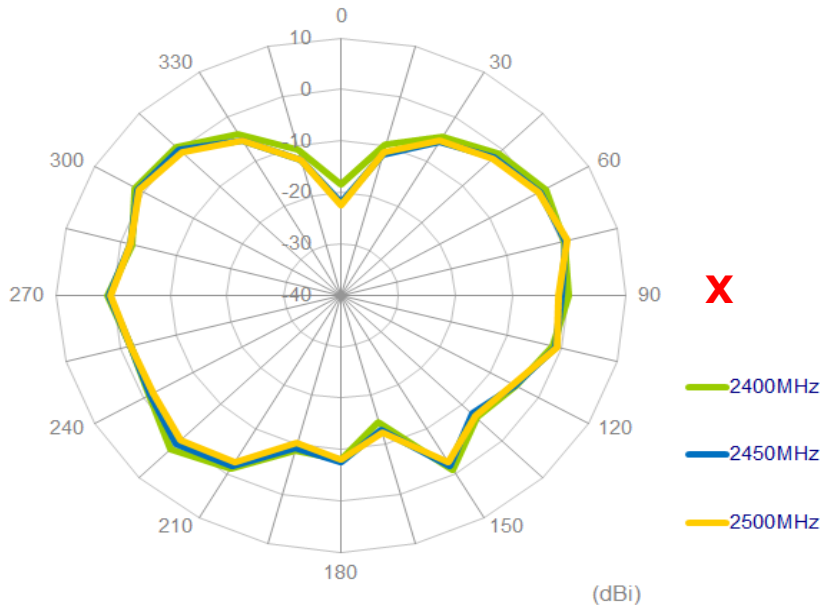

Z

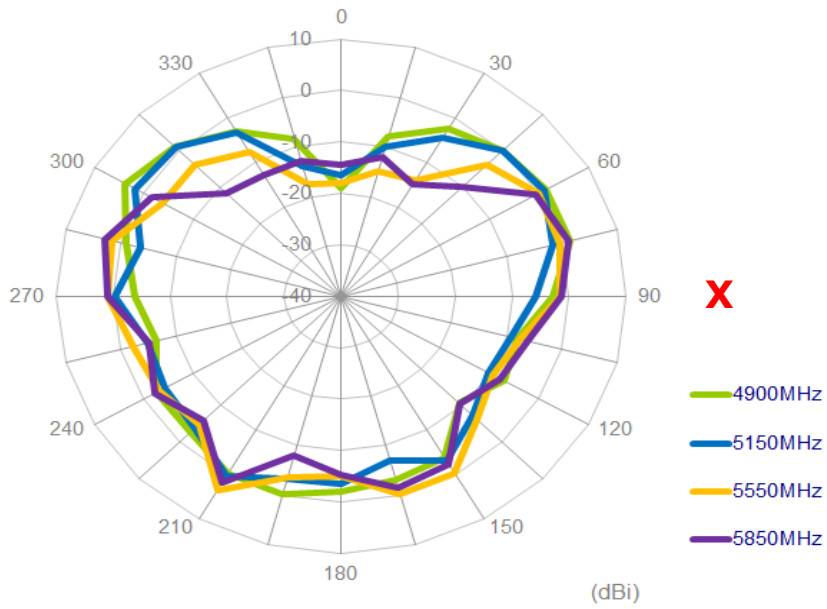

YZ Plane

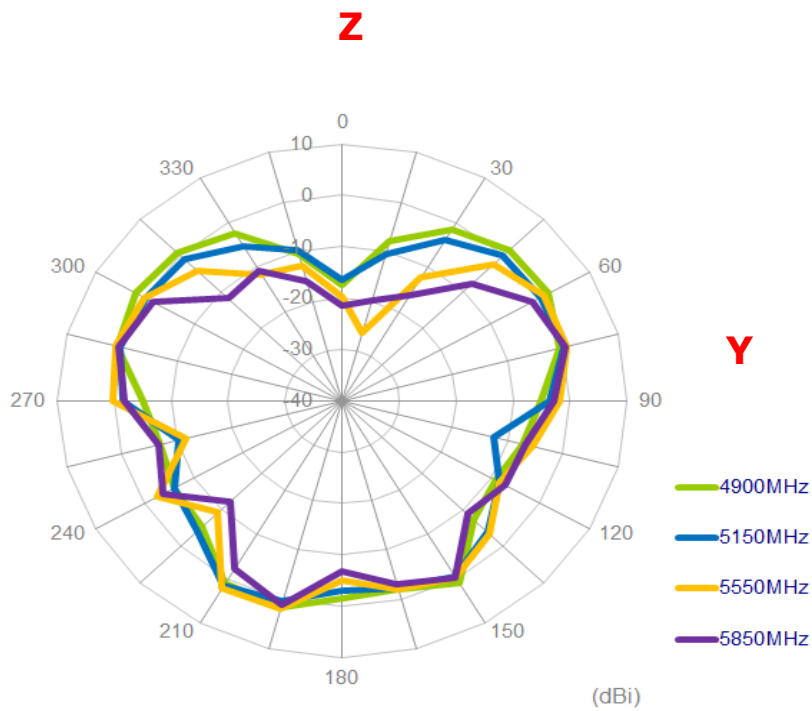
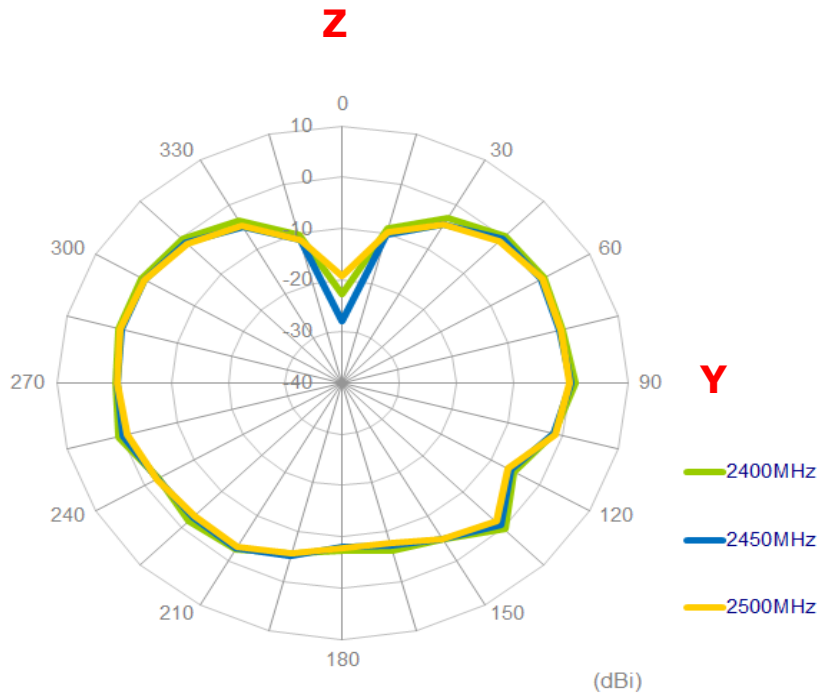

4.2.2 Wi-Fi Dual Band (With Ground)

XY Plane

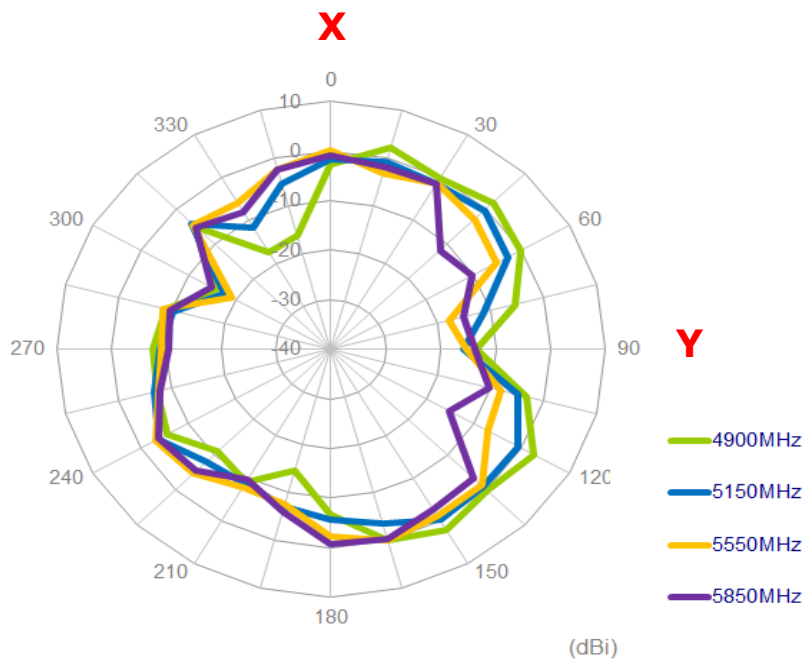
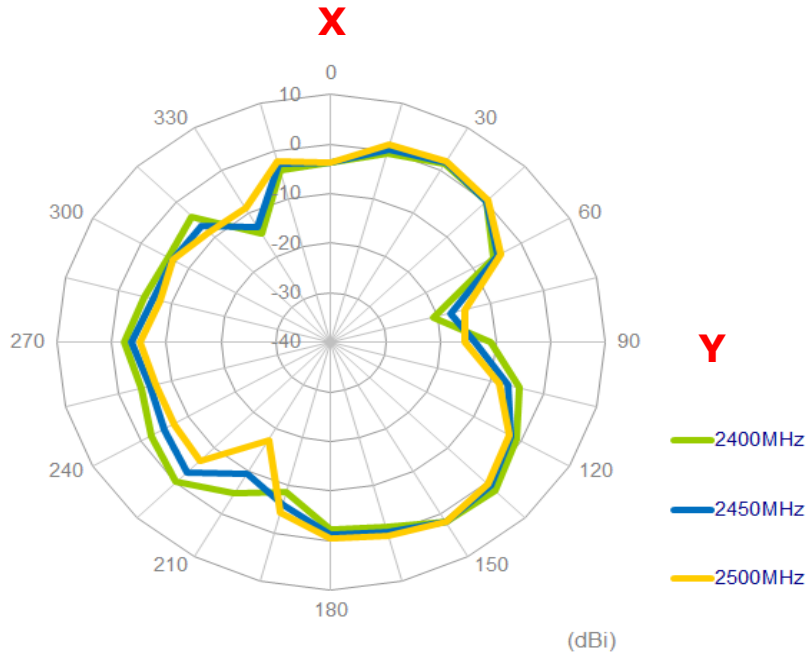

XZ Plane

Z

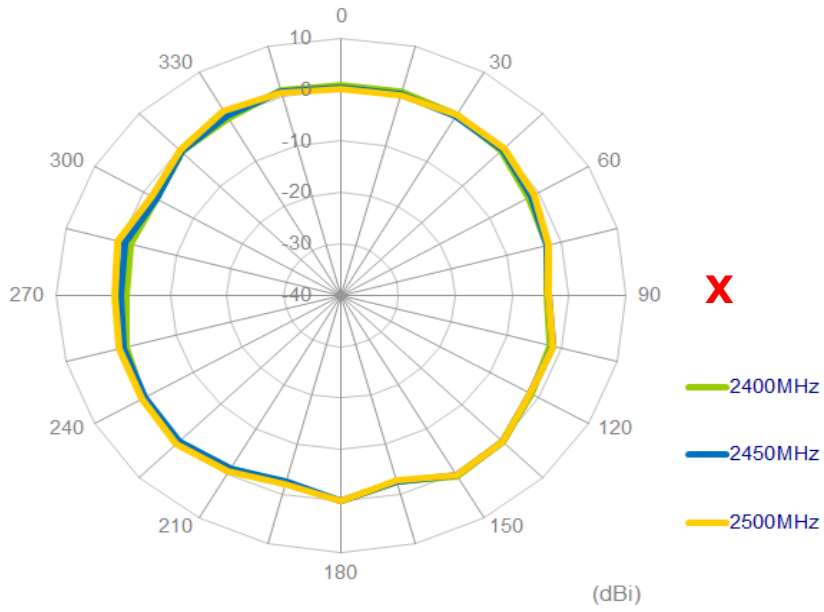

Z

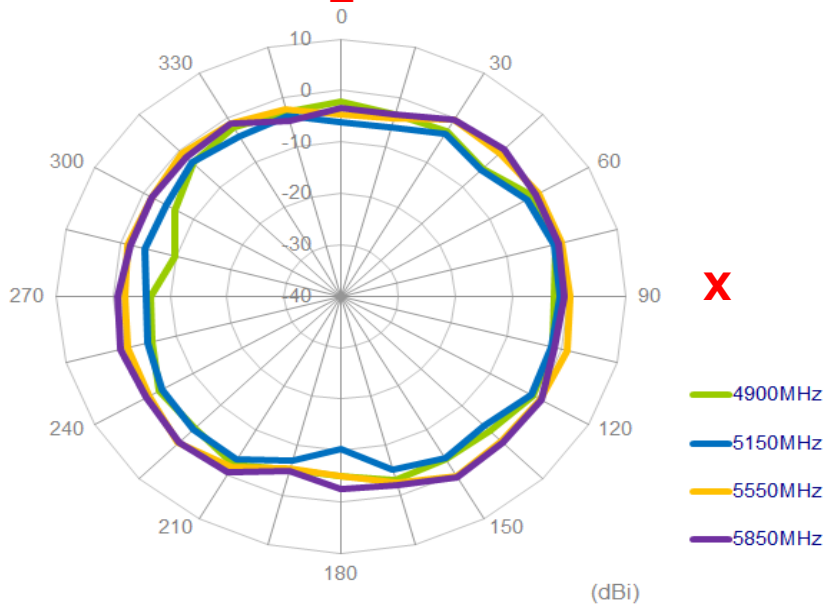

YZ Plane

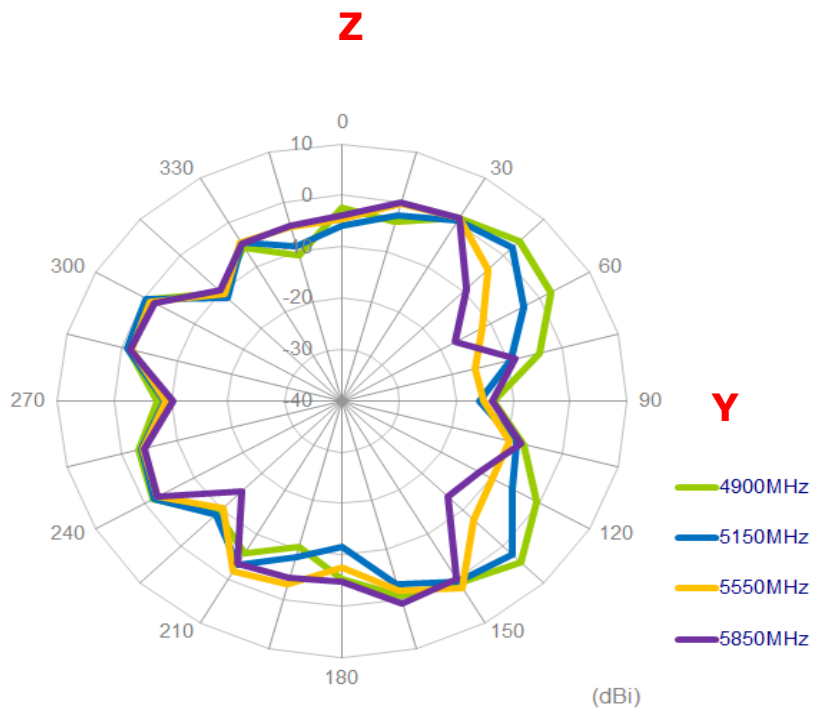
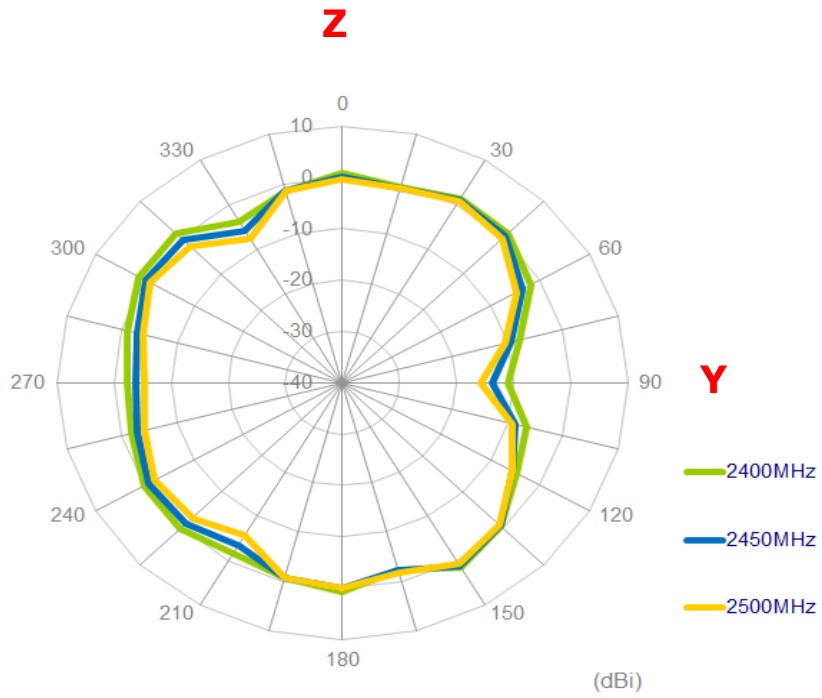

4.2.3 3D Radiation Pattern - Free space

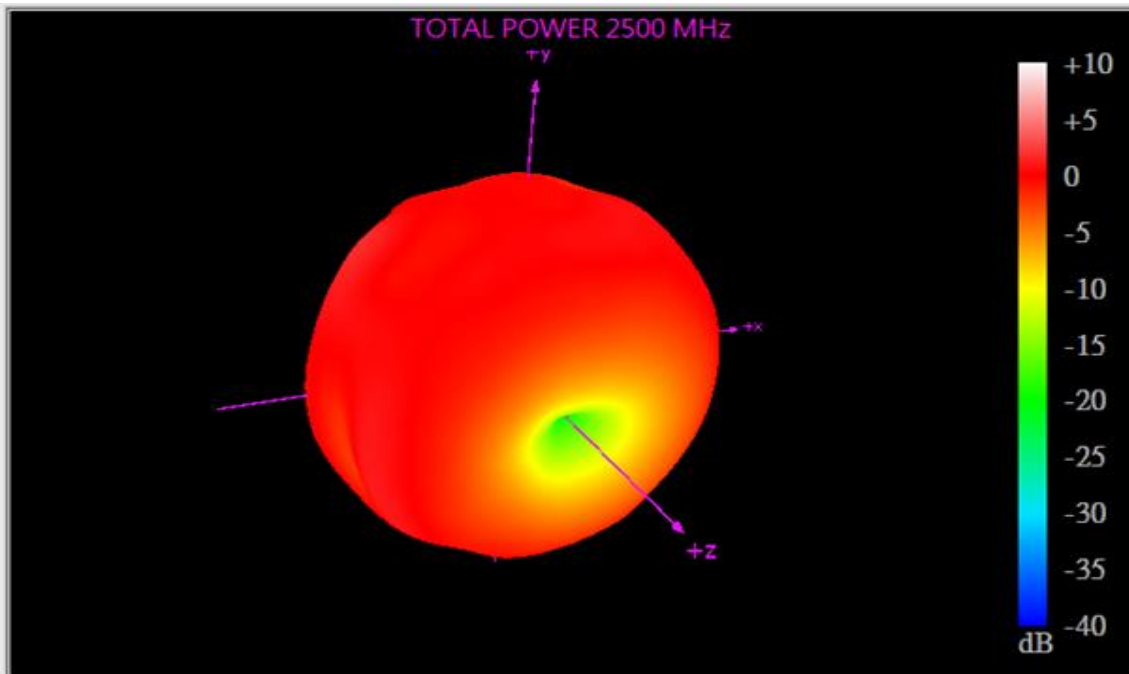
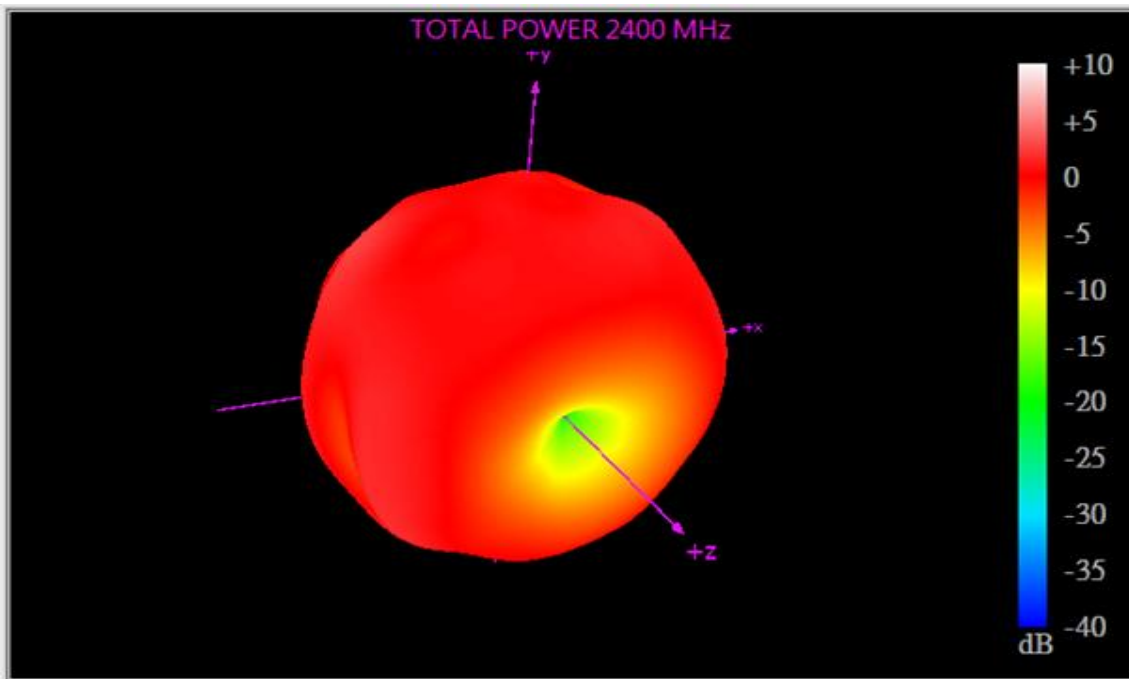

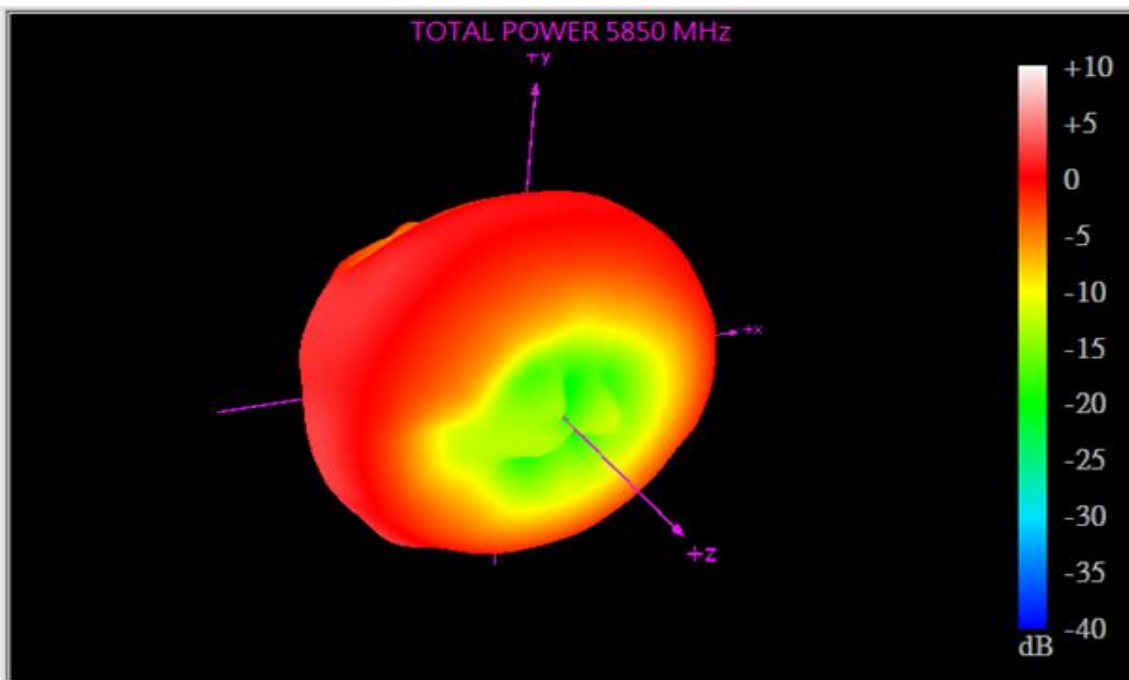
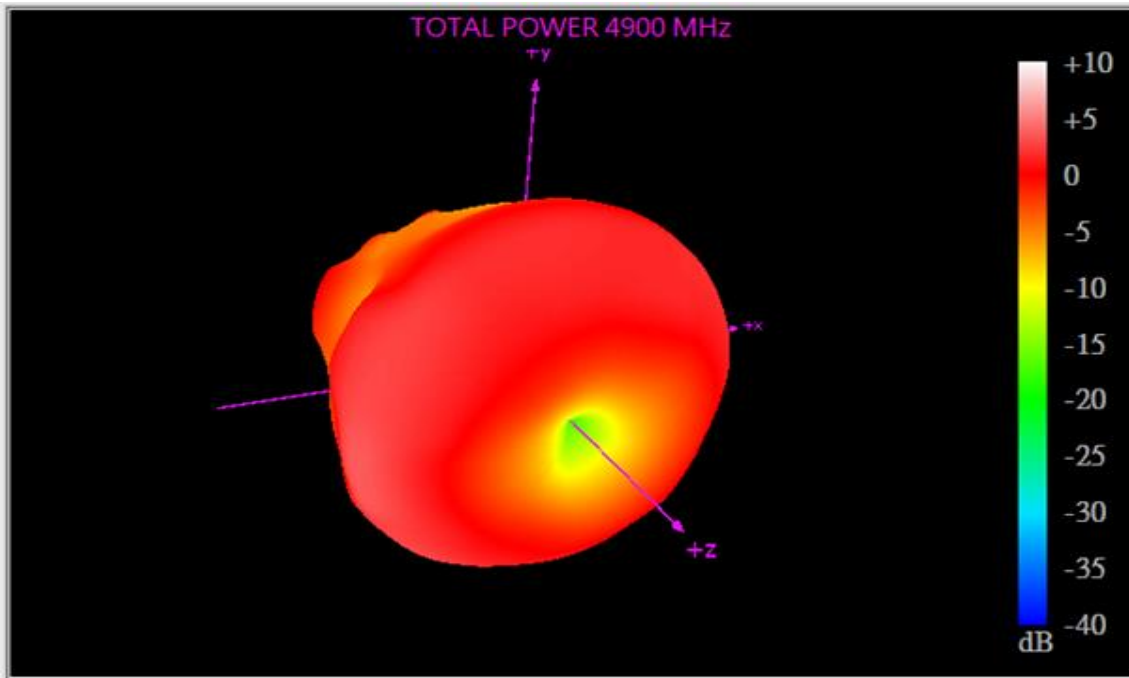

4.2.4 3D Radiation Pattern – with Ground

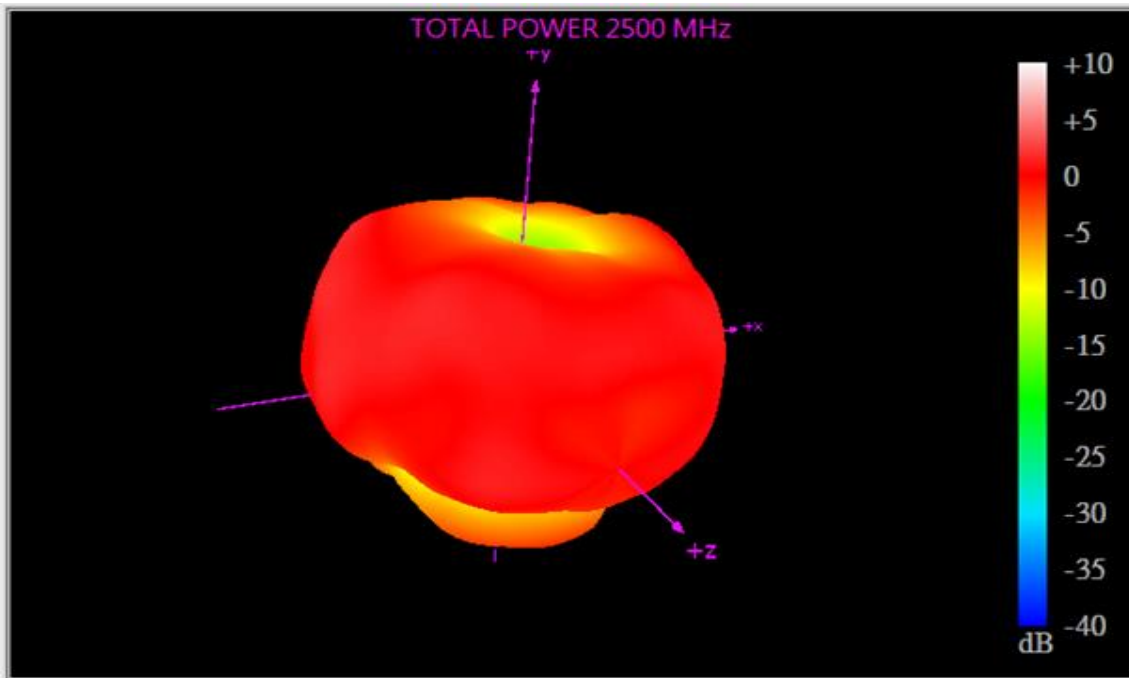
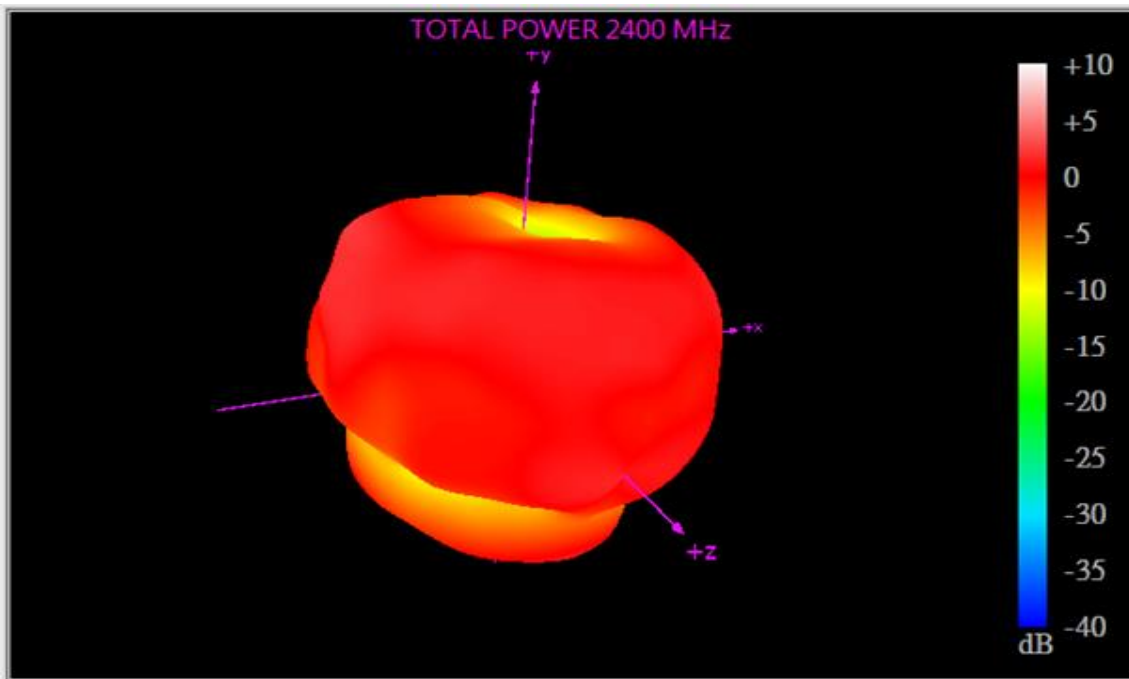

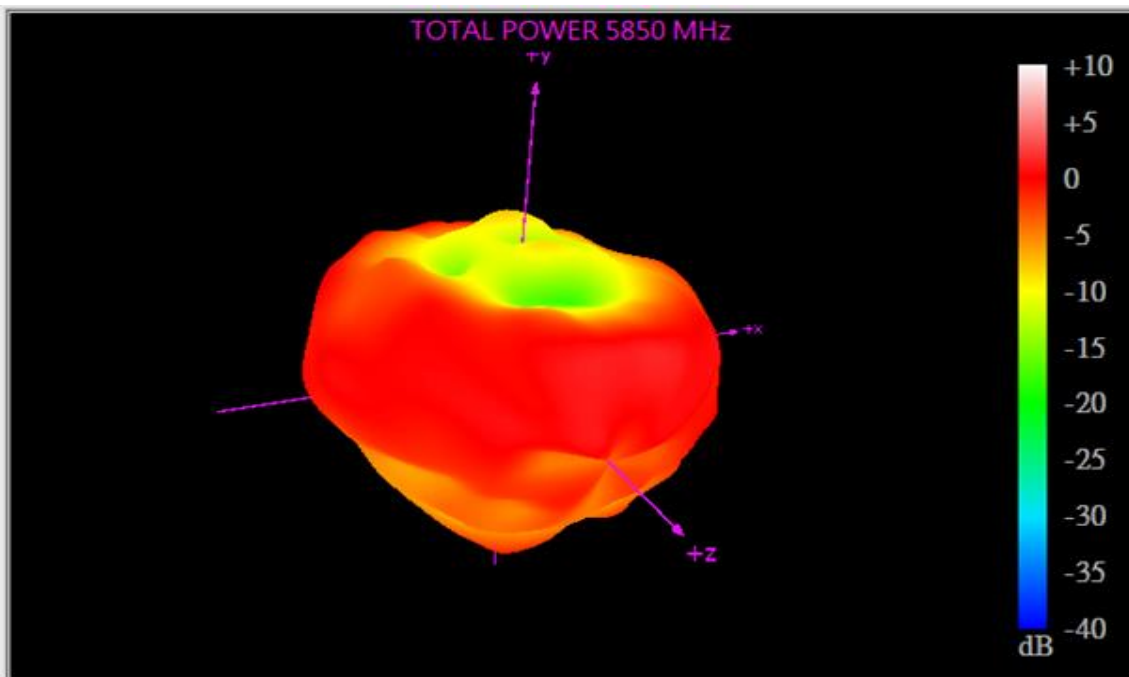
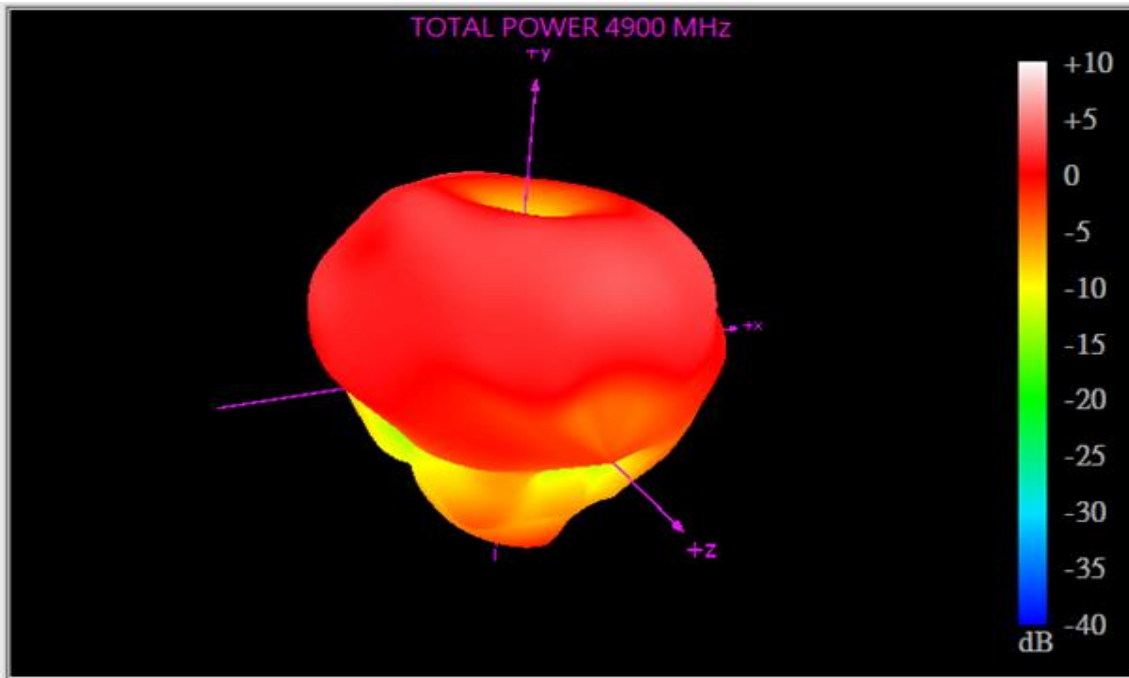

5. Mechanical Drawing (Unit: mm)

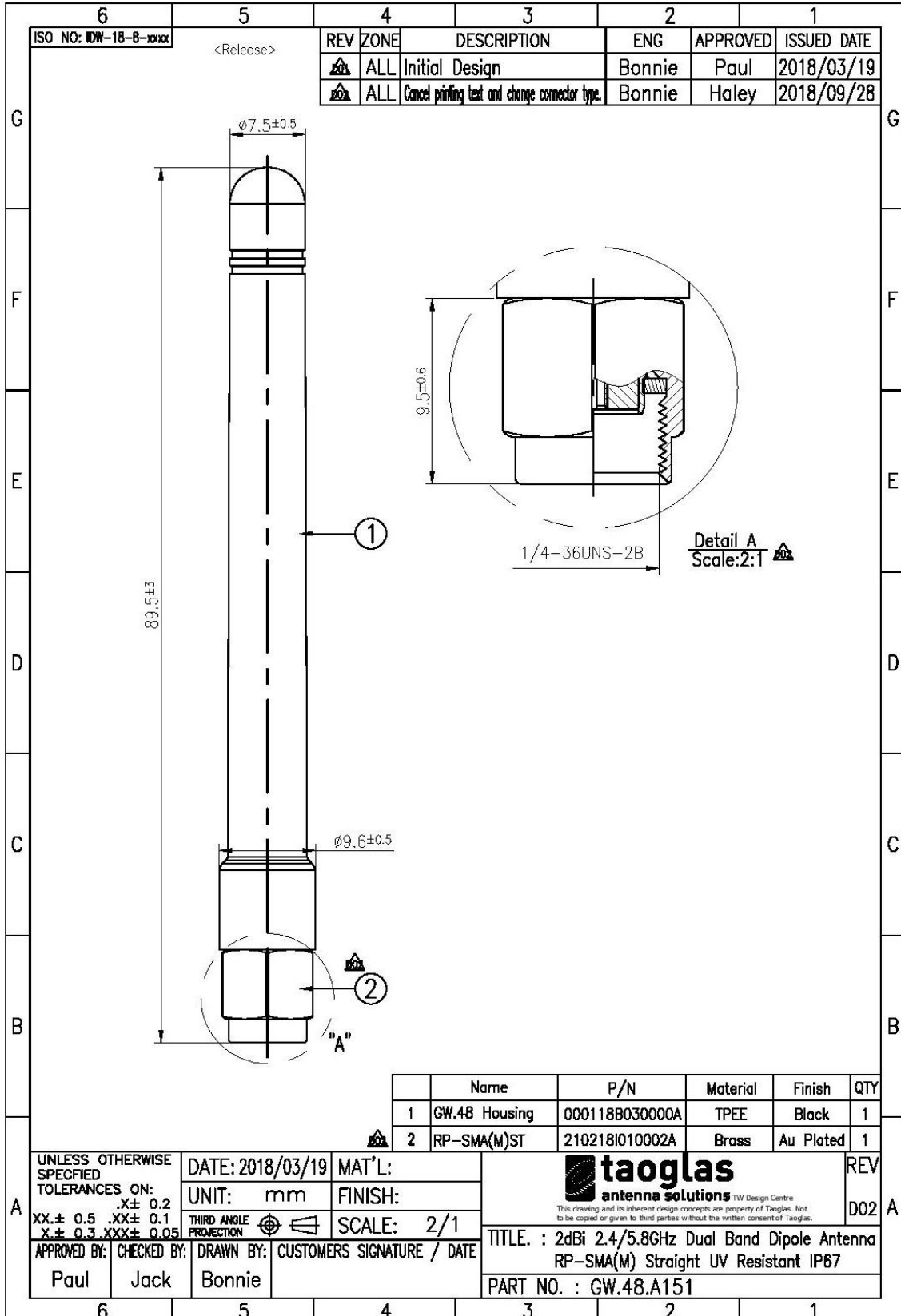

6. Packaging

10 pcs GW.48 per PE Bag
 Bag Dimensions - 100 x 200 mm
 Weight - 86g

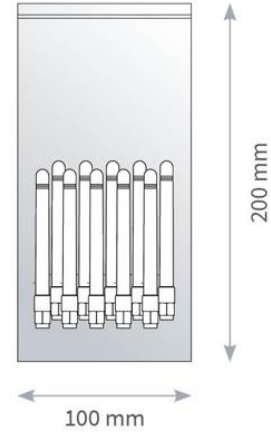

10 Small PE Bag per Large Bag
 100 pcs GW.48 per PE Large Bag
 Bag Dimensions - 300 x 180mm
 Weight - 865g

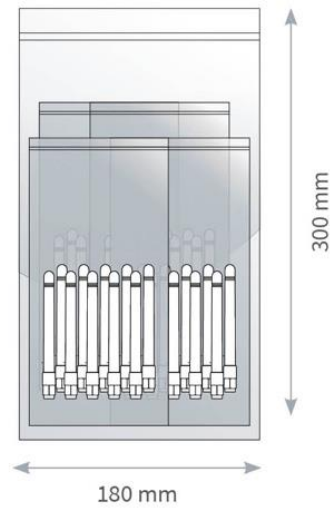

1000 pcs GW.48 per carton
 Carton - 360 x 310 x 160mm
 Weight - 9.6Kg

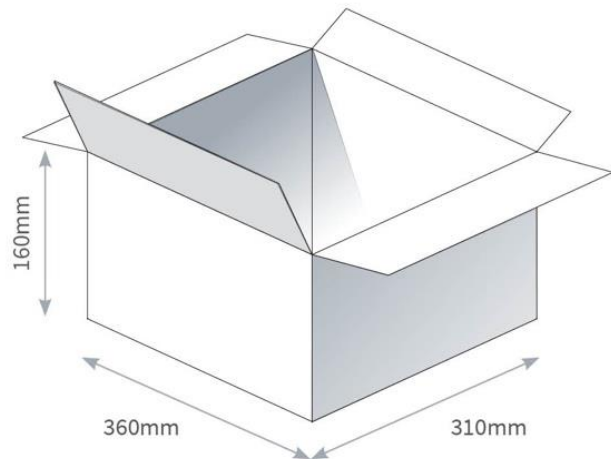

Taoglas makes no warranties based on the accuracy or completeness of the contents of this document and reserves the right to make changes to specifications and product descriptions at any time without notice. Taoglas reserves all rights to this document and the information contained herein.

Reproduction, use or disclosure to third parties without express permission is strictly prohibited.

© Taoglas