

UGT501

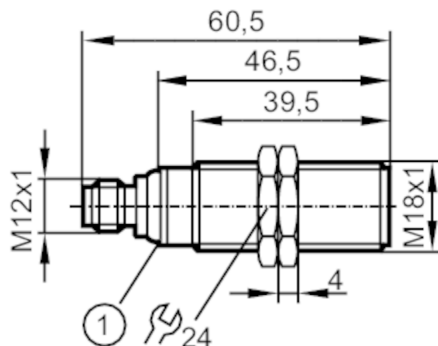

Ultrasonic sensor

UGB00300010G/US



1 LEDs



Product characteristics

Sensing range	[mm]	40...300; (Target: 200 x 200 mm)
Housing		threaded type
Dimensions	[mm]	M18 x 1 / L = 60.5

Electrical data

Operating voltage	[V]	10...30 DC; ("supply class 2" to cULus)
Current consumption	[mA]	< 35
Protection class		III
Reverse polarity protection		yes
Power-on delay time	[s]	< 0.3
Converter frequency	[kHz]	300

Inputs / outputs

Number of inputs and outputs	Number of analogue outputs: 1
------------------------------	-------------------------------

Inputs

Synchronisation input	no
Multiplex input	no

Outputs

Total number of outputs	1	
Number of analogue outputs	1	
Analogue current output	[mA]	4...20
Max. load	[Ω]	500
Short-circuit protection		yes
Overload protection		yes

Detection zone

Sensing range	[mm]	40...300; (Target: 200 x 200 mm)
Blind zone	[mm]	40
Angle of aperture cylindrical	[°]	15; (±2)
Max. deviation from the 90° angle sensor/object	[°]	± 4

UGT501



Ultrasonic sensor

UGB00300010G/US

Accuracy / deviations		
Temperature compensation		yes
Switch point drift	[%]	-5...5
Linearity error of analogue output	[%]	< 1
Notes on the accuracy / deviation	The indicated values are reached after a warm-up time of min. 20 minutes	
Repeatability		1 %
Resolution	[mm]	2
Response times		
Response time	[ms]	< 450; (analogue output)
Operating conditions		
Ambient temperature	[°C]	-20...70
Storage temperature	[°C]	-30...80
Protection		IP 67
Tests / approvals		
EMC	EN 61000-4-2 ESD	4 kV CD / 8 kV AD
	EN 61000-4-3 HF radiated	3 V/m
	EN 61000-4-4 Burst	2 kV
	EN 61000-4-6 HF conducted	3 V
	EN 55011	Class A
Vibration resistance	EN 60068-2-6 Fc	(10-55) Hz 1 mm amplitude, oscillation period 5 min., 30 min. per axis at resonance or 55 Hz
Shock resistance	EN 60068-2-27 Ea	30 g 11 ms half-sine; 3 shocks each in every direction of the 3 coordinate axes
MTTF	[years]	213
UL approval	Ta	-20...70 °C
	voltage supply	Class 2
	File number UL	E174191
Mechanical data		
Weight	[g]	78.5
Housing		threaded type
Dimensions	[mm]	M18 x 1 / L = 60.5
Thread designation		M18 x 1
Materials		stainless steel (1.4404 / 316L); PA; epoxy glass ceramics
Tightening torque	[Nm]	50
Displays / operating elements		
Display	switching status	1 x LED, yellow
	echo	1 x LED, green
Accessories		
Accessories (supplied)	lock nuts: 2, stainless steel	
Remarks		
Remarks	operating voltage "supply class 2" according to cULus	
Pack quantity	1 pcs.	

UGT501



Ultrasonic sensor

UGB00300010G/US

Electrical connection

Connector: 1 x M12



Connection

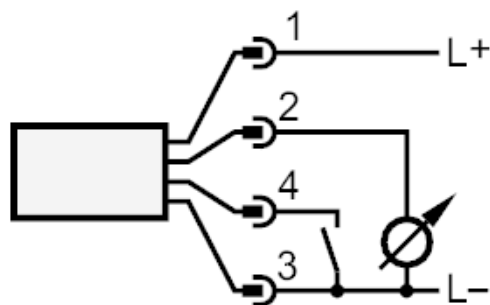

4: Teach

Diagrams and graphs

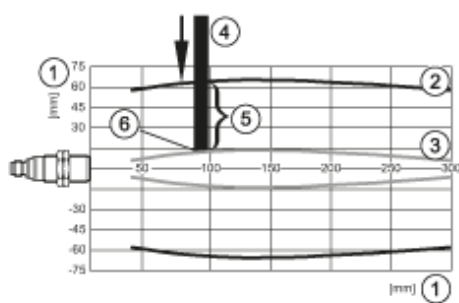
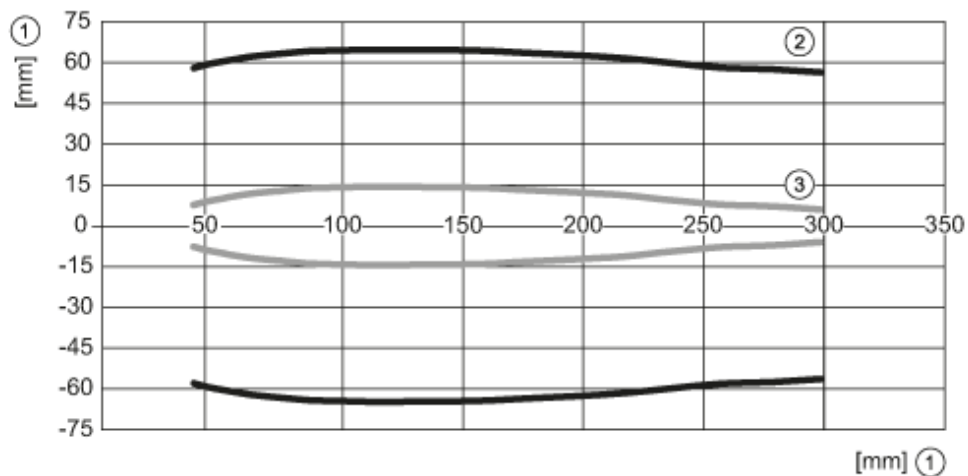

- 1: distance
- 2: Detection zone
- 3: switch-on/switch-off graph
- 4: Target 100 x 100 mm
- 5: 50% of the target in the detection zone
- 6: switch point