

STAR-DELTA CONT. ASSY. AC3:75KW/400V 230 V AC 50/60 HZ  
 SIZE S3, SCREW TERMINALS ELEC. AND MECH. INTERLO.  
 3NO+3NC



Figure similar

|                                      |   |
|--------------------------------------|---|
| <b>Product brand name</b>            | SIRIUS  |
| <b>Product designation</b>           | Contacteur assembly for star-delta (wye-delta) start  |
| <b>Product type designation</b>      | 3RA24   |
| <b>Manufacturer's article number</b> | <ul style="list-style-type: none"> <li>• 1 of the supplied contactor <a href="#">3RT2045-1AL20</a></li> <li>• 2 of the supplied contactor <a href="#">3RT2045-1AL20</a></li> <li>• 3 of the supplied contactor <a href="#">3RT2036-1AL20</a></li> <li>• of the supplied RS assembly kit <a href="#">3RA2943-2C</a></li> <li>• of the supplied function module for wye-delta circuits <a href="#">3RA2816-0EW20</a></li> </ul> |

| General technical data   |       |
|--|-------|
| <b>Size of contactor</b>   | S3    |
| <b>Product extension</b>   | No    |
| <ul style="list-style-type: none"> <li>• Auxiliary switch</li> </ul>                       |       |
| <b>Insulation voltage</b>  | 690 V |
| <ul style="list-style-type: none"> <li>• with degree of pollution 3 rated value</li> </ul> |       |
| <b>Degree of pollution</b>   | 3     |

|  |                              |
|--|------------------------------|
| <b>Surge voltage resistance rated value</b>                  | 6 kV                         |
| <b>Protection class IP</b>                                   |                              |
| • on the front   | IP20                         |
| <b>Shock resistance at rectangular impulse</b>               |                              |
| • at AC  | 6.7 g / 5 ms, 4.0 g / 10 ms  |
| <b>Shock resistance with sine pulse</b>                      |                              |
| • at AC  | 10.6 g / 5 ms, 6.3 g / 10 ms |
| <b>Mechanical service life (switching cycles)</b>            |                              |
| • of contactor typical                                       | 10 000 000                   |
| • of the contactor with added auxiliary switch block typical | 10 000 000                   |
| <b>Equipment marking</b>                                     |                              |
| • acc. to DIN EN 81346-2                                     | Q                            |

#### Ambient conditions

|  |                |
|--|----------------|
| <b>Installation altitude at height above sea level</b> |                |
| • maximum  | 2 000 m        |
| <b>Ambient temperature</b>                             |                |
| • during operation                                     | -25 ... +60 °C |
| • during storage                                       | -55 ... +80 °C |

#### Main circuit

|   |           |
|---|-----------|
| <b>Number of poles for main current circuit</b> | 3         |
| <b>Number of NO contacts for main contacts</b>  | 3         |
| <b>Number of NC contacts for main contacts</b>  | 0         |
| <b>Operating voltage</b>                        |           |
| • at AC-3 rated value maximum                   | 690 V     |
| <b>Operating current</b>                        |           |
| • at AC-1 at 400 V                              |           |
| — at ambient temperature 40 °C rated value      | 125 A     |
| — at ambient temperature 60 °C rated value      | 105 A     |
| <b>Operating frequency</b>                      |           |
| • at AC-1 maximum                               | 900 1/h   |
| • at AC-2 maximum                               | 400 1/h   |
| • at AC-3 maximum                               | 1 000 1/h |
| • at AC-4 maximum                               | 300 1/h   |

#### Control circuit/ Control

|   |       |
|---|-------|
| <b>Type of voltage of the control supply voltage</b>                                  | AC    |
| <b>Control supply voltage 1 at AC</b>   |       |
| • at 50 Hz rated value  | 230 V |
| • at 60 Hz rated value  | 230 V |
| <b>Operating range factor control supply voltage rated value of magnet coil at AC</b> |       |

|   |  |
|---|--|
| <ul style="list-style-type: none"> <li>• at 50 Hz</li> <li>• at 60 Hz</li> </ul>  | <p>0.8 ... 1.1</p> <p>0.85 ... 1.1</p> |
| <b>Apparent pick-up power of magnet coil at AC</b> <ul style="list-style-type: none"> <li>• at 50 Hz</li> <li>• at 60 Hz</li> </ul>               | <p>348 V·A</p> <p>296 V·A</p>          |
| <b>Inductive power factor with closing power of the coil</b> <ul style="list-style-type: none"> <li>• at 50 Hz</li> <li>• at 60 Hz</li> </ul>     | <p>0.62</p> <p>0.55</p>                |
| <b>Apparent holding power of magnet coil at AC</b> <ul style="list-style-type: none"> <li>• at 50 Hz</li> <li>• at 60 Hz</li> </ul>               | <p>25 V·A</p> <p>18 V·A</p>            |
| <b>Inductive power factor with the holding power of the coil</b> <ul style="list-style-type: none"> <li>• at 50 Hz</li> <li>• at 60 Hz</li> </ul> | <p>0.35</p> <p>0.41</p>                |

### Auxiliary circuit

|  |  |
|--|--|
| <b>Number of NC contacts</b> <ul style="list-style-type: none"> <li>• for auxiliary contacts <ul style="list-style-type: none"> <li>— instantaneous contact</li> </ul> </li> </ul> | <p>3</p>                                       |
| <b>Number of NO contacts</b> <ul style="list-style-type: none"> <li>• for auxiliary contacts <ul style="list-style-type: none"> <li>— instantaneous contact</li> </ul> </li> </ul> | <p>3</p>                                       |
| <b>Operating current of auxiliary contacts at AC-12 maximum</b>  | <p>10 A</p>                                    |
| <b>Operating current of auxiliary contacts at AC-15</b> <ul style="list-style-type: none"> <li>• at 230 V</li> <li>• at 400 V</li> </ul>   | <p>6 A</p> <p>3 A</p>                          |
| <b>Operating current of auxiliary contacts at DC-13</b> <ul style="list-style-type: none"> <li>• at 24 V</li> <li>• at 60 V</li> <li>• at 110 V</li> <li>• at 220 V</li> </ul>     | <p>10 A</p> <p>2 A</p> <p>1 A</p> <p>0.3 A</p> |

### UL/CSA ratings

|   |                    |
|---|--------------------|
| <b>Contact rating of auxiliary contacts according to UL</b> | <p>A600 / Q600</p> |
|---|--------------------|

### Short-circuit protection

|  |  |
|--|--|
| <b>Design of the fuse link</b> <ul style="list-style-type: none"> <li>• for short-circuit protection of the main circuit <ul style="list-style-type: none"> <li>— with type of coordination 1 required</li> <li>— with type of assignment 2 required</li> </ul> </li> <li>• for short-circuit protection of the auxiliary switch required</li> </ul> | <p>gG NH 3NA, DIAZED 5SB, NEOZED 5SE: 250 A</p> <p>gG NH 3NA, DIAZED 5SB, NEOZED 5SE: 160 A</p> <p>fuse gG: 10 A</p> |
|--|--|

## Installation/ mounting/ dimensions

|   |  |
|---|--|
| <b>Mounting position</b>  | +/-180° rotation possible on vertical mounting surface; can be tilted forward and backward by +/- 22.5° on vertical mounting surface |
| <b>Mounting type</b>  | screw and snap-on mounting onto 35 mm standard mounting rail   |
| <b>Height</b>   | 180 mm   |
| <b>Width</b>  | 220 mm   |
| <b>Depth</b>  | 244 mm   |
| <b>Required spacing</b>   |  |
| <ul style="list-style-type: none"> <li>• with side-by-side mounting <ul style="list-style-type: none"> <li>— forwards 10 mm</li> <li>— Backwards 0 mm</li> <li>— upwards 10 mm</li> <li>— downwards 10 mm</li> <li>— at the side 10 mm</li> </ul> </li> <li>• for grounded parts <ul style="list-style-type: none"> <li>— forwards 10 mm</li> <li>— Backwards 0 mm</li> <li>— upwards 10 mm</li> <li>— at the side 10 mm</li> <li>— downwards 10 mm</li> </ul> </li> <li>• for live parts <ul style="list-style-type: none"> <li>— forwards 10 mm</li> <li>— Backwards 0 mm</li> <li>— upwards 10 mm</li> <li>— downwards 10 mm</li> <li>— at the side 10 mm</li> </ul> </li> </ul> |  |

## Connections/Terminals

|   |   |
|---|---|
| <b>Type of electrical connection</b>  |   |
| <ul style="list-style-type: none"> <li>• for main current circuit</li> <li>• for auxiliary and control current circuit</li> </ul>   | <p>screw-type terminals</p> <p>screw-type terminals</p>   |
| <b>Type of connectable conductor cross-sections</b>   |   |
| <ul style="list-style-type: none"> <li>• for main contacts <ul style="list-style-type: none"> <li>— single or multi-stranded</li> <li>— finely stranded with core end processing</li> <li>— finely stranded without core end processing</li> </ul> </li> <li>• at AWG conductors for main contacts</li> </ul> | <p>2x (2.5 ... 16 mm<sup>2</sup>), 2x (10 ... 50 mm<sup>2</sup>), 1x (10 ... 70 mm<sup>2</sup>)</p> <p>2x (2.5 ... 35 mm<sup>2</sup>), 1x (2.5 ... 50 mm<sup>2</sup>)</p> <p>2x (10 ... 35 mm<sup>2</sup>), 1x (10 ... 50 mm<sup>2</sup>)</p> <p>2x (10 ... 1/0), 1x (10 ... 2/0)</p> |
| <b>Type of connectable conductor cross-sections</b>   |   |
| <ul style="list-style-type: none"> <li>• for auxiliary contacts <ul style="list-style-type: none"> <li>— single or multi-stranded</li> <li>— finely stranded with core end processing</li> </ul> </li> </ul>  | <p>2x (0,5 ... 1,5 mm<sup>2</sup>), 2x (0,75 ... 2,5 mm<sup>2</sup>)</p> <p>2x (0.5 ... 1.5 mm<sup>2</sup>), 2x (0.75 ... 2.5 mm<sup>2</sup>)</p>   |

- at AWG conductors for auxiliary contacts

2x (20 ... 16), 2x (18 ... 14)







### Safety related data

|   |           |
|---|-----------|
| <b>B10 value</b>  |           |
| • with high demand rate acc. to SN 31920                                  | 1 000 000 |
| <b>Proportion of dangerous failures</b>                                   |           |
| • with low demand rate acc. to SN 31920                                   | 40 %      |
| • with high demand rate acc. to SN 31920                                  | 73 %      |
| <b>Failure rate [FIT]</b>   |           |
| • with low demand rate acc. to SN 31920                                   | 100 FIT   |
| <b>T1 value for proof test interval or service life acc. to IEC 61508</b> | 20 y      |

### Communication/ Protocol

|  |    |
|--|----|
| <b>Product function Bus communication</b>                      | No |
| <b>Protocol is supported</b>                                   |    |
| • AS-interface protocol  | No |
| <b>Product function Control circuit interface with IO link</b> | No |

### Certificates/approvals

| General Product Approval  | Declaration of Conformity   | Marine / Shipping   |   |   |   |
|---|---|---|---|---|---|
|  | <br>EG-Konf. |  |  |  |  |
|   |   | BUREAU<br>VERITAS   | GL  | LRS   | RMRS  |
| <b>Marine / Shipping</b>  | <b>other</b>  |   |   |   |   |



[Confirmation](#)

### Further information

**Information- and Downloadcenter (Catalogs, Brochures,...)**

<http://www.siemens.com/industrial-controls/catalogs>

**Industry Mall (Online ordering system)**

<https://mall.industry.siemens.com/mall/en/en/Catalog/product?mlfb=3RA2445-8XF32-1AL2>

**Cax online generator**

<http://support.automation.siemens.com/WW/CAXorder/default.aspx?lang=en&mlfb=3RA2445-8XF32-1AL2>

**Service&Support (Manuals, Certificates, Characteristics, FAQs,...)**

<https://support.industry.siemens.com/cs/ww/en/ps/3RA2445-8XF32-1AL2>

**Image database (product images, 2D dimension drawings, 3D models, device circuit diagrams, EPLAN macros, ...)**

[http://www.automation.siemens.com/bilddb/cax\\_de.aspx?mlfb=3RA2445-8XF32-1AL2&lang=en](http://www.automation.siemens.com/bilddb/cax_de.aspx?mlfb=3RA2445-8XF32-1AL2&lang=en)

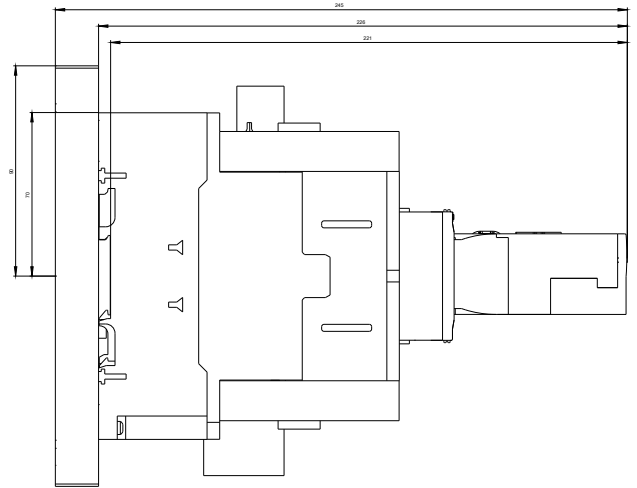
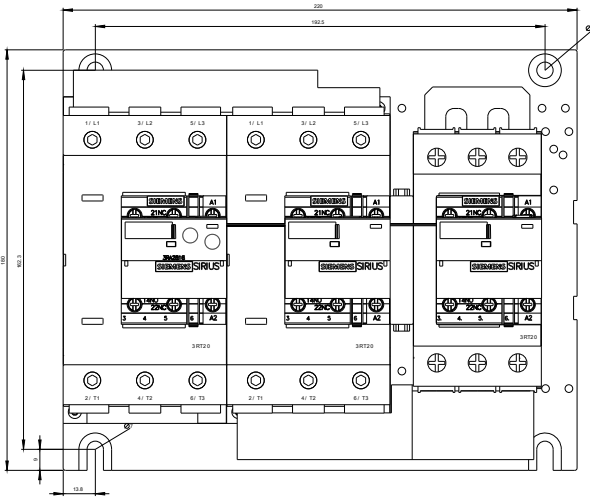

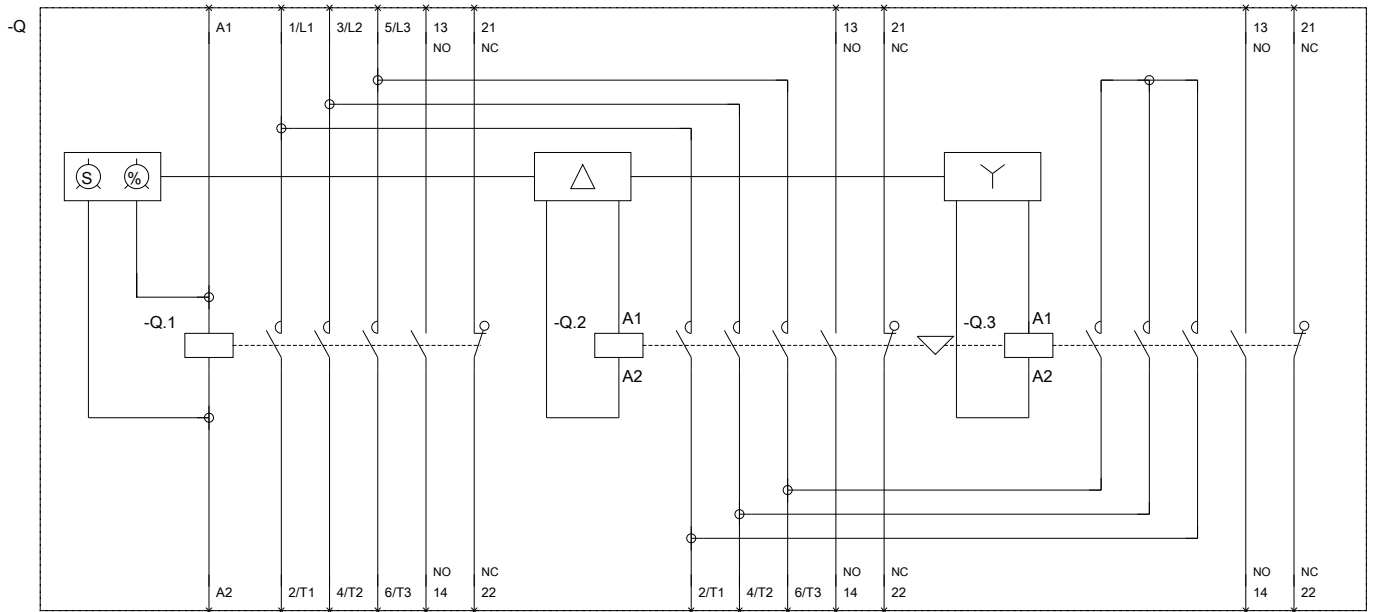

last modified:

10/13/2017