

Actuator/Sensor cable, PUR
Connection cable
RSC4T-10/TXG

TURCK

Industrial
Automation

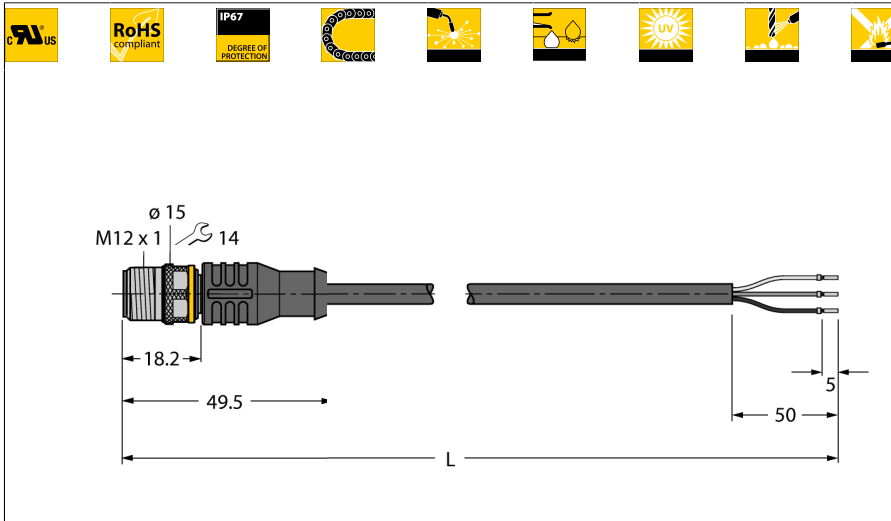

- Male M12, straight, 3-pin
- Sheath material: PUR
- Sheath color: grey
- Qualified for drag chain use
- Resistant to weld splatter
- Resistant to chemicals, UV radiation and oils
- Flame retardant
- Free from halogen, silicone, PVC and LABS
- Particularly resistant to abrasion
- Approval: cULus
- RoHS conform
- Protection class IP67
- Cable length: 10 m

Type designation	RSC4T-10/TXG
Ident no.	6629431
Connector A side	Connector, M12 ♂ 1, Straight
Number of pins	3
Contacts	Brass, CuZn, Gold-plated
Contact carriers	Plastic, TPU, Black
Grip	Plastic, TPU, Black
Coupling nut/screw	Brass, CuZn, Nickel-plated
Protection class	IP67, A + B side screwed together
Mechanical lifespan	> 100 Mating cycles
Pollution degree	3
Tightening torque	0.8 ... 1 Nm (observe max. torque of counter piece!)

General data	
Cable diameter	4.3 ± 0.20mm
Cable length	10 m
Cable quality	PUR
Cable color	Gray
Core insulation	PP
Core colors	BN, BU, BK
Core cross-section	3x0.34mm ²
Arrangement of strands	42x0.1 mm

Electrical features at +20 °C	
Current	4 A
Rated voltage	250 V
Insulation resistance	> 30.5 MΩ/km
Test voltage	2000 V
Forward resistance	max. 57 Ω/km

Mechanical and chemical properties	
Max. tensile strength (static)	≤ 50 N/mm ²
Max. tensile strength (dynamic)	≤ 20 N/mm ²
Bending cycles	> 5 mil.
Bending radius (stationary laying)	> 5 x Ø
Bending radius (flexible use)	> 10 x Ø
Admissible acceleration	max. 5 m/s ²
Admissible travel path, horizontal	5 m (at 5 m/s ²)
Admissible travel path, vertical	2 m (at 5 m/s ²)
Admissible traversing speed	3.3 m/s
Torsional stress	± 180 °/m
Ambient temperature	
Stationary	-50...+80°C
In motion	-25...+80°C
Drag chain operation	-25...+60°C

Cable Cross-section

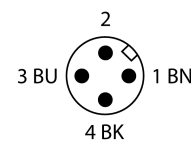
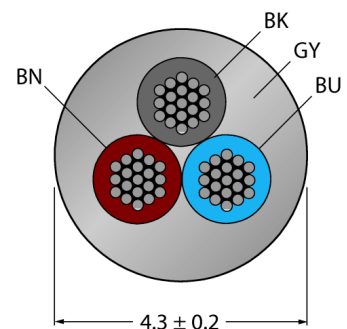

General information

Drawing depicts design version including hexagon coupling nut (Production date after CW11/2016).

Circuit Diagram

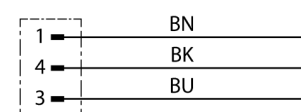





Actuator/Sensor cable, PUR
Connection cable
RSC4T-10/TXG

TURCK

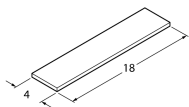
Industrial
Automation

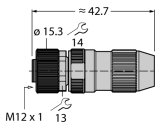
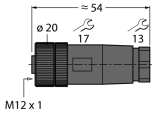
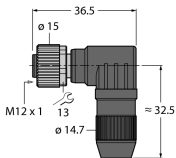
Accessories

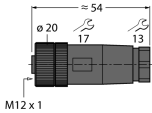
Type code	Ident no.	Description	
Torque-Wrench-Set-AS	6936170	Torque wrench set; handles with adjustable torque 0.4-1.0 Nm, torque wrench for M8 (SW9), fork wrench for M12 (SW 14)	
BLANK-LABEL-FOR-CORDSETS-TEL-TXL	6936206	Label for TEL and TXL cables, length: 18 mm, height: 4 mm, material: polycarbonate (PC), color: white, halogen-free and flame-retardant	
HA8141-0	6905407	Field-wireable female connector, M12  1, straight, 4-pin, insulation piercing connection, cable feedthrough 4.0 to 5.1 mm, core cross-section/terminal capacity 0.14 to 0.34 mm ² , plastic housing, metal nut	
HA8241-0	6905401	Field-wireable female connector, M12  1, angled, 4-pin, insulation piercing connection, cable feedthrough 4.0 to 5.1 mm, core cross-section/terminal capacity 0.14 to 0.34 mm ² , plastic housing, metal nut	
B8141-0	69049	Field-wireable female connector, M12  1, straight, 4-pin, screw terminal connection, cable feedthrough 4.0 to 6.0 mm, core cross-section/terminal capacity 0.14 to 0.75 mm ² , plastic housing, plastic nut	

Actuator/Sensor cable, PUR
Connection cable
RSC4T-10/TXG

Accessories

Type code	Ident no.	Description	
B8241-0	69048	Field-wireable female connector, M12 4-pin, angled, 4-pin, screw terminal connection, cable feedthrough 4.0 to 6.0 mm, core cross-section/terminal capacity 0.14 to 0.75 mm ² , plastic housing, plastic nut	
BM8141-0	6935145	Field-wireable female connector, M12 4-pin, straight, 4-pin, screw terminal connection, cable feedthrough 4.0 to 6.0 mm, core cross-section/terminal capacity 0.25 to 0.75 mm ² , plastic housing, metal nut	
BM8241-0	6935889	Field-wireable female connector, M12 4-pin, angled, 4-pin, screw terminal connection, cable feedthrough 4.0 to 6.0 mm, core cross-section/terminal capacity 0.25 to 0.75 mm ² , plastic housing, metal nut	