

# FILTERING

## ROUND CABLE FERRITES

### Applications

The RH type bead cores are mainly produced for the cable wire assemblers and MATV CATV makers.

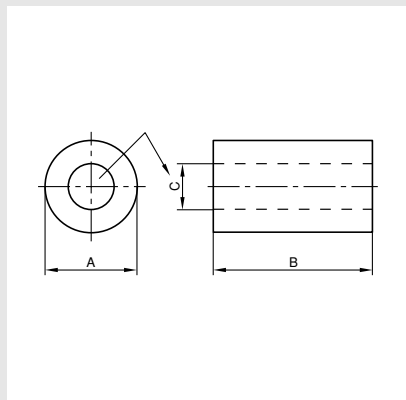

Part No.	Unit: mm			Impedance (Ω)	
	A	B	C	25MHz	100MHz
RI 2.5-4-0.8	2.5±0.15	4.0±0.3	0.8±0.15	38	62
RI 3-3-1.2	3.0±0.15	3.0±0.2	1.2±0.15	28	53
RI 3-4-1	3.0±0.15	4.0±0.3	1.0±0.15	37	44
RI 3.5-3-1.2	3.5±0.15	3.0±0.2	1.2±0.15	27	48
RI 3.5-3.5-1.2	3.5±0.15	3.5±0.2	1.2±0.15	22	40
RI 3.5-4-1.2	3.5±0.15	4.0±0.3	1.2±0.15	30	51
RI 3.5-5-1.8	3.5±0.15	5.0±0.3	1.8±0.15	27	47
RI 3.5-6-1.2	3.5±0.15	6.0±0.3	1.2±0.15	45	73
RI 3.5-7-1.2	3.5±0.15	7.0±0.3	1.2±0.15	40	63
RI 3.5-14-0.8	3.5±0.15	14.0±0.4	0.8±0.15	144	212
RI 4-5-2	4.0±0.2	5.0±0.3	2.0±0.15	28	51
RI 4-10-2	4.0±0.2	10.0±0.4	2.0±0.15	50	85
RI 4.8-6.4-2.3	4.83±0.2	6.35±0.3	2.29±0.15	43	80
RI 5-5-2.3	5.0±0.2	5.0±0.3	2.3±0.15	30	55
RI 5-11-1.5	5.0±0.2	11.0±0.4	1.5±0.15	93	150
RI 5-18-2.2	5.0±0.2	18.0±0.4	2.15±0.15	128	147
RI 6-18-3.2	6.0±0.2	18.0±0.4	3.15±0.2	100	155
RI 6.4-12.7-3.3	6.35±0.2	12.7±0.4	3.3±0.2	67	105
RI 7.5-7.5-2.4	7.50±0.3	7.50±0.3	2.40±0.15	60	102
RI 8-9.8-6	8.0±0.2	9.8±0.3	6.0±0.3	35	55
RI 8-10.1-3.2	8.0±0.2	10.06±0.4	3.18±0.2	67	115
RI 9.3-9.5-4.5	9.3±0.3	9.5±0.3	4.5±0.25	51	78
RI 9.5-9.5-5.2	9.5±0.3	9.5±0.3	5.2±0.25	45	78
RI 9.5-10-5.8	9.5±0.3	10.0±0.3	5.8±0.2	43	66
RI 9.5-10.4-5	9.5±0.3	10.4±0.4	5.0±0.25	53	81
RI 9.5-14.5-5	9.5±0.3	14.5±0.4	5.0±0.25	75	121
RI 9.5-19-5	9.5±0.3	19.0±0.4	5.0±0.25	95	135
RI 10-6.2-6.0	10.0±0.2	6.2±0.3	6.0±0.2	27	47
RI 10-10-7	10.0±0.3	10.0±0.4	7.0±0.3	31	57
RI 10-14-6	10.0±0.3	14.0±0.4	6.0±0.3	45	73

Part No.	Unit: mm			Impedance (Ω)	
	A	B	C	25MHz	100MHz
RI 11-20-5	10.5±0.3	20.0±0.5	5.5±0.25	95	135
RI 11-18-5	11.0±0.3	18.5±0.4	5.0±0.25	127	166
RI 11-25-5	11.0±0.3	25.0±0.6	5.0±0.25	166	217
RI 11.8-15-73	11.8±0.3	15.0±0.4	7.0±0.3	54	75
RI 12.0-75-70	12.0±0.3	7.5±0.3	7.0±0.3	31	55
RI 12-15-7	12.0±0.3	15.0±0.4	7.0±0.3	60	92
RI 12-15-8.5	12.0±0.3	15.0±0.4	8.5±0.3	45	85
RI 12-16-8.5	12.0±0.5	16.0±0.5	8.5±0.25	43	63
RI 12-20-5.6	12.0±0.3	20.0±0.5	5.6±0.25	118	173
RI 12-30-5.6	12.0±0.3	30.0±0.6	5.6±0.2	150	286
RI 12.3-25.4-4.9	12.32±0.3	25.4±0.6	4.88±0.2	172	264
RI 12.5-12.5-8	12.5±0.3	12.5±0.4	8.0±0.3	37	57
RI 12.7-12.7-79	12.7±0.3	12.7±0.4	7.9±0.3	43	65
RI 14-18-6	14.2±0.3	18.0±0.4	6.35±0.25	70	125
RI 14.2-15-6.4	14.2±0.4	15.0±0.4	6.35±0.3	92	146
RI 14.2-15-8	14.2±0.4	15.0±0.4	8.0±0.3	63	107
RI 14.2-28.5-6.4	14.2±0.4	28.5±0.6	6.35±0.3	180	258
RI 14.2-28.5-7	14.2±0.4	28.5±0.6	7.0±0.3	141	221
RI 14.2-28.5-8	14.2±0.4	28.5±0.6	8.0±0.3	128	195
RI 15-12-10.5	15.0±0.4	12.0±0.4	10.5±0.4	38	61
RI 15.3-28-8	15.25±0.4	28.0±0.6	8.0±0.3	123	173
RI 15.7-28.6-6.99	15.65±0.4	28.57±0.6	6.99±0.3	164	258
RI 15.9-28.6-7.9	15.88±0.4	28.57±0.6	7.87±0.3	148	241
RI 16-28-7	16.0±0.4	28.0±0.6	7.0±0.3	192	304
RI 16-28-9	16.0±0.4	28.0±0.6	9.0±0.3	133	217
RI 16-28.5-8	16.0±0.4	28.5±0.6	8.0±0.3	117	237
RI 16-17-9	16.0±0.4	17.0±0.4	9.0±0.3	60	113
RI 17.1-25.4-8.8	17.07±0.4	25.4±0.6	8.76±0.3	122	180
RI 17.5-28.5-9.5	17.5±0.4	28.5±0.6	9.5±0.3	143	213
RI 17.5-28.5-10.7	17.5±0.4	28.5±0.6	10.7±0.4	96	149
RI 17.5-35-9.5	17.5±0.4	35.0±0.8	9.5±0.3	159	243
RI 18-28-10	18.0±0.5	28.0±0.6	10.0±0.4	130	206
RI 19-29-13	19.0±0.5	29.0±0.6	13.0±0.4	60	105
RI 25.9-28.6-12.8	25.91±0.46	28.57±0.6	12.83±0.4	127	195
RI 26-28-13	26.0±0.6	28.0±0.7	13.0±0.4	141	223
RI 28-28-14	28.0±0.6	28.5±0.6	14.0±0.4	163	247
RI 28.5-28.6-13.8	28.5±0.46	28.57±0.6	13.77±0.4	158	250

# FILTERING

## ROUND CABLE FERRITES

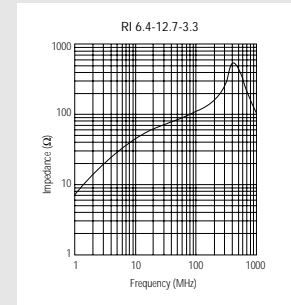
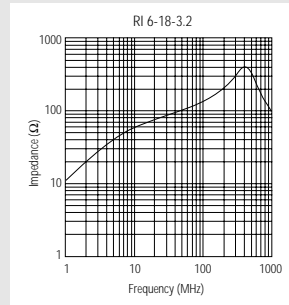
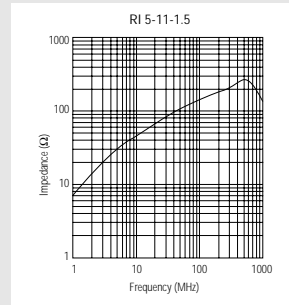
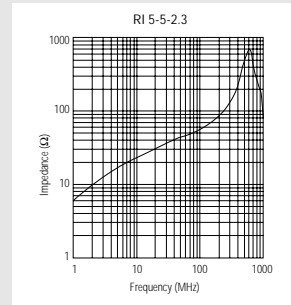
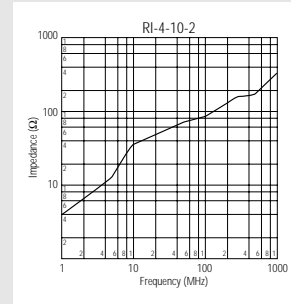
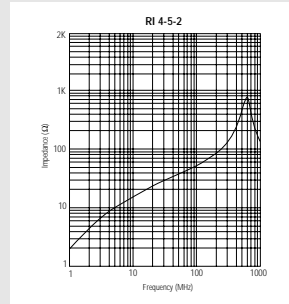
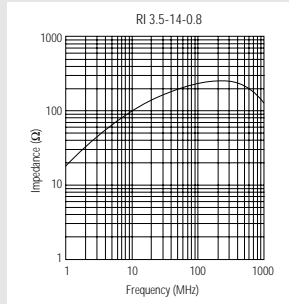
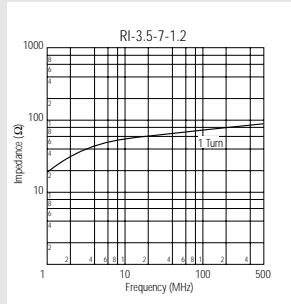
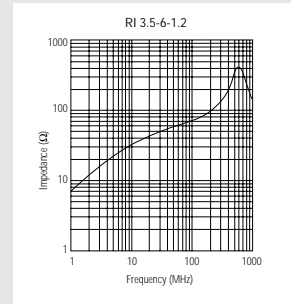
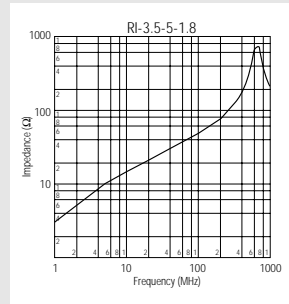
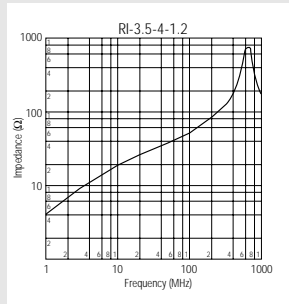
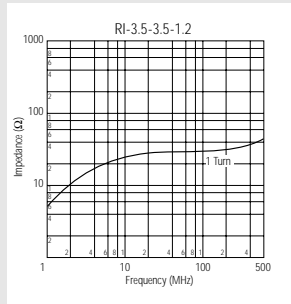
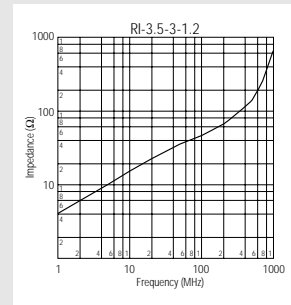
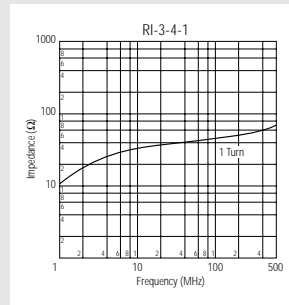
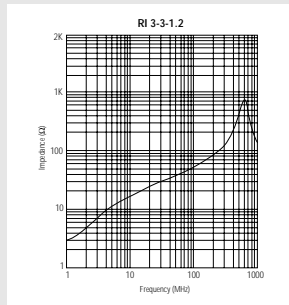
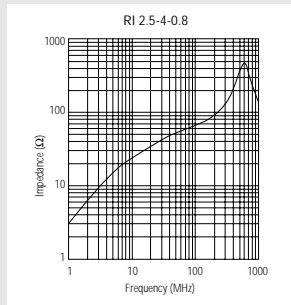

# FILTERING

## ROUND CABLE FERRITES

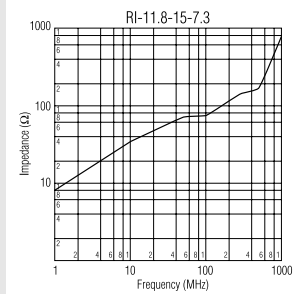
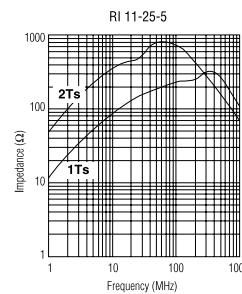
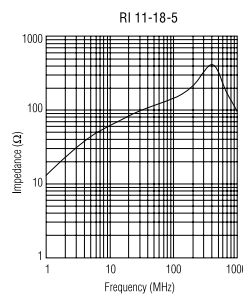
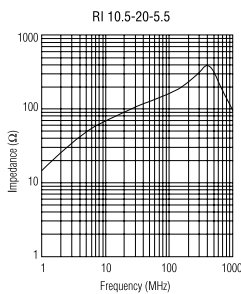
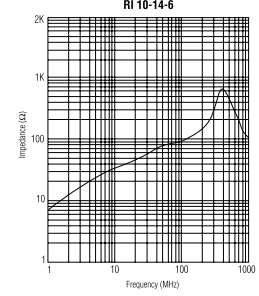
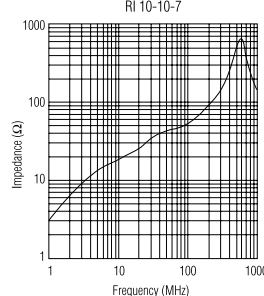
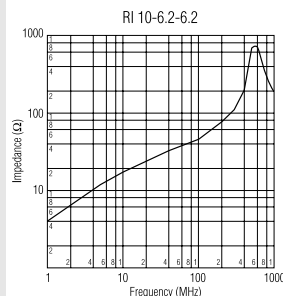
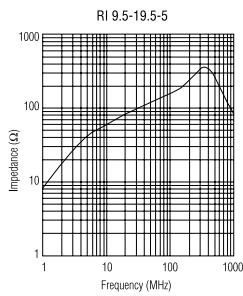
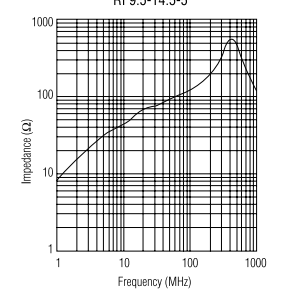
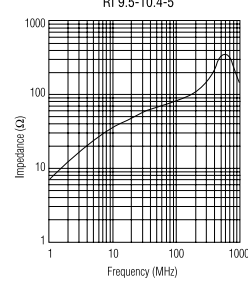
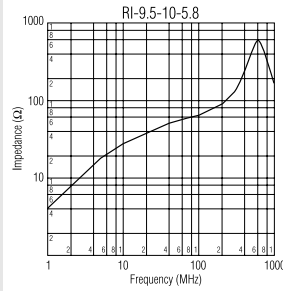
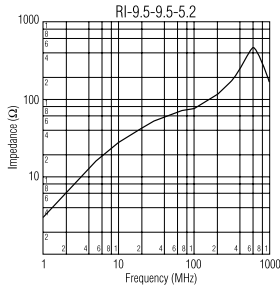
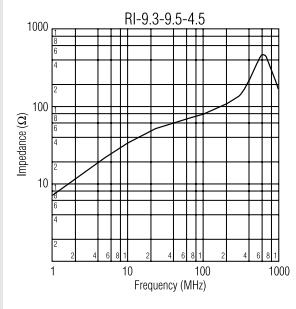
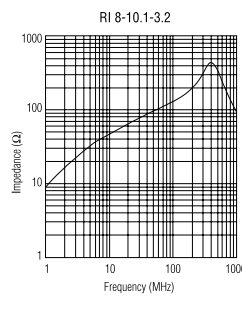
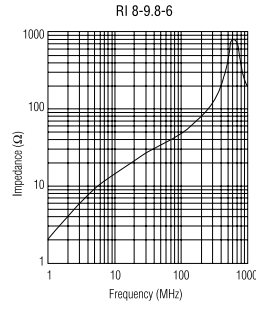
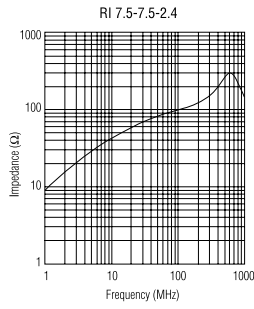

# FILTERING

## ROUND CABLE FERRITES

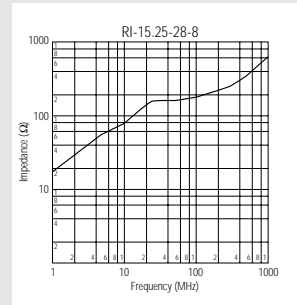
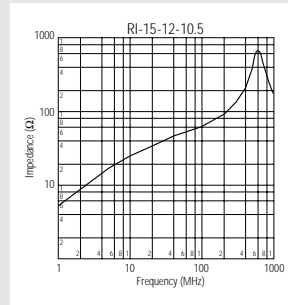
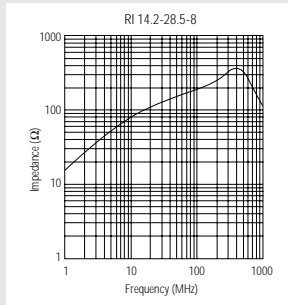
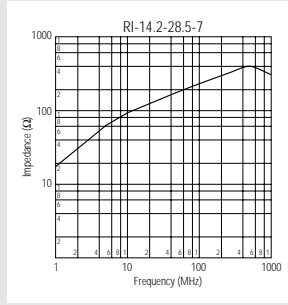
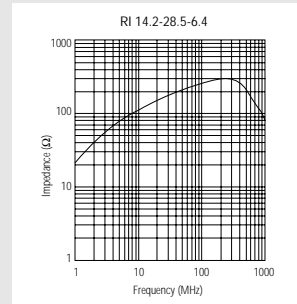
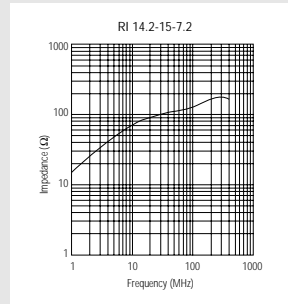
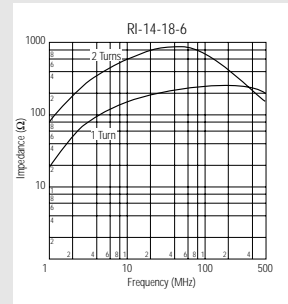
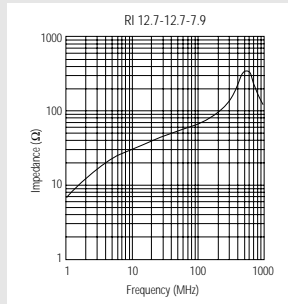
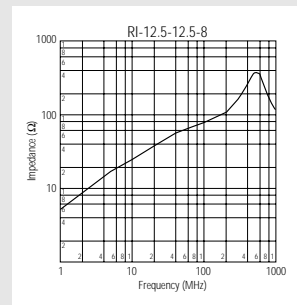
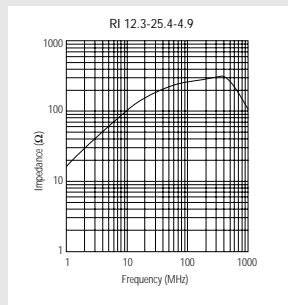
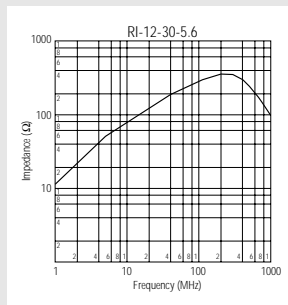
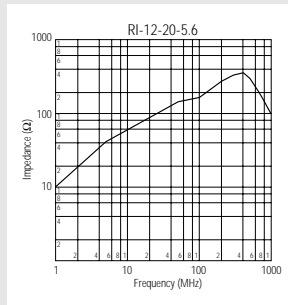
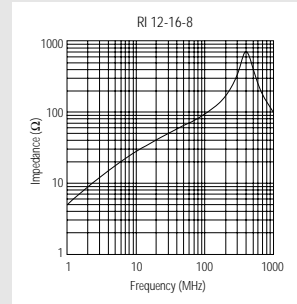
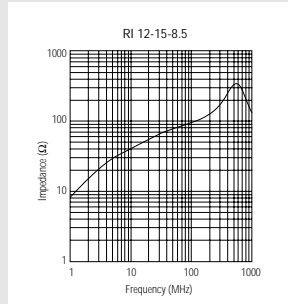
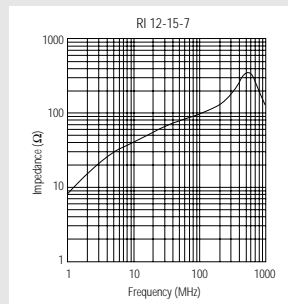
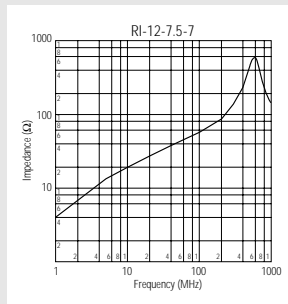

# FILTERING

## ROUND CABLE FERRITES

