

ADAPTER CYLINDER LOCK ACCESSORY POCKET ACCESSORY  
FOR: 3VA5 125







## Model

Product designation

Accessories

## Certificates

General Product Approval	EMC	Declaration of Conformity	other
 CSA	 UL		 RCM
		 EG-Konf.	<a href="#">Miscellaneous</a>

## Further information

**Information- and Downloadcenter (Catalogs, Brochures,...)**

<http://www.siemens.com/lowvoltage/catalogs>

**Industry Mall (Online ordering system)**

<https://mall.industry.siemens.com/mall/en/en/Catalog/product?mlfb=3VA9137-0LF10>

**Service&Support (Manuals, Certificates, Characteristics, FAQs,...)**

<https://support.industry.siemens.com/cs/ww/en/ps/3VA9137-0LF10>

**Image database (product images, 2D dimension drawings, 3D models, device circuit diagrams, ...)**

[http://www.automation.siemens.com/bilddb/cax\\_en.aspx?mlfb=3VA9137-0LF10](http://www.automation.siemens.com/bilddb/cax_en.aspx?mlfb=3VA9137-0LF10)

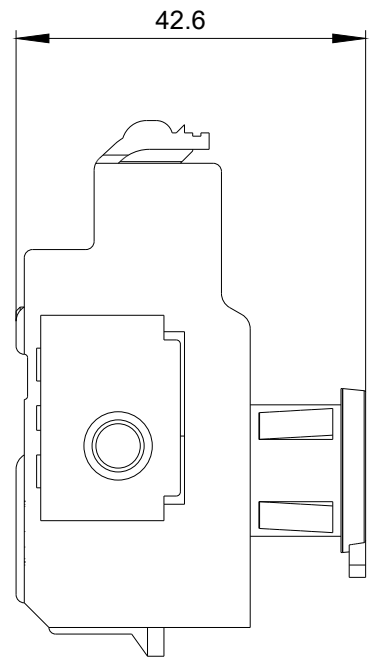
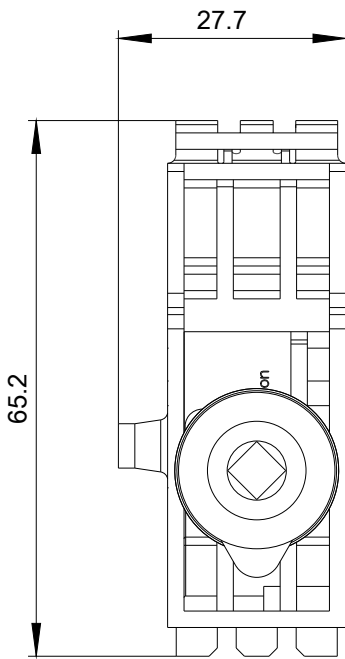

**last modified:**

08/28/2017