

Click [here](#) for production status of specific part numbers.

MAX1730xX/MAX1730xG/ MAX1731xX/MAX1731xG Evaluation Kits

Evaluates: MAX17301-MAX17303/
MAX17311-MAX17313

General Description

The MAX173xxX/MAX173xxG evaluation kits (EV kits) are fully assembled and tested surface-mount PCBs that evaluate the stand-alone pack-side fuel gauge IC with protector and SHA-256 authentication for 1-cell lithium-ion/polymer batteries.

The EV kits include the IC evaluation board with integrated I²C/1-Wire™ interface and USB micro-B cable. Windows®-based graphical user interface (GUI) software is available for use with the EV kits and can be downloaded from Maxim's website at www.maximintegrated.com/products/MAX17303 (under the *Design Resources* tab). Windows 7 or newer Windows operating system is required to use with the EV kit GUI software.

Features and Benefits

- ModelGauge™ m5 Algorithm
- Monitors Single-Cell Packs
- Full Protection Solution On-Board for Evaluation
- Battery Pack Input Voltage Range of +2.3V to +4.9V with Default Hardware
- Default Current Range -5A to +5A, up to 10A with less than 5mΩ Sense Resistor
- Thermistor Measurement Network
- On-Board I²C/1-Wire Communication Interface
- Windows 7 or Newer Compatible Software
- Proven PCB Layout
- Fully Assembled and Tested

[Ordering Information](#) appears at end of data sheet.

MAX173xx EV Kit Files

FILE	DESCRIPTION
MAX17301_03_11_13KEVKitGUISetup.msi	Installs all EV kit files on your computer

1-Wire is a registered trademark of Maxim Integrated Products, Inc.

Windows is a registered trademark and registered service mark of Microsoft Corporation.

ModelGauge is a trademark of Maxim Integrated Products, Inc.

Quick Start

Required Equipment

- MAX173xxX/MAX173xxG EV kit
- Lithium battery pack of desired configuration
- Battery charger
- Load circuit
- USB cable
- PC with Windows 7 or newer windows operating system and USB port

Procedure

The EV kits are fully assembled and tested. Follow the steps below to install the EV kit software, make required hardware connections, and start operation of the kits. The EV kit software can run without hardware attached. It automatically locates the hardware when connections are made. After communication is established, follow the [Detailed Description of Software](#) section to configure the IC and start evaluation.

- 1) Visit www.maximintegrated.com/products/MAX17303 under the *Design Resources* tab to download the latest version of the MAX173xx EV kit software. Save the EV kit software to a temporary folder and unpack the ZIP file.
- 2) Install the EV kit software on your computer by running the MAX17301_03_11_13KEVKitGUISetup.msi program inside the temporary folder. The program files are copied, and icons are created in the Windows **Start** menu. The software requires the .NET Framework 4.5 or later. If you are connected to the Internet, Windows automatically updates the .NET framework as needed.



MAX1730xX/MAX1730xG/
MAX1731xX/MAX1731xG
Evaluation Kits

Evaluates: MAX17301-MAX17303/
MAX17311-MAX17313

- 3) The EV kit software launches automatically after install, or alternatively, it can be launched by clicking on its icon in the Windows **Start** menu.
- 4) Make connections to the EV kit board based on cell pack configuration as shown in [Figure 1](#). The load or charger circuit can be connected at this time as well. The cell connects between the BATT+ and BATT- pads and the charger/load connects between the SYSPWR and SYSGND pads.
- 5) Connect the EV kit to a USB port on the PC using the USB cable. Press the S1 button to wake up the IC. The GUI software establishes communication automatically.
- 6) At startup, the IC defaults to EZ Configuration. If you have a custom .INI file for your application, it can be loaded at this time.

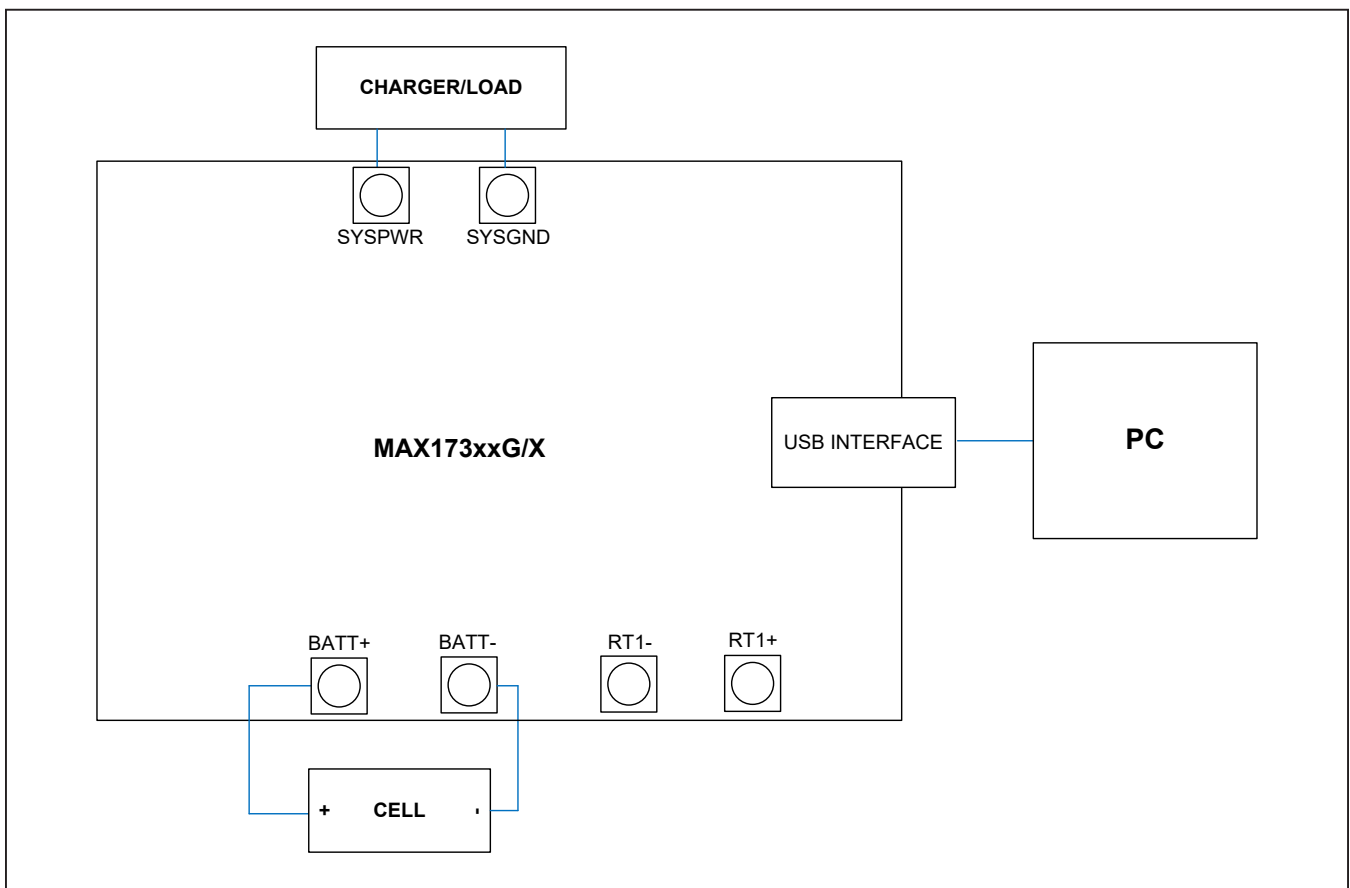

Figure 1. MAX173xx Board Connections

MAX1730xX/MAX1730xG/ MAX1731xX/MAX1731xG Evaluation Kits

Evaluates: MAX17301-MAX17303/
MAX17311-MAX17313

Detailed Description of Hardware

The MAX173xx EV kit board provides a variety of features that highlight the functionality of the IC. The following sections detail the most important aspects of the EV kit board.

Communication Connections

The USB interface on the PCB establishes I²C or 1-Wire communication between the IC and the software GUI interface. When developing code separately, connections to the communication lines can be made directly to the board SDA (DQ) and SCL (OD) pins. The user must apply the appropriate external pullup resistors to the communication lines when not using the built-in MAXUSB interface.

External Thermistor

The MAX173xx can be configured to use temperature measurements or an external thermistor. All EV kit boards come with a thermistor installed as surface mount component RT1. If the application requires direct thermal contact to the cells, RT1 can be removed and replaced with a leaded thermistor connected between the RT1+/RT1- solder pads.

Sense Resistor Options

The EV kit boards are shipped with an 0805-size IC sense resistor installed. Oversized land pattern pads allow for different size sense resistors to be used if desired.

Detailed Description of Software

The MAX173xxX/MAX173xxG evaluation kit software gives the user complete control of all functions of the MAX173xx, as well as the ability to load a custom model into the ICs. Separate control tabs allow the user access to view real-time updates of all monitored parameters. The software also incorporates a data-logging feature to monitor a cell over time.

Software Installation

The software requires a Windows 7 or newer operating system. .NET version 4.5 is required for operation and is automatically installed if an older version of the .NET framework is detected. To install the evaluation software, exit all programs currently running and unzip the provided MAX173xx installation package zipped file.

Double click the MAX17301_03_11_13KEVKitGUISetup.msi icon and the installation process begins. Follow the prompts to complete the installation. The evaluation software can be uninstalled in the **Add/Remove** programs tool in the **Control Panel**. After the installation is complete, open the Program Files (x86)\Maxim Integrated\MAX17301_03_11_13K folder and run MAX17301_03_11_13K.exe or select it from the program menu. [Figure 2](#) shows a splash screen containing information about the evaluation kit that appears while the program is loading.

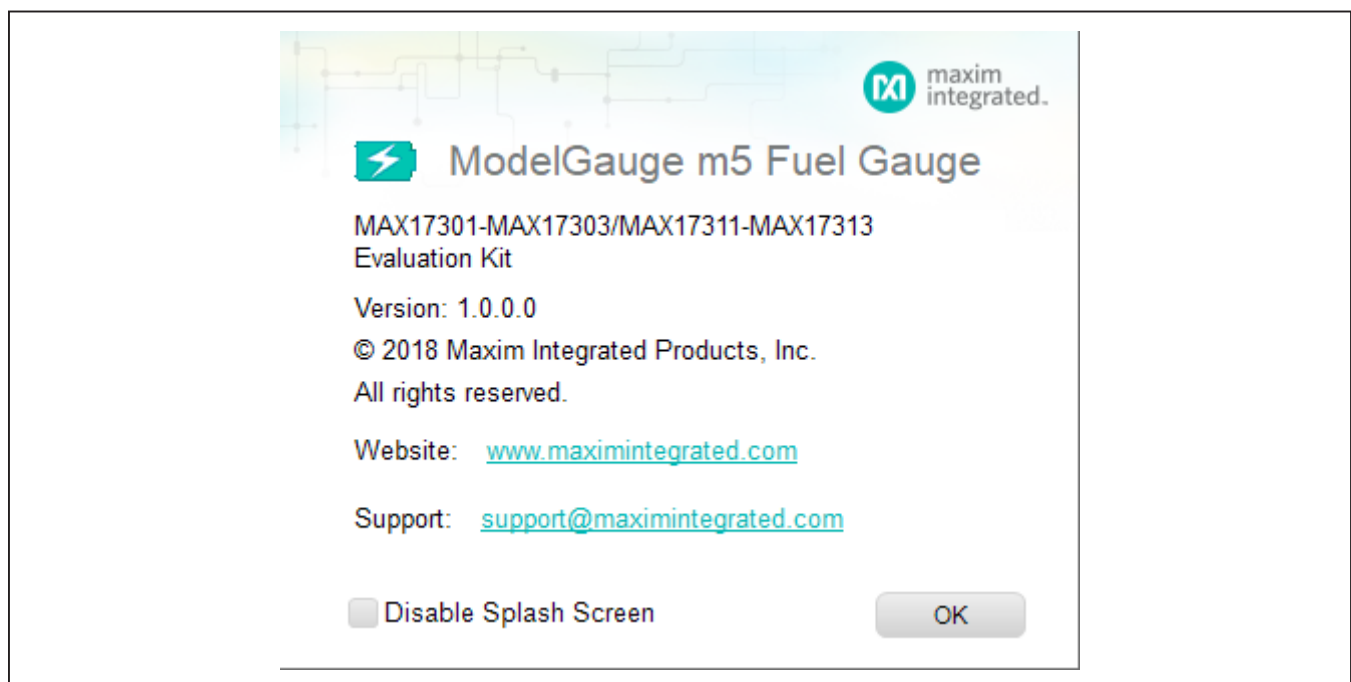

Figure 2. EV Kit Splash Screen

MAX1730xX/MAX1730xG/ MAX1731xX/MAX1731xG Evaluation Kits

Evaluates: MAX17301-MAX17303/
MAX17311-MAX17313

Communication Port

The EV kit software automatically finds the EV kit when connected to any USB port. Communication status is shown on the right-hand side of the bottom status bar. See [Figure 3](#). If the EV kit cannot be found, a “No USB Adapter” message is displayed. If the EV kit is found, but the IC cannot be found, a “No Slave Device” message is displayed. If the IC is properly powered, it can be woken up by pressing the S1 button. Otherwise, if communication is valid, a green bar updates as the software continuously reads the IC registers.

The bottom status bar also displays information on data logging status, the communication mode, hibernation status, selected current-sense resistor value, device serial number, and the EV kit GUIs version number.

Program Tabs

All functions of the program are divided under various tabs in the main program window. Click on the appropriate tab to move to the desired function page. Located on

the **ModelGauge m5** tab is the primary user information measured and calculated by the IC. The **Protector** tab displays all the protection settings of the IC. The **Graphs** tab visually displays fuel gauge and protection register changes over time. The **Registers** tab allows the user to view and modify common fuel-gauge registers one at a time. The **Commands** tab allows for special operations such as initializing the fuel-gauge logging and performing fuel-gauge reset. The **Configuration** tab allows the user to modify the NVMemory registers one at a time, but any changes here are not written to nonvolatile memory. The **Authentication** tab allows the user to send and verify the SHA commands. All tabs are described in more detail in the following sections.

ModelGauge m5 Tab

The **ModelGauge m5** tab displays the important output information read from the IC. [Figure 4](#) shows the format of the ModelGauge m5 tab. Information is grouped by function and each is detailed separately.

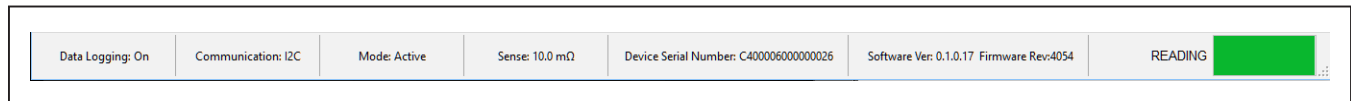

Figure 3. EV Kit Bottom Status Bar

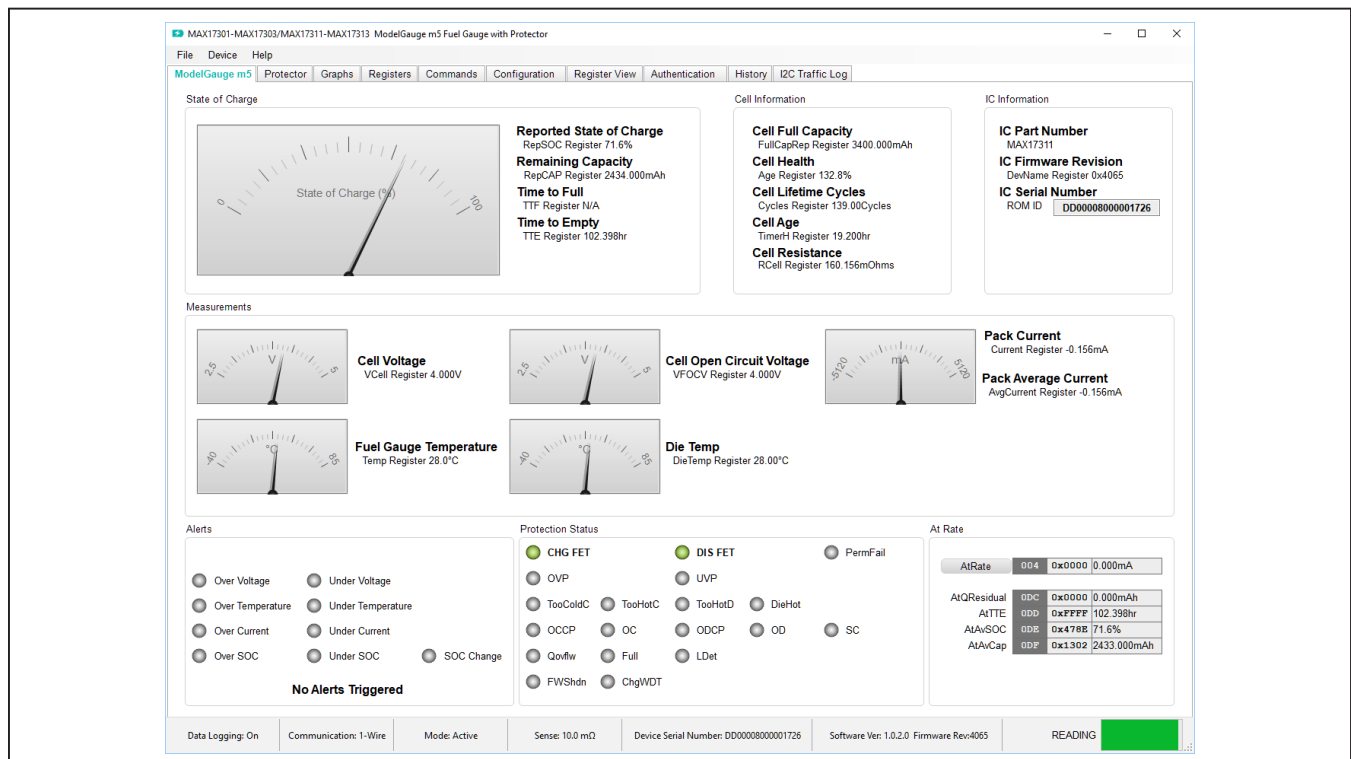

Figure 4. ModelGauge m5 Tab

MAX1730xX/MAX1730xG/ MAX1731xX/MAX1731xG Evaluation Kits

Evaluates: MAX17301-MAX17303/
MAX17311-MAX17313

State-of-Charge

The **State-of-Charge** group box displays the main output information from the fuel gauge: state-of-charge of the cell, remaining capacity, time-to-full, and time-to-empty.

Cell Information

The **Cell Information** group box displays information related to the health of the cell such as the cell's age, internal resistance, present capacity, number of equivalent full cycles, and change in capacity from when it was new.

Measurements

The **Measurements** group box displays ADC measurements that are used by the fuel gauge to determine state-of-charge.

Alerts

The **Alerts** group box tracks all possible alert trigger conditions. If any alert occurs, the corresponding LED becomes green for the user to see. The “clear alerts” button resets all alert flags.

Protection Status

The **Protection Status** group box displays the status of the charge and discharge FETs as well as all bits of the ProtStatus register. If the FETs LED is green, current can flow. If the LED is red, there is a fault condition and the FET is open preventing current flow.

At Rate

The **At Rate** group box allows the user to input a hypothetical load current (AtRate) and the fuel gauge calculates the corresponding hypothetical Qresidual, TTE, AvSOC, and AvCap values.

Protector Tab

The **Protector** tab displays the protection settings read from the IC. The settings cannot be changed from this tab. Use the **Configuration Wizard** to update these settings. [Figure 5](#) shows the format of the **Protector** tab. Information is grouped by function and each is detailed separately.

The **Measurements**, **Alerts**, and **Protection Status** group boxes display the same information that is shown on the **ModelGauge m5** tab.

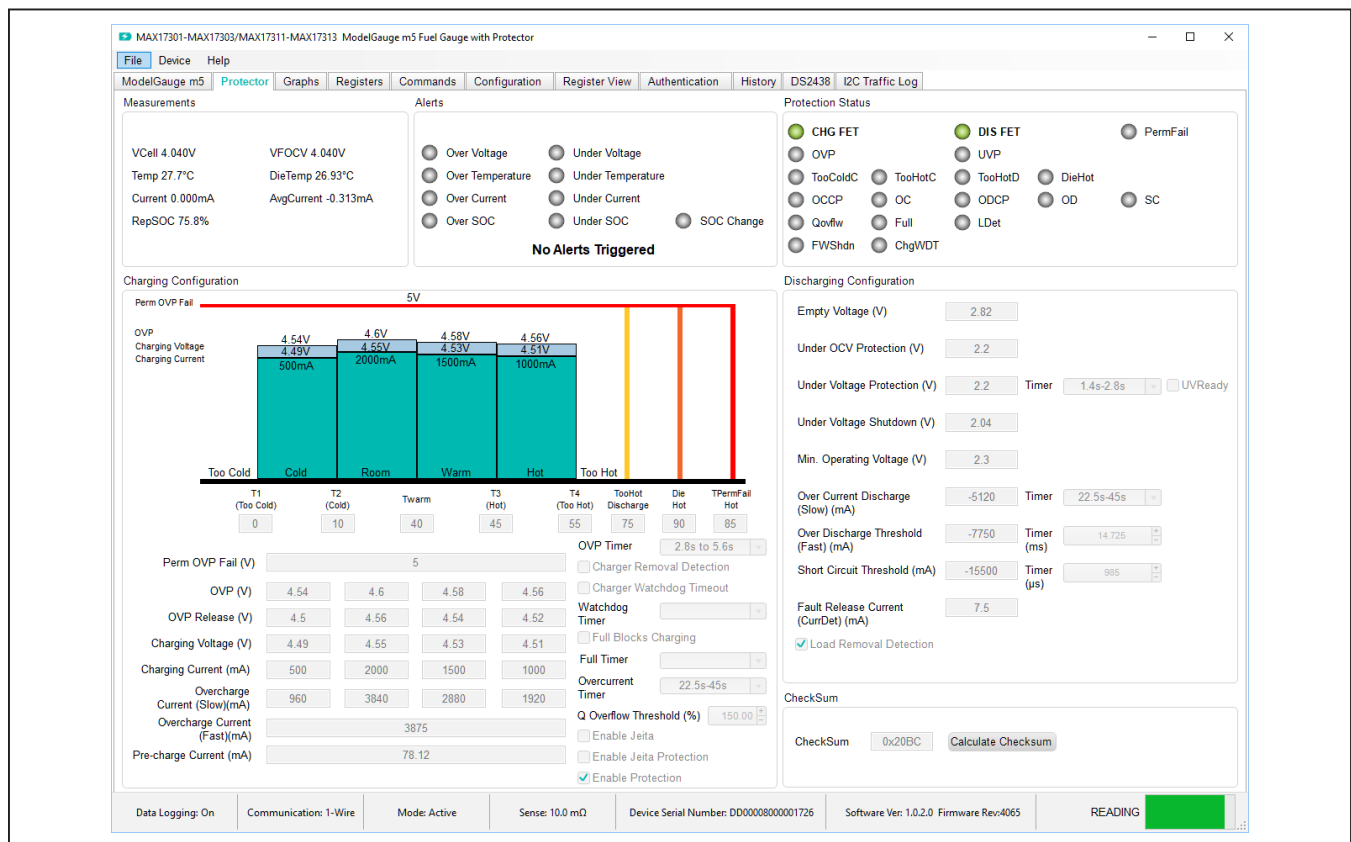

Figure 5. Protector Tab

MAX1730xX/MAX1730xG/ MAX1731xX/MAX1731xG Evaluation Kits

Evaluates: MAX17301-MAX17303/
MAX17311-MAX17313

Charging Configuration

The **Charging Configuration** group box displays all the protection settings related to charging as well as a graphical view for those selections across the programmable temperature ranges.

Discharging Configuration

The **Discharging Configuration** group box displays all the protection settings related to discharging.

Graphs Tab

Figure 6 shows the format of the **Graphs** tab. Graph information is grouped into four categories: voltages,

temperatures, capacities, and currents. The user can turn on or off any data series using the check boxes on the right-hand side of the tab. The graphs visible viewing area can be adjusted from 10 minutes up to 1 week. The graphs remember up to 1 weeks' worth of data. If the viewing area is smaller than the time range of the data already collected, the scroll bar below the graphs can be used to scroll through graph history. All graph history information is maintained by the program. Graph settings can be changed at any time without losing data. Voltages in the graph are plotted as an average cell voltage measurement.

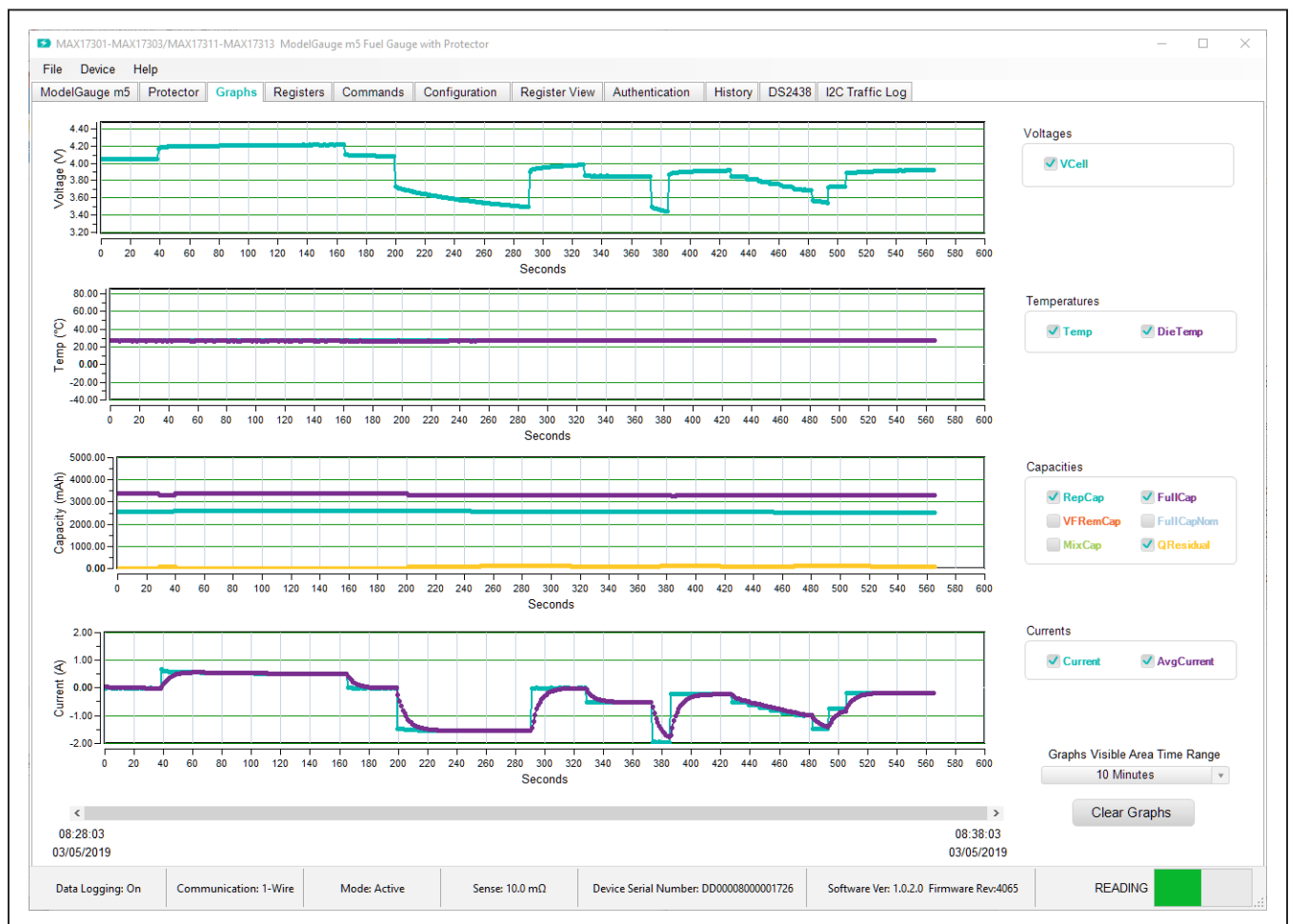

Figure 6. Graphs Tab

MAX1730xX/MAX1730xG/ MAX1731xX/MAX1731xG Evaluation Kits

Evaluates: MAX17301-MAX17303/
MAX17311-MAX17313

Registers Tab

The **Registers** tab allows the user access to all fuel gauge related registers of the IC. [Figure 7](#) shows the format of the **Registers** tab. By using the drop-down menu on the top right of the tab, the user can sort the registers either by function or by their internal address. Each line of data contains the register name, register address, hexadecimal representation of the data stored in the register, and if applicable, a conversion to application units. To write a register location, click on the button containing the register name. A pop-up window allows the user to enter a new value in either hexadecimal units or application units. The main read loop temporarily pauses while the register updates.

Commands Tab

The **Commands** tab allows the user to access any general IC function not related to normal writing and reading of register locations. [Figure 8](#) shows the format of the **Commands** tab. Each group box of the **Commands** tab is described in detail in the following sections.

1-Wire Communication Speed

This option affects 1-Wire ICs only. The user can select either standard or overdrive communication speed. Communication speed is controlled by the EV kit software by driving the OD pin of the IC high or low. Regardless of the desired communication rate, the kit software communicates with any IC it discovers at either communication speed. The actual communication speed is displayed in the bottom status bar of the EV kit window.

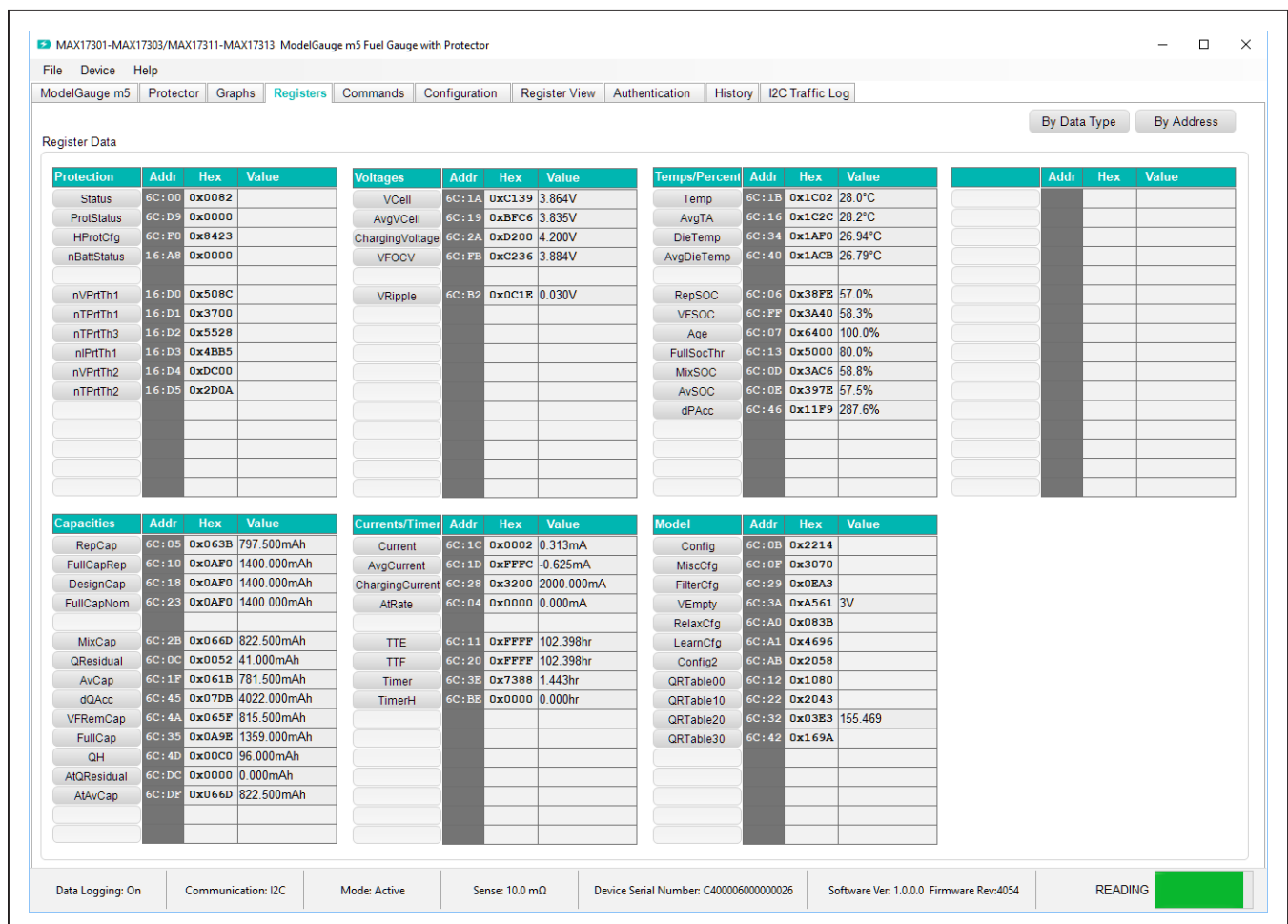

Figure 7. Registers Tab

MAX1730xX/MAX1730xG/ MAX1731xX/MAX1731xG Evaluation Kits

Evaluates: MAX17301-MAX17303/
MAX17311-MAX17313

Read/Write Register

The user can read a single register location by entering the address in hex and clicking the **Read** button. The user can write a single register location by entering the address and data in hex and clicking the **Write** button. The read loop is temporarily paused each time to complete this action.

Log Data to File

Data logging is always active when the EV kit software is started. The default data log storage location is My Documents/Maxim Integrated/MAX17301_03_11_13/Datalog.csv. The user can stop data logging by clicking the **Stop Log** button or change the data log file name by clicking the **Change Path** button. Whenever data logging is active, it is displayed on the bottom status bar of the EV kit window. All user available IC registers are logging in a .csv formatted file. The user can adjust the logging interval at any time. The user can also enable or disable the event logging at any time. When event logging is enabled, the data log also stores any IC write or reads that are not a part of the normal read data loop and indicates any time communication to the IC is lost.

Nonvolatile Memory Block

Clicking the **Burn NV Block** button sends the Copy NV Block command to the command register that causes all register locations from 180h to 1DFh to be stored to nonvolatile memory. Nonvolatile memory has a limited number of copies and the user is prompted to confirm prior to executing the copy.

Reset IC

Clicking the **Full Reset** button sends the software POR command to the command register and sets the POR_CMD bit of the Config2 register to fully reset fuel-gauge operation as if the IC had been power cycled. Note that resetting the IC when the cell is not relaxed causes fuel-gauge error.

Lock Register Blocks

Clicking one of the five lock buttons locks a page or pages of memory as listed to the right of each button. This is a permanent operation, so the user is prompted to confirm the operation prior to setting the lock.

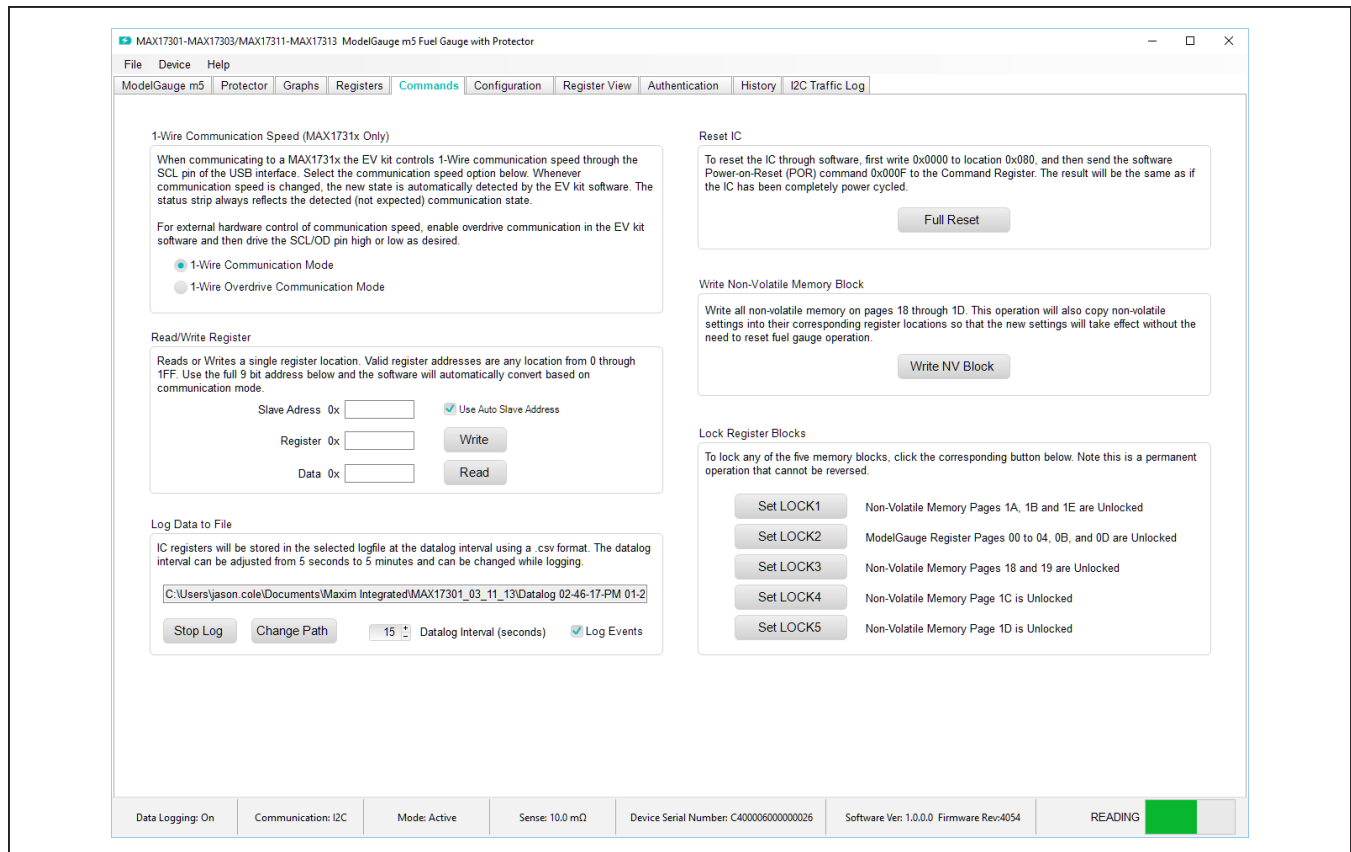

Figure 8. Commands Tab

MAX1730xX/MAX1730xG/ MAX1731xX/MAX1731xG Evaluation Kits

Evaluates: MAX17301-MAX17303/
MAX17311-MAX17313

Configuration Tab

The **Configuration** tab has similar formatting to the standard **Registers** tab as shown in [Figure 9](#), but there are some major differences. When the user changes a register value on the **Configuration** tab, only the RAM value of that location is changed. The nonvolatile value remains unchanged. Register text changes to **BLUE** to indicate the RAM and nonvolatile values do not match. The user must complete a nonvolatile burn on the **Commands** tab or run the **Configuration Wizard** to change the nonvolatile value. The nonvolatile memory has a limited number

of updates that is shown in a box on the left-hand side of the tab. Maxim recommends using the **Configuration Wizard** to make any changes to nonvolatile memory instead of changing registers manually. The wizard can be launched through the **Device** drop-down menu at the top of the EV kit software window or by the button on the top-right of the **Configuration** tab. See the [Configuration Wizard](#) section for details. Note any register information that is displayed in **RED** text indicates a nonvolatile write error where the data read back after a nonvolatile memory write does not match the expected value.

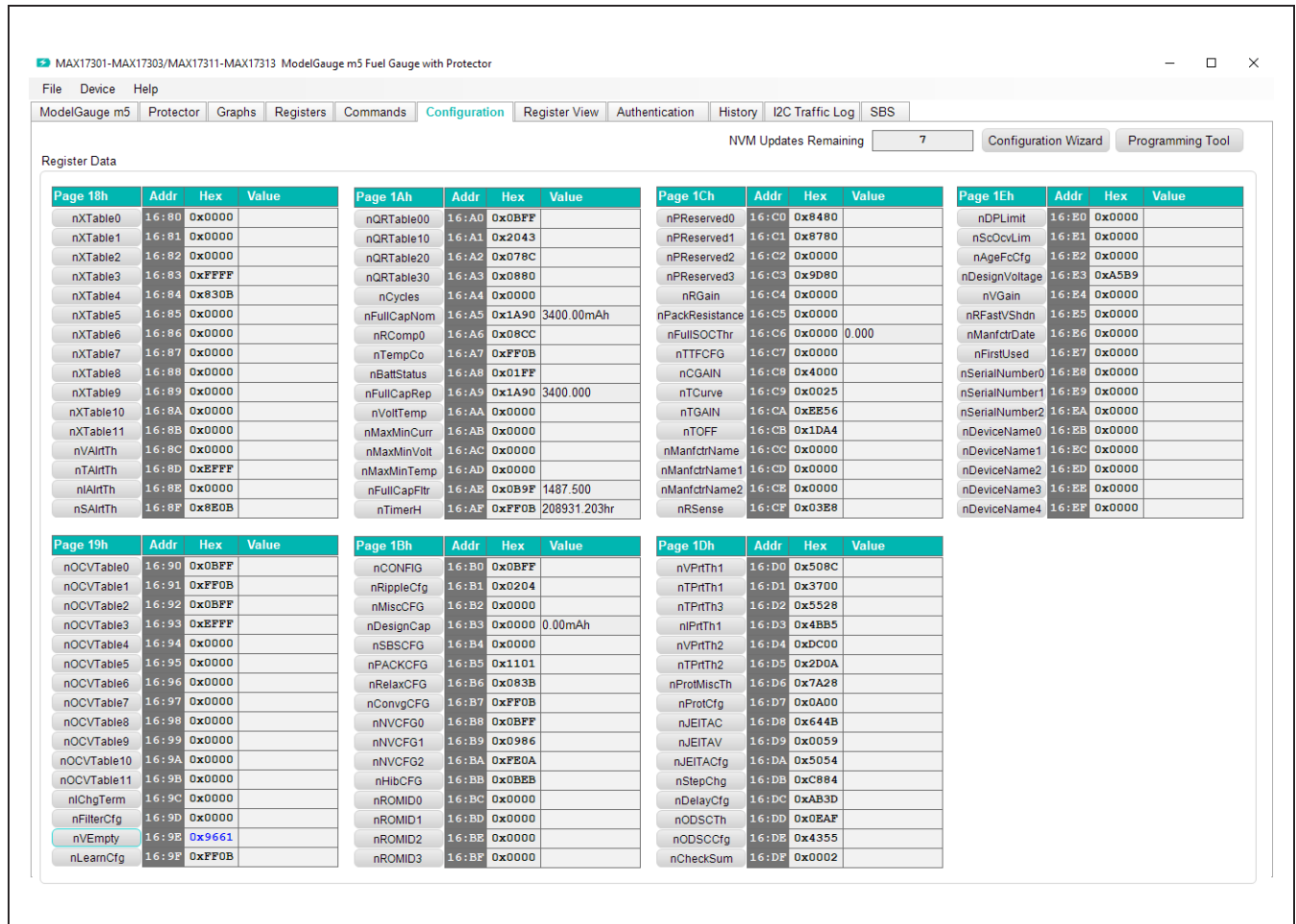

Figure 9. Configuration Tab

MAX1730xX/MAX1730xG/ MAX1731xX/MAX1731xG Evaluation Kits

Evaluates: MAX17301-MAX17303/
MAX17311-MAX17313

Register View Tab

The **Register View** tab provides a convenient interface to visualize and update the register settings in binary format. As shown in [Figure 10](#), all configuration register names are listed on the left side of the **Register View** tab. When one register is selected, detailed information about the register is displayed on the right-side panel. The corresponding name and binary value of each bitfield of the selected register are displayed on the top table. Clicking the **Read Register** button refreshes the view and loads the register reading into the top table. Single click the binary bitfield to edit the register setting directly. When all the desired bitfield settings are updated, click the **Write Register** button to update the register value. If the change needs to be aborted, click the **Read Register** button to reload the register value. The table on the bot-

tom right lists all the bit descriptions and reset values based on the IC data sheet. Refer to the description of the bitfield for how to set the bitfield. The **Find: Bit Fields** feature is located at the bottom left of the **Register View** tab. To find a bitfield, type in the bitfield name in the **Find: Bit Fields** menu bar. The search result is available in the dropdown list. The **History** menu at the bottom left shows all the history searches from the **Find: Bit Fields** menu.

Authentication Tab

The **Authentication** tab allows for full evaluation of the SHA-256 battery security feature for MAX17301/MAX17311 and MAX17302/MAX17312 fuel gauges. This battery authentication feature is not available for MAX17303/MAX17313. [Figure 11](#) shows the **Authentication** tab. Each group box of the **Authentication** tab is described in detail in the following sections.

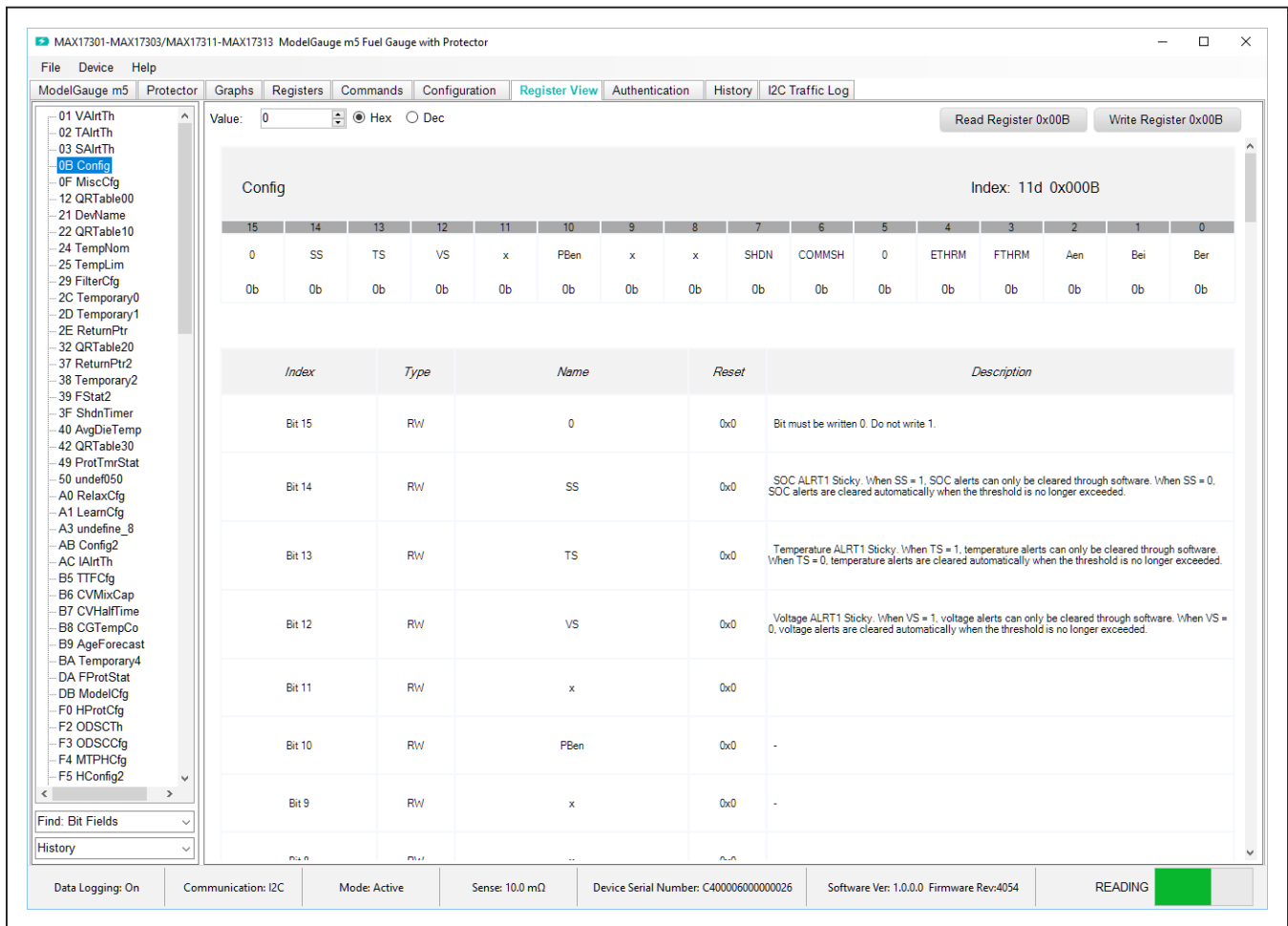

Figure 10. Register View Tab

MAX1730xX/MAX1730xG/ MAX1731xX/MAX1731xG Evaluation Kits

Evaluates: MAX17301-MAX17303/
MAX17311-MAX17313

SHA Challenge/ROM ID

The 160-bit SHA-256 Challenge message consists of ten 16-bit challenges. To manually enter the challenge message, click the hex value field of each challenge number and edit the value in the text box. Click the **Randomize Challenge** button to create a random challenge message.

SHA Secret

The 160-bit SHA-256 Secret key consists of ten 16-bit secret values. Unless the secret is specifically programmed by Maxim Integrated, the default key value is 0. To prepare for authentication with the IC, enter the known secret value for the IC connected to the GUI. Click **Clear Secret** to reset the key values in the IC to 0. Note that it is not possible to clear secret if secret is locked. Click **Lock Secret** to permanently lock the secret value for the IC. **Secret Changes Remaining** shows the remaining chances to update SHA secret value.

Authentication Result

This group box provides four methods to perform authentication evaluation. When the authentication process begins, the IC calculates MAC based on the challenge and stored secret value. The GUI, which represent the host-side processor, also calculates based on challenge and known secret. If the SHA secret is entered correctly matching the programmed secret state in the IC, the authentication succeeds given any challenge using any of the four methods. **Compute MAC with ROM ID** computes MAC result based on IC ROM ID that is specific to the IC. **Compute MAC without ROM ID** does not involve ROM ID into computation, which means the MAC result for every IC given the same challenge and secret should be the same. **Compute Next Secret** commands do not only compute authentication results, but also updates the secret value [Secret0...Secret9] to [MAC6...MAC15]. If there is no **Secret Changes Remaining** displayed in the **SHA Secret** group or the secret is locked, the secret does not update.

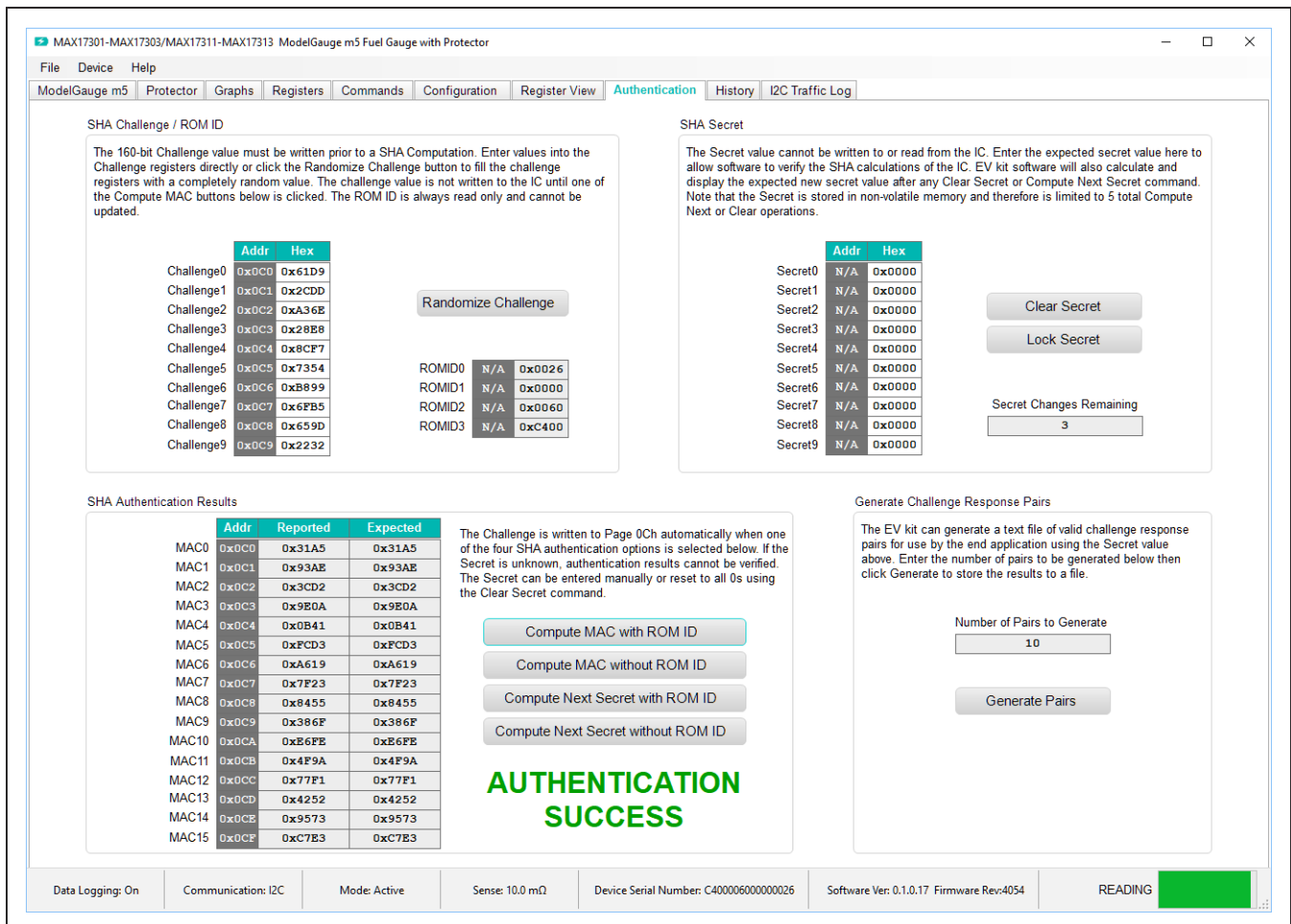

Figure 11. Authentication Tab

MAX1730xX/MAX1730xG/ MAX1731xX/MAX1731xG Evaluation Kits

Evaluates: MAX17301-MAX17303/
MAX17311-MAX17313

History Tab

The **History** tab visualizes all nonvolatile update history on 0x1Ax column of the nonvolatile memory map. [Figure 12](#) shows the **History** tab. This column of nonvolatile memory features a Fibonacci Saving mechanism to help the IC efficiently learn and adapt to battery characteristic changes. The column of memory is changed by nonvolatile programming and also is updated automatically as the battery pack experience through usage cycles.

In the **Read History** group box, click the **Read Battery History** button to initiate the nonvolatile history recall process. Once the process is initiated, it takes a while to load the nonvolatile history from the IC. Click the **Read Battery History and Save to File** to save the nonvolatile history to a csv file in addition to initiate the nonvolatile history recall process. After the recall process is finished, enter in the page number or select the + or – signs to browse through the nonvolatile history at the **Display History Data** tool. The detailed information of the specific page selected is displayed in the **Logging History** section.

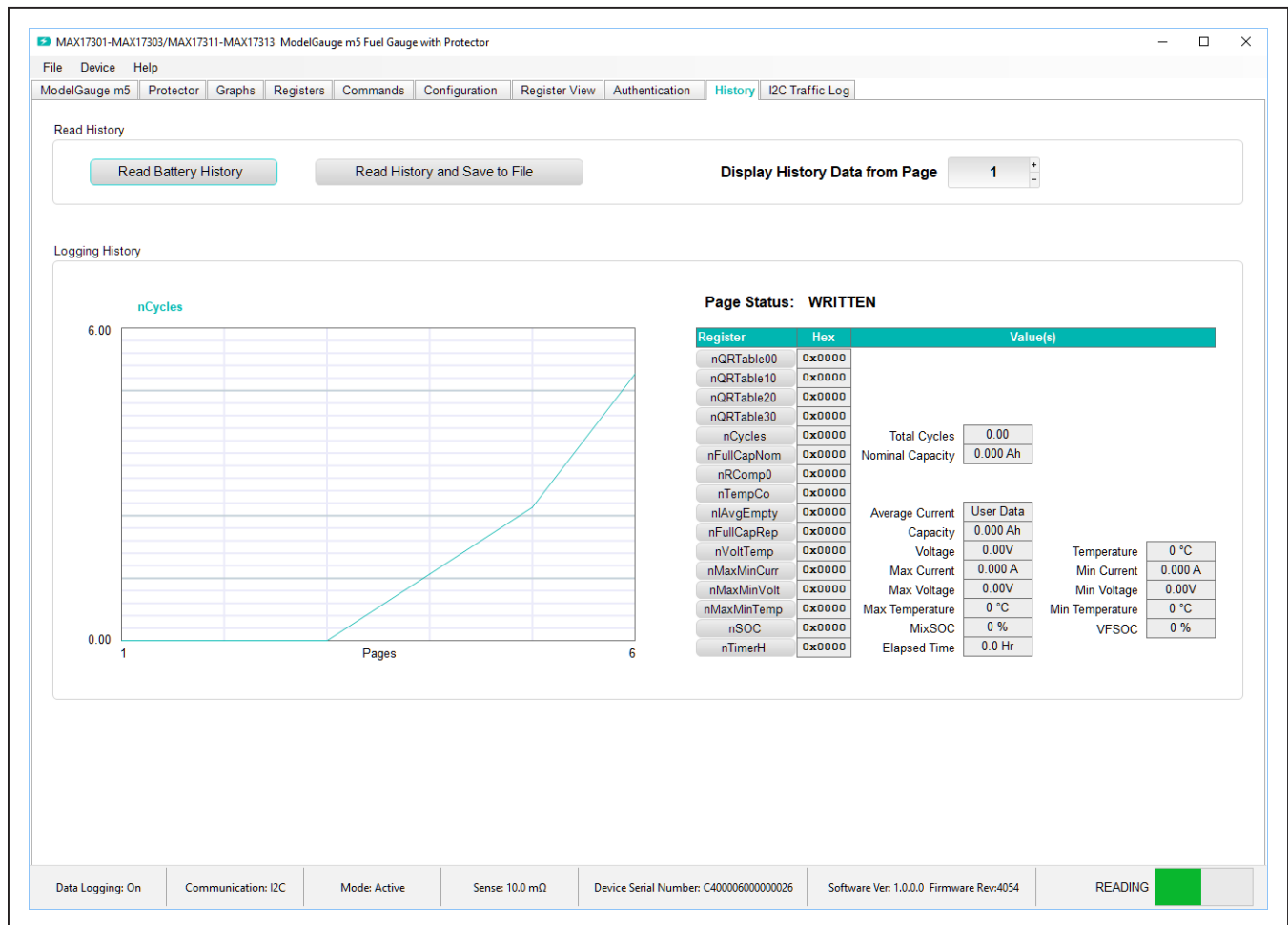

Figure 12. History Tab

MAX1730xX/MAX1730xG/ MAX1731xX/MAX1731xG Evaluation Kits

Evaluates: MAX17301-MAX17303/
MAX17311-MAX17313

Configuration Wizard

Before the IC accurately fuel gauges the battery pack, it must be configured with characterization information. This can be accomplished in two ways. The first is through a custom characterization procedure that can be performed by Maxim under certain conditions. The result is an .INI summary file that contains information that can be programmed into the IC on the **Configure** tab. Contact Maxim for details about this procedure.

The second method is ModelGauge m5 EZ configuration. This is the default characterization information shipped inside every IC. This default model produces accurate results for most applications under most operating conditions. It is the recommended method for new designs as it bypasses the custom cell characterization procedure. Some additional information is required from the user for EZ configuration initialization.

In the **Configuration** tab, click the **Configuration Wizard** button. The **Configuration Wizard** window pops up as

shown in [Figure 13](#). Follow the description and complete all the steps in the **Configuration Wizard**. Click **Next** when each step is finished.

Step 1 shows the options for how to start with nonvolatile programming. For a previously unprogrammed IC, select **Start with Factory Default Values** to begin evaluation. If there are already nonvolatile memory changes in the IC to be kept, select **Start with Existing Nonvolatile Memory Data**.

Step 2 shows the critical model selection options. Enter the sense resistor value into the **Sense (mOhms)** text box. For EZ configuration without using an INI file, select the **Use ModelGauge m5 EZ Model** option. Enter the rated battery capacity, empty voltage (minimum safe system supply voltage), charge termination current, and check the checkbox if charge voltage is greater than 4.275V. If the INI file is available, select **Use Custom Model** and load model INI file provided by Maxim directly.

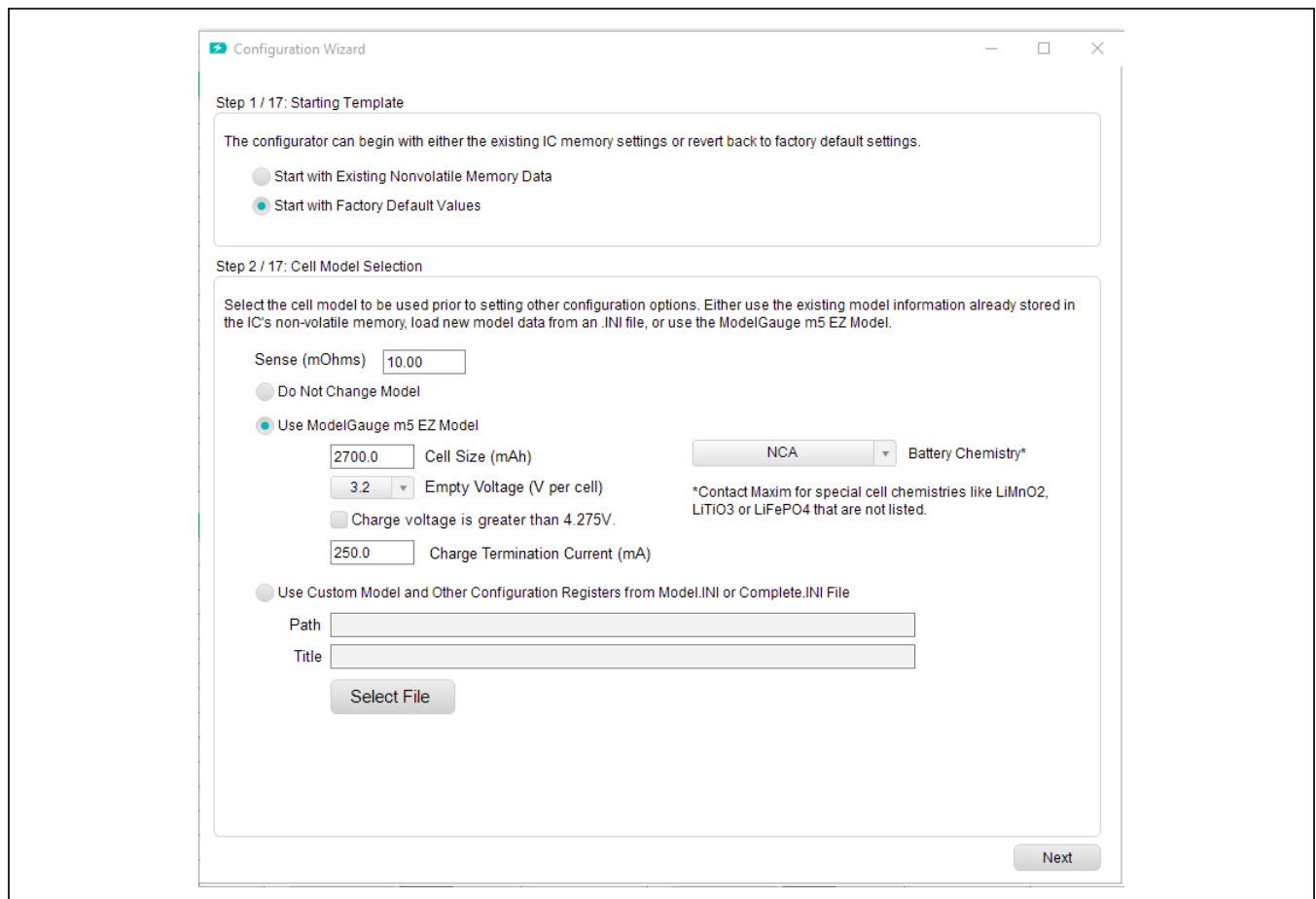

Figure 13. Configuration Wizard—Steps 1 and 2

MAX1730xX/MAX1730xG/
MAX1731xX/MAX1731xG
Evaluation Kits

Evaluates: MAX17301-MAX17303/
MAX17311-MAX17313

In Step 3, charge protection related settings need to be configured. Figure 14 shows this step. The check-boxes at the bottom right enable or disable the protection features. The **Enable Protection** feature needs to be checked to enable protection. JEITA charging allows the IC to calculate and report the required charging voltage and charging current base on temperature conditions. If the JEITA charging feature is desired, check the **Enable JEITA** checkbox. JEITA protection allows the IC to protect

charging at different charging rates based on temperature conditions. Check the **Enable JEITA Protection** to enable this feature. The upper section of the panel visualizes the JEITA temperature zones and protection thresholds. In the lower section, the user can edit detailed settings like the temperature zone, OVP, charging voltage, and charging current. When all the JEITA settings are completed, check the upper section graph to make sure settings are correct.

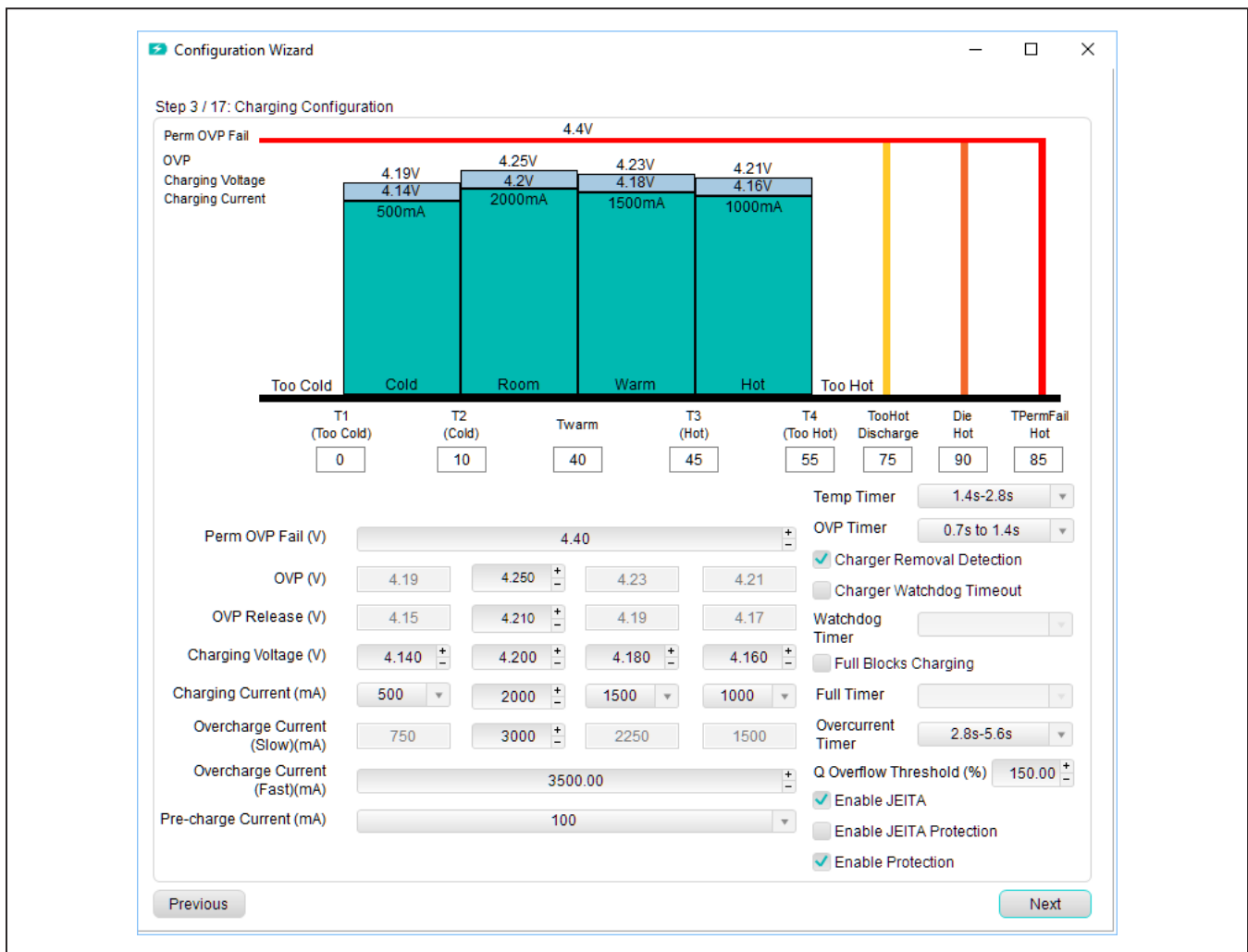

Figure 14. Configuration Wizard—Step 3

MAX1730xX/MAX1730xG/ MAX1731xX/MAX1731xG Evaluation Kits

Evaluates: MAX17301-MAX17303/
MAX17311-MAX17313

From Step 4 to Step 5, the user can edit the discharge protection parameters. See [Figure 15](#) and [Figure 16](#). The parameters include detailed protection configurations, thresholds, and timings. In Step 6, choose the power mode for fuel-gauge device. Enabling hibernate mode allows the reduction of consumption by 6µA in operating mode, with lower rate of ADC sampling. Enabling Deepship mode shuts down any protection functionality during shipping and storage conditions. In Step 7, check the “Battery Out” option to allow the communication stop

shutdown feature. Check “Pushbutton Wakeup” to allow wakeup fuel-gauge from the ALRT pin.

From Steps 8 to 16, follow along the step description to fill out all the application specific information related to fuel-gauging. Typically, leave options from Steps 8 to 16 as default. If there is a special thermistor requirement, look for the NTC model with the closest Beta value in the drop-down list. If the thermistor beta value is not covered by the models in the drop-down list, contact Maxim for support.

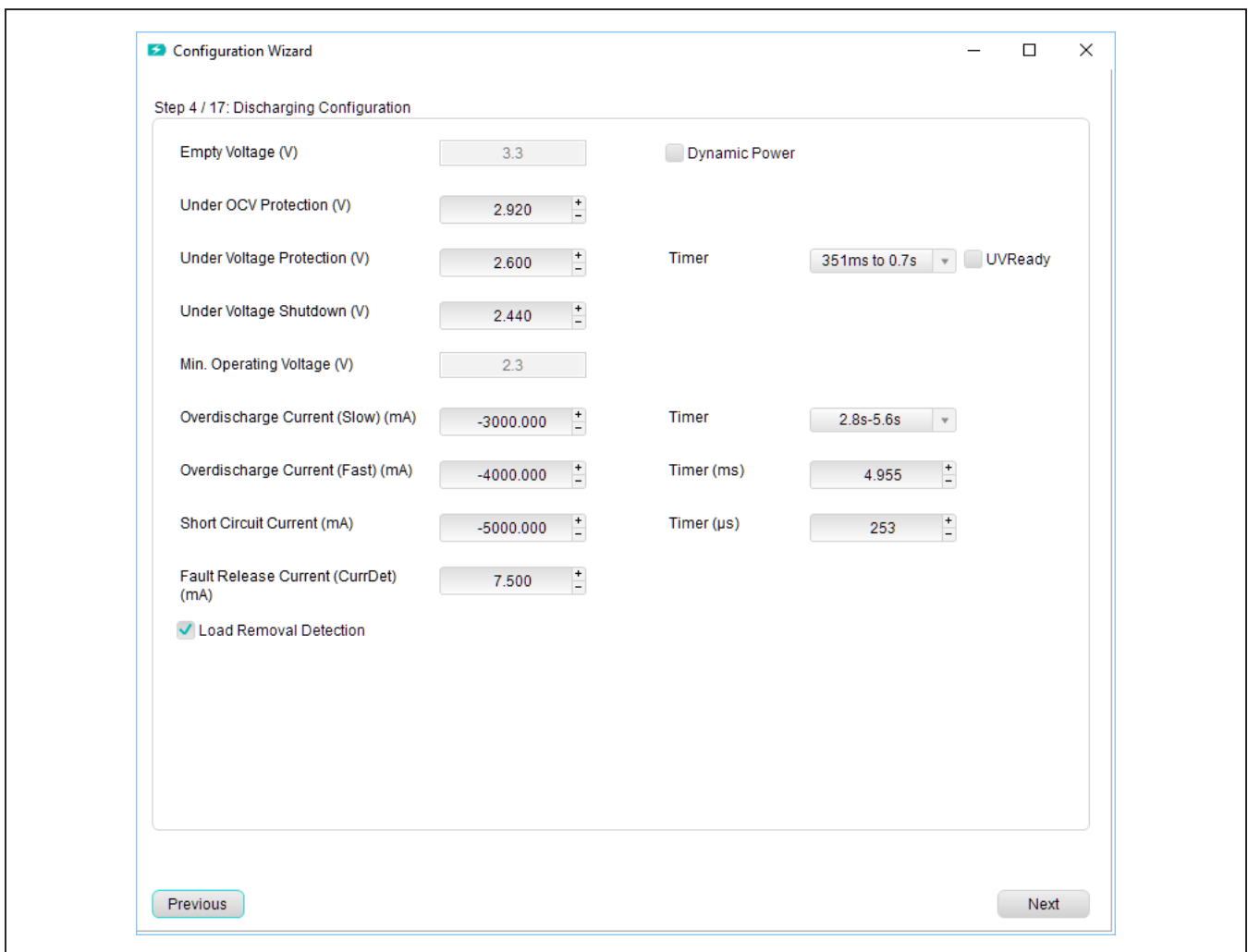

Figure 15. Discharge Protection Configurations

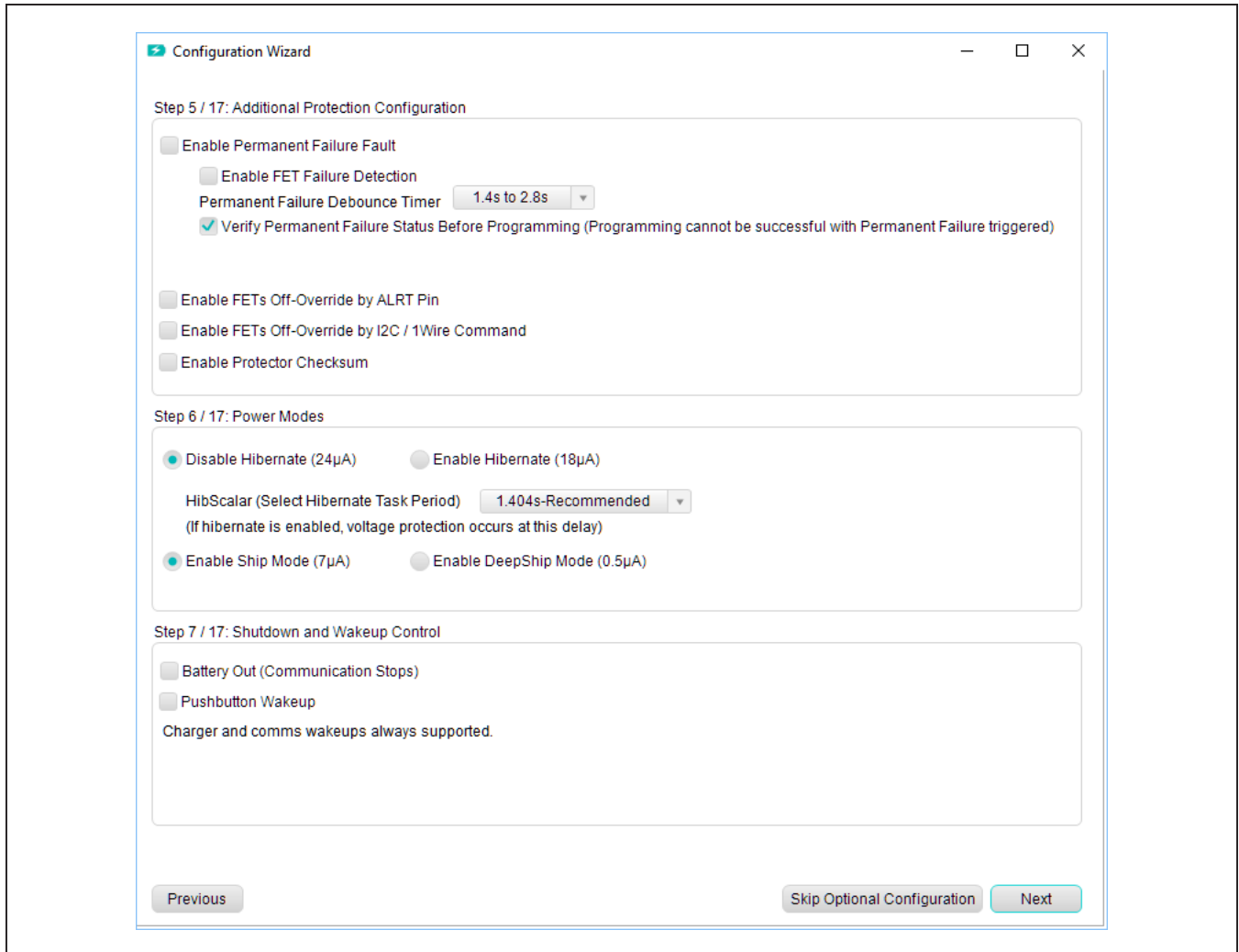

Figure 16. Additional Protection Configuration and Power Mode Control

MAX1730xX/MAX1730xG/ MAX1731xX/MAX1731xG Evaluation Kits

Evaluates: MAX17301-MAX17303/
MAX17311-MAX17313

In Step 17, the user can choose to update the IC based on previous configuration steps. See [Figure 17](#). The non-volatile memory can only be updated seven times. The user can choose to update only the RAM by selecting the second option. This is a good method to evaluate previous settings without updating the nonvolatile memory. In this mode, if the IC is power cycled, the configuration is lost. If final configuration is decided, choose the third option **Write New Configuration to Non-volatile Memory**.

Always remember to check **Save New Configuration Settings to .INI file**. This allows the resulting configuration in previous steps to be recorded in a final INI file. When the **Configuration Wizard** is closed, the previous configurations are not remembered. Click the **Update IC** button to execute the changes and saves. Click the **Close** button to exit the **Configuration Wizard** without doing anything.

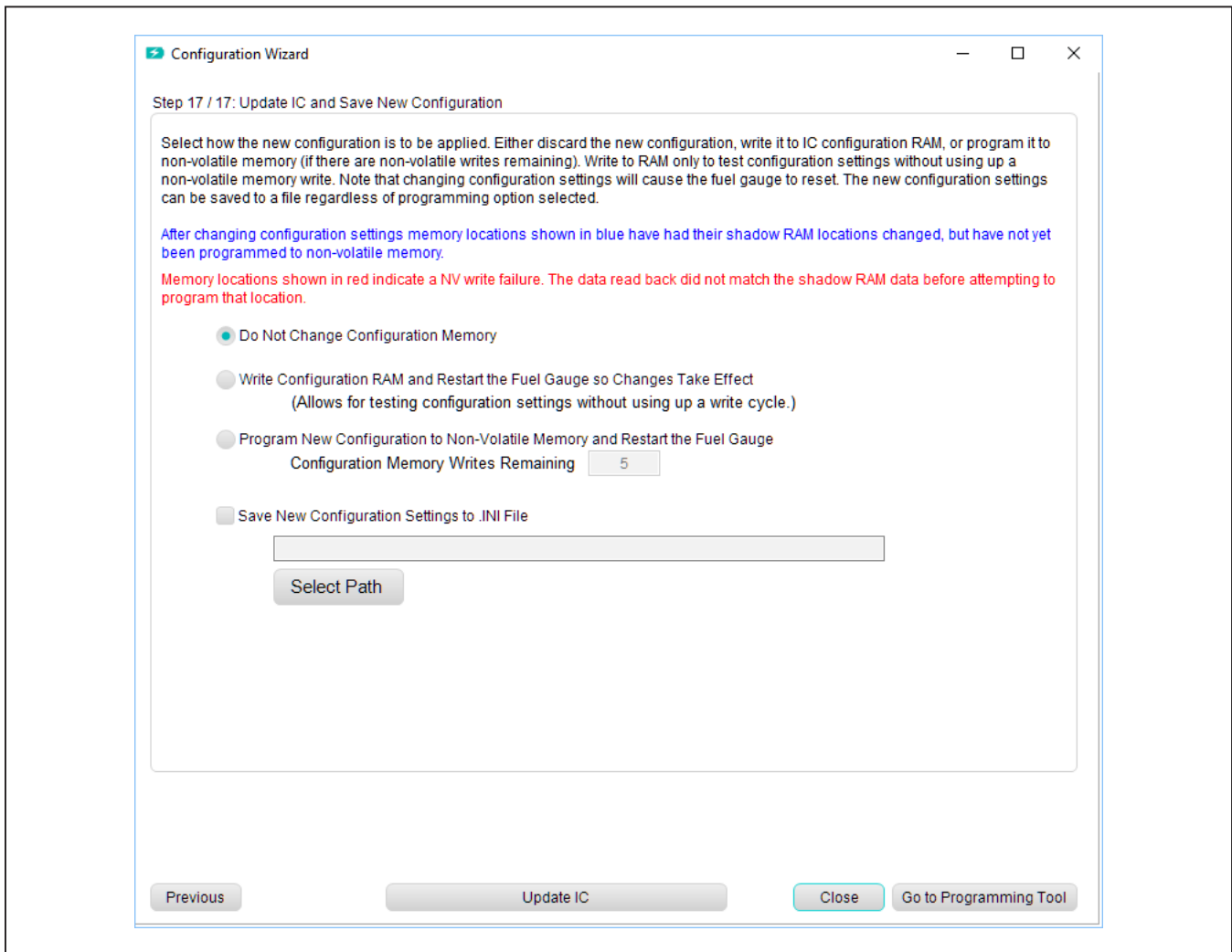

Figure 17. Configuration Step

MAX1730xX/MAX1730xG/
MAX1731xX/MAX1731xG
Evaluation Kits

Evaluates: MAX17301-MAX17303/
MAX17311-MAX17313

Programming Tool

The INI file provided from Maxim only includes the battery characteristics model. See [Figure 18](#). It does not include custom settings for protector and device operation. After completion of the **Configuration Wizard**, a full INI is generated with all nonvolatile register configurations. With a full INI, the user does not need to go through the **Configuration Wizard** again. In the **Programming Tool**

panel, click **Select File** to select the saved full configuration file. The configuration file is typically saved from the configuration step in the **Configuration Wizard** as shown in [Figure 17](#). Click **Program IC** to program nonvolatile memory directly. When there is a minor change required on one or two nonvolatile registers, edit the registers inside the final configuration INI file using a text editor, then program the IC using the programming tool.

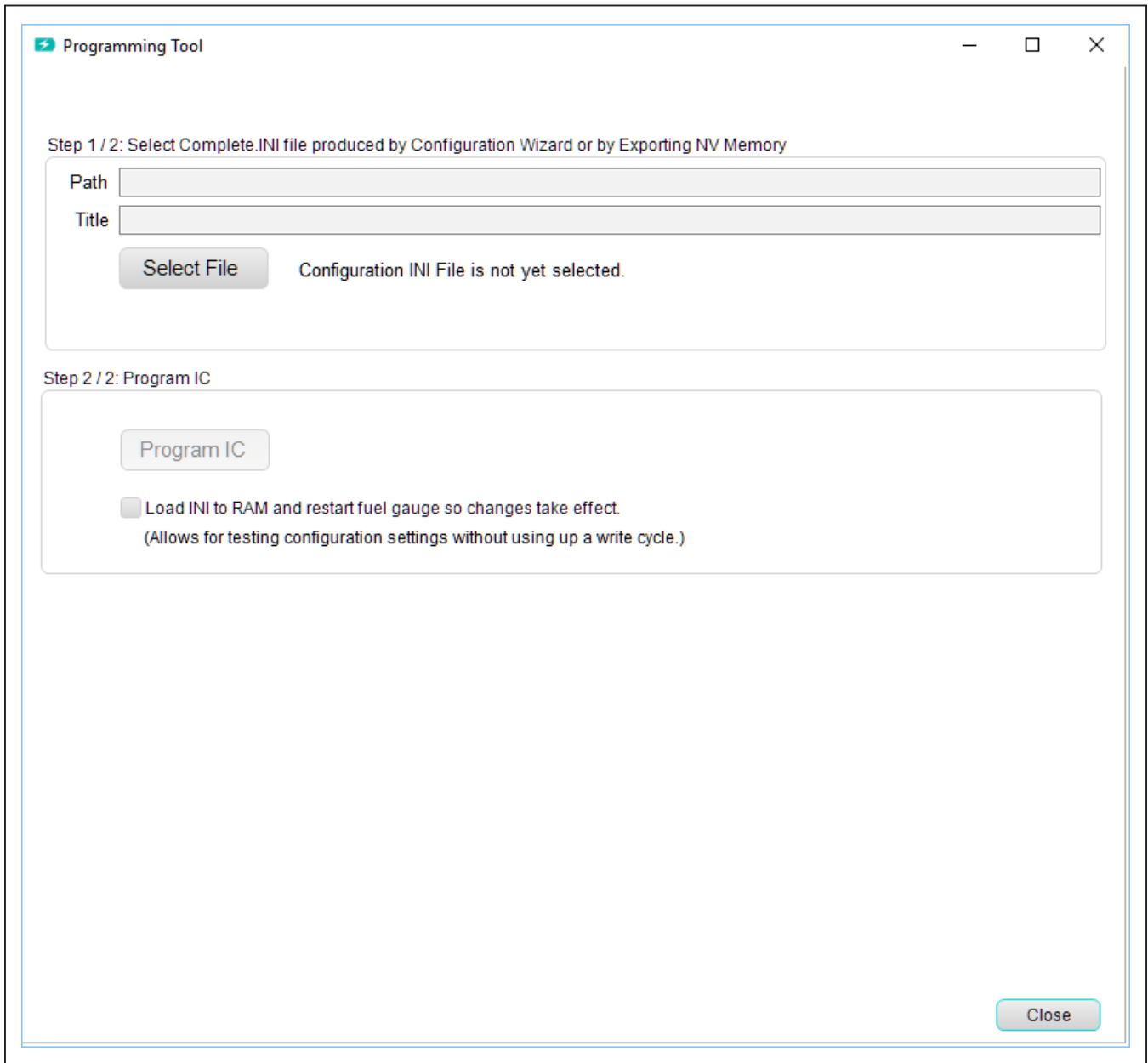

Figure 18. Programming Tool

MAX1730xX/MAX1730xG/ MAX1731xX/MAX1731xG Evaluation Kits

Hardware Connection Guideline

When evaluating the MAX173xx EV kit with high current or evaluating the protection functionality, use a real battery instead of power supply. When connecting a battery, use a soldered connection instead of a jumper cable. During a protector FET switching event, the inductance of the lab jumper cable and power supply can cause a voltage overshoot on the battery. This voltage spike

Evaluates: MAX17301-MAX17303/
MAX17311-MAX17313

could potentially cause the voltage across the BATT and GND pins to rise above the absolute maximum rating of 6V, damaging the IC permanently. [Figure 19](#) and [Figure 20](#) show good examples of battery connections and its corresponding BATT voltage waveform during switching events. [Figure 21](#) and [Figure 22](#) show bad examples of battery connections and its corresponding BATT voltage waveform.

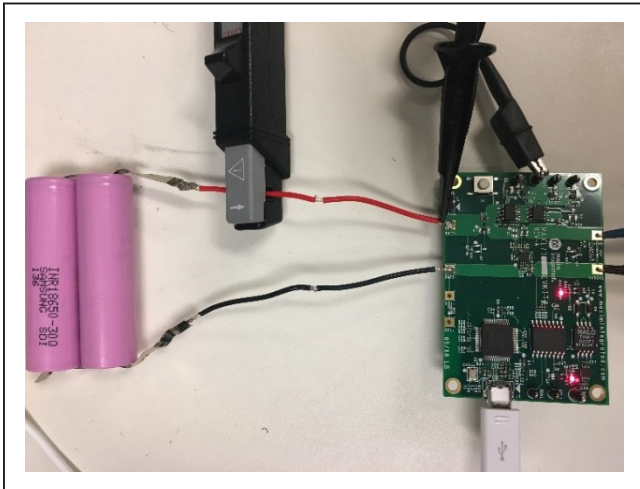

Figure 19. Good Hardware Connection Example (Use real battery and soldered connection.)

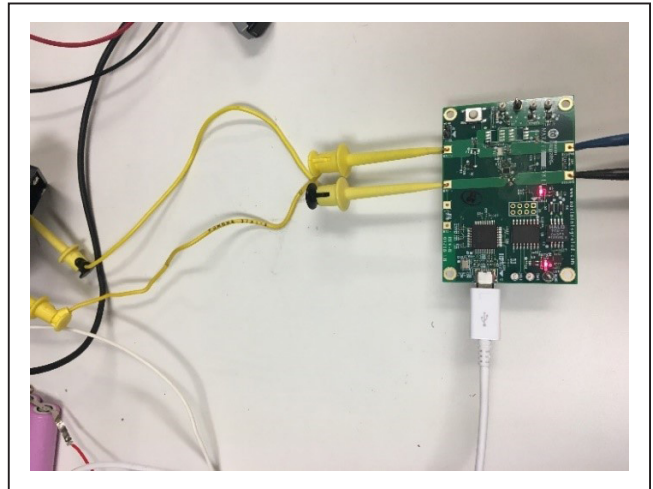

Figure 21. Bad Hardware Connection Example (Use power supply with lab jumper cable.)

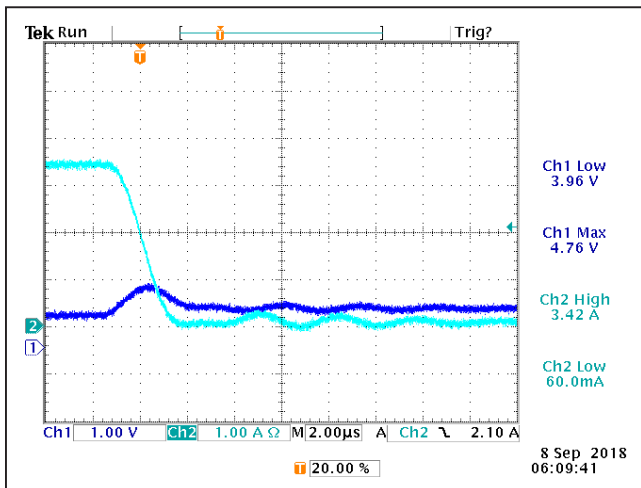

Figure 20. BATT Voltage and Battery Current Waveform at Overcurrent Protection Event with Good Connections

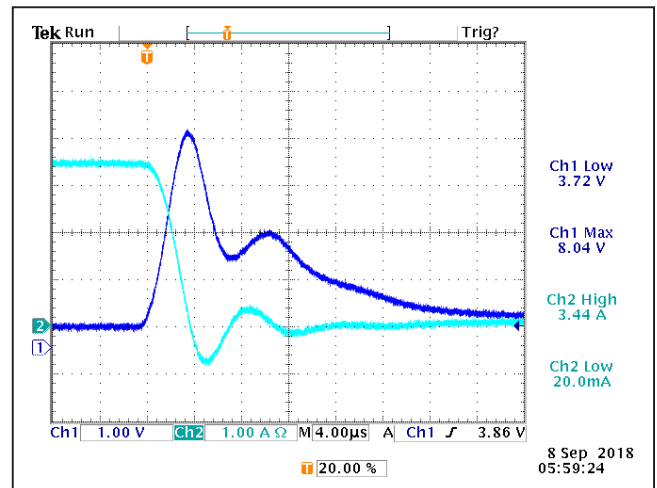

Figure 22. BATT Voltage and Battery Current Waveform at Overcurrent Protection Event with Bad Connections

MAX1730xX/MAX1730xG/
MAX1731xX/MAX1731xG
Evaluation Kits

Evaluates: MAX17301-MAX17303/
MAX17311-MAX17313

Component Suppliers

SUPPLIER	PHONE	WEBSITE
Murata Electronics North America, Inc.	770-436-1300	www.murata.com/en-us
TDK Corp.	847-803-6100	www.component.tdk.com
Vishay	402-563-6866	www.vishay.com

Note: Indicate that you are using the MAX173xx when contacting these component suppliers.

Ordering Information

PART	FUEL GAUGE	PROTECTOR	AUTHENTICATION	INTERFACE	PIN-PACKAGE
MAX17301GEVKIT#*	1-Cell Fuel Gauge with ModelGauge m5 EZ	2-Level	SHA-256	I ² C	14 TDFN-EP
MAX17301XEVKIT#	1-Cell Fuel Gauge with ModelGauge m5 EZ	2-Level	SHA-256	I ² C	15 WLP
MAX17311GEVKIT#*	1-Cell Fuel Gauge with ModelGauge m5 EZ	2-Level	SHA-256	1-Wire	14 TDFN-EP
MAX17311XEVKIT#	1-Cell Fuel Gauge with ModelGauge m5 EZ	2-Level	SHA-256	1-Wire	15 WLP
MAX17302GEVKIT#*	1-Cell Fuel Gauge with ModelGauge m5 EZ	1-Level	SHA-256	I ² C	14 TDFN-EP
MAX17302XEVKIT#	1-Cell Fuel Gauge with ModelGauge m5 EZ	1-Level	SHA-256	I ² C	15 WLP
MAX17312GEVKIT#*	1-Cell Fuel Gauge with ModelGauge m5 EZ	1-Level	SHA-256	1-Wire	14 TDFN-EP
MAX17312XEVKIT#	1-Cell Fuel Gauge with ModelGauge m5 EZ	1-Level	SHA-256	1-Wire	15 WLP
MAX17303GEVKIT#*	1-Cell Fuel Gauge with ModelGauge m5 EZ	1-Level		I ² C	14 TDFN-EP
MAX17303XEVKIT#	1-Cell Fuel Gauge with ModelGauge m5 EZ	1-Level		I ² C	15 WLP
MAX17313GEVKIT#*	1-Cell Fuel Gauge with ModelGauge m5 EZ	1-Level		1-Wire	14 TDFN-EP
MAX17313XEVKIT#	1-Cell Fuel Gauge with ModelGauge m5 EZ	1-Level		1-Wire	15 WLP

#Denotes RoHS compliance.

*Future product—contact factory for availability.

MAX1730xX/MAX1730xG/
MAX1731xX/MAX1731xG
Evaluation Kits

Evaluates: MAX17301-MAX17303/
MAX17311-MAX17313

MAX173xxG EV Kit Bill of Materials

REF DES	DNI/DNP	QTY	MFG PART #	MANUFACTURER	VALUE	DESCRIPTION
ALRT, SCL, SCL1, SDA, SDA1	-	5	5002	KEYSTONE	N/A	TEST POINT; PIN DIA=0.1IN; TOTAL LENGTH=0.3IN; BOARD HOLE=0.04IN; WHITE; PHOSPHOR BRONZE WIRE SILVER;
C1, C4, C7, C26	-	4	C0402C105K8PAC	KEMET	1UF	CAPACITOR; SMT (0402); CERAMIC CHIP; 1UF; 10V; TOL=10%; TG=-55 DEGC TO +85 DEGC; TC=X5R
C2, C6, C12-C15, C21, C22, C24, C25, C28-C38	-	21	GRM155R71E104KE14	MURATA	0.1UF	CAPACITOR; SMT (0402); CERAMIC CHIP; 0.1UF; 25V; TOL=10%; MODEL=GRM SERIES; TG=-55 DEGC TO +125 DEGC; TC=X7R
C3	-	1	LKM105B7474KV	PANASONIC	0.47UF	CAPACITOR; SMT (0402); CERAMIC CHIP; 0.47UF; 10V; TOL=10%; TG=-55 DEGC TO +125 DEGC; TC=X7R
C5	-	1	C0402C103K5RAC;GRM155R71H103KA88;C1005X7R1H103K050BE	KEMET;MURATA;TDK	0.01UF	CAPACITOR; SMT (0402); CERAMIC CHIP; 0.01UF; 50V; TOL=10%; TG=-55 DEGC TO +125 DEGC; TC=X7R
C9	-	1	GRM155R71A104JA01	MURATA	0.1UF	CAPACITOR; SMT (0402); CERAMIC CHIP; 0.1UF; 10V; TOL=5%; TG=-55 DEGC TO +125 DEGC; TC=X7R
C20, C23, C27	-	3	GRM155R61A475MEAA	MURATA	4.7UF	CAPACITOR; SMT (0402); CERAMIC CHIP; 4.7UF; 10V; TOL=20%; TG=-55 DEGC TO +85 DEGC; TC=X5R
C39, C40	-	2	C0402C0G500270JNP;GRM1555C1H270JA01	VENKEL LTD.;MURATA	27PF	CAPACITOR; SMT; 0402; CERAMIC; 27pF; 50V; 5%; C0G; -55degC to +125degC; 0 +/-30PPM/degC
D1	-	1	LTST-C190CKT	LITE-ON ELECTRONICS INC.	LTST-C190CKT	DIODE; LED; STANDARD; RED; SMT (0603); PIV=5.0V; IF=0.04A; -55 DEGC TO +85 DEGC
D2-D4, D8	-	4	B2X384-C5V6	NXP	5.6V	DIODE; ZNR; SMT (SOD-323); Vz=5.6V; Izm=0.000001A; -65 DEGC TO +150 DEGC
D5, D6	-	2	MBR0520	MICRO COMMERCIAL COMPONENTS	MBR0520	DIODE; SCH; SCHOTTKY RECTIFIER; SMT (SOD-123); PIV=20V; IF=0.5A; -55 DEGC TO +150 DEGC
D7	-	1	RB520G-30	GENERIC PART	RB520G-30	DIODE; SCH; SCHOTTKY BARRIER DIODE; SMT (SOD-723); PIV=30V; IF=0.1A
DGND, GND	-	2	5011	KEYSTONE	N/A	TEST POINT; PIN DIA=0.125IN; TOTAL LENGTH=0.445IN; BOARD HOLE=0.063IN; BLACK; PHOSPHOR BRONZE WIRE SILVER PLATE FINISH;
DS1, DS2	-	2	LTST-C190GKT	LITE-ON ELECTRONICS INC.	LTST-C190GKT	DIODE; LED; WATER CLEAR GREEN; SMT (0603); VF=2.1V; IF=0.03A; -55 DEGC TO +85 DEGC
J1	-	1	10118193-0001LF	FCI CONNECT	10118193-0001LF	CONNECTOR; FEMALE; SMT; MICRO USB B TYPE RECEPTACLE; RIGHT ANGLE; SPINS
J2	-	1	PBC02SAAN	SULLINS ELECTRONICS CORP.	PBC02SAAN	EVKIT PART-CONNECTOR; MALE; THROUGH HOLE; BREAKAWAY; STRAIGHT; 2PINS; -65 DEGC TO +125 DEGC
L1-L3	-	3	BLM18AG601SN1	MURATA	600	INDUCTOR; SMT (0603); FERRITE-BEAD; 600; TOL=+/-; 0.5A
MISC1	-	1	AK67421-1-R	ASSMANN	AK67421-1-R	CONNECTOR; MALE; USB; USB2.0 MICRO CONNECTION CABLE; USB B MICRO MALE TO USB A MALE; STRAIGHT; 5PINS-4PINS
R1	-	1	RC0402JR-070RL; CR0402-16W-000RJT	YAGEO PHYCOMP;VENKEL LTD.	0	RESISTOR; 0402; 0 OHM; 5%; JUMPER; 0.063W; THICK FILM
R2, R9	-	2	ERJ-2RKF27R0X;RC0402FR-0727RL	PANASONIC;YAGEO PHICOMP	27	RESISTOR; 0402; 27 OHM; 1%; 100PPM; 0.0625W; THICK FILM
R5	-	1	KRL1220E-M-R010-F	SUSUMU CO LTD.	0.01	RES; SMT (0805); 0.01; 1%; +/-50PPM/DEGC; 0.5W
R6, R14-R16, R34	-	5	CRCW04021K00FK; RC0402FR-071KL	VISHAY DALE;YAGEO PHICOMP	1K	RESISTOR; 0402; 1K; 1%; 100PPM; 0.0625W; THICK FILM
R8, R12, R13	-	3	CRCW0402150RFK; RC04021A1500FL	VISHAY DALE;YAGEO	150	RESISTOR; 0402; 150 OHM; 1%; 100PPM; 0.0625W; THICK FILM
R11	-	1	CR0402-16W-3650FT	VENKEL LTD.	365	RESISTOR; 0402; 365 OHM; 1%; 100PPM; 0.063W; THICK FILM
R20	-	1	CRCW040210K0JN	VISHAY DALE	10K	RESISTOR; 0402; 10K OHM; 5%; 200PPM; 0.063W; THICK FILM
R23, R26	-	2	RC0805JR-070RL	YAGEO PHYCOMP	0	RESISTOR; 0805; 0 OHM; 5%; JUMPER; 0.125W; THICK FILM
R33	-	1	CRCW040212K0FK	VISHAY DALE	12K	RESISTOR; 0402; 12K OHM; 1%; 100PPM; 0.0625W; THICK FILM
R35, R36, R38, R39	-	4	ERJ-2GE0R00X	PANASONIC	0	RESISTOR; 0402; 0 OHM; 0%; JUMPER; 0.10W; THICK FILM
R37	-	1	CRCW04021M00FK	VISHAY DALE	1M	RESISTOR; 0402; 1M; 1%; 100PPM; 0.0625W; THICK FILM
R40, R41	-	2	CRCW04024K70FK	VISHAY DALE	4.7K	RESISTOR; 0402; 4.7K OHM; 1%; 100PPM; 0.0625W; THICK FILM
R42, R43	-	2	ERJ-2RKF1001X	PANASONIC	1K	RESISTOR; 0402; 1K OHM; 1%; 100PPM; 0.10W; THICK FILM
R46, R47	-	2	CRCW0402470RFK	VISHAY DALE	470	RESISTOR; 0402; 470 OHM; 1%; 100PPM; 0.0625W; THICK FILM
RT1	-	1	NCP15XH103F03RC	MURATA	10K	THERMISTOR; SMT (0402); THICK FILM (NICKEL PLATED); 10K; TOL=+/-1%
S1	-	1	EVQ-Q2K03W	PANASONIC	EVQ-Q2K03W	SWITCH; SPST; SMT; 15V; 0.02A; LIGHT TOUCH SWITCH; RCOIL= OHM; RINSULATION= OHM; PANASONIC
T1	-	1	TGM-040P3RL	HALO ELECTRONICS INC	TGM-040P3RL	TRANSFORMER; SMT; 1:1:1.3:1.3; PCMCIA DC/DC CONVERTER ;
U1	-	1	MAX17301G+	MAXIM	MAX17301G+	EVKIT PART - IC; BC26; MAX17301G+; PKG. OUTLINE DRAWING: 21-0137; PKG. CODE: T1433+2C; PKG. LAND PATTERN: 90-0063
U2	-	1	FT2232HL	FUTURE TECHNOLOGY DEVICES INTL LTD.	FT2232HL	IC; MMRY; DUAL HIGH SPEED USB TO MULTIPURPOSE UART/FIFO; LQFP64
U3	-	1	MAX14937AWE+	MAXIM	MAX14937AWE+	IC; ISO; TWO CHANNEL; SKVRMS I2C ISOLATOR; WSOIC16
U4	-	1	MAX13253ATB+	MAXIM	MAX13253ATB+	IC; DRV; TA SPREAD-SPECTRUM; PUSH-PULL; TRANSFORMER DRIVER FOR ISOLATED POWER SUPPLIES; TDFN10-EP
U5, U6	-	2	MAX8511EXK33+	MAXIM	MAX8511EXK33	IC; VREG; ULTRA-LOW-NOISE, HIGH PSRR, LOW-DROPOUT, LINEAR REGULATOR; SC70-5; -40 DEGC TO +85 DEGC
Y1	-	1	7M-12.000MAAJ	TXC CORPORATION	12MHZ	CRYSTAL; SMT; 18PF; 12MHZ; +/-30PPM; +/-30PPM
PCB	-	1	MAX17301GSOLDERDOWN	MAXIM	PCB	PCB;MAX17301GSOLDERDOWN
C16-C18	DNP	0	GRM1555C1E102JA01D; C1005C0G1E102J050BA	MURATA;TDK	1000PF	CAPACITOR; SMT (0402); CERAMIC CHIP; 1000PF; 25V; TOL=5%; TG=-55 DEGC TO +125 DEGC; TC=C0G
F1	DNP	0	SFR-0405A	DEXERIALS	SFR-0405A	IC; PROT; SELF CONTROL PROTECTOR; SMT ;
J3	DNP	0	PBC04DAAN	SULLINS ELECTRONICS CORP.	PBC04DAAN	CONNECTOR; MALE; THROUGH HOLE; BREAKAWAY; STRAIGHT; 8PINS; -65 DEGC TO +125 DEGC
Q1	DNP	0	FCAB21490L	PANASONIC	FCAB21490L	TRAN; NCH; CSP10; PD-(0.54W); IGSS-(0.00010A); VGS-(+/-8V);
Q2	DNP	0	2N7002	NXP	2N7002	TRAN; N-CHANNEL TRENCH MOSFET; NCH; SOT-23; PD-(0.83W); I-(0.3A); V-(60V)
Q3	DNP	0	FDPIC4044	ON SEMICONDUCTOR	FDPIC4044	TRAN; COMMON DRAIN N-CHANNEL POWER/TRENCH MOSFET; NCH; POWERCLIP-33; PD-(2.7W); I-(27A); V-(30V)
Q5, Q6	DNP	0	NDS8410A	FAIRCHILD SEMICONDUCTOR	NDS8410	MOSFET, N-CHANNEL, SO-8, PD=2.5W, ID=+/-10A, VDSS=30V, VGS=20V, VSD=0.8V, RDS(ON)=0.0130hm, -55degC TO +150degC
R7, R24	DNP	0	RC0805JR-070RL	YAGEO PHYCOMP	0	RESISTOR; 0805; 0 OHM; 5%; JUMPER; 0.125W; THICK FILM
R3, R4, R50	DNP	0	N/A	N/A	OPEN	RESISTOR; 0402; OPEN; FORMFACTOR

NOTE: DNI--> DO NOT INSTALL(PACKOUT); DNP--> DO NOT PROCURE

MAX173xxG EV Kit BOM U1 Ordering Guide

EV KIT PART NUMBER	U1 ORDERING INFORMATION
MAX17301GEVKIT#	MAX17301G+
MAX17311GEVKIT#	MAX17311G+
MAX17302GEVKIT#	MAX17302G+
MAX17312GEVKIT#	MAX17312G+
MAX17303GEVKIT#	MAX17303G+
MAX17313GEVKIT#	MAX17313G+

MAX1730xX/MAX1730xG/
MAX1731xX/MAX1731xG
Evaluation Kits

Evaluates: MAX17301-MAX17303/
MAX17311-MAX17313

MAX173xxG EV Kit Schematic

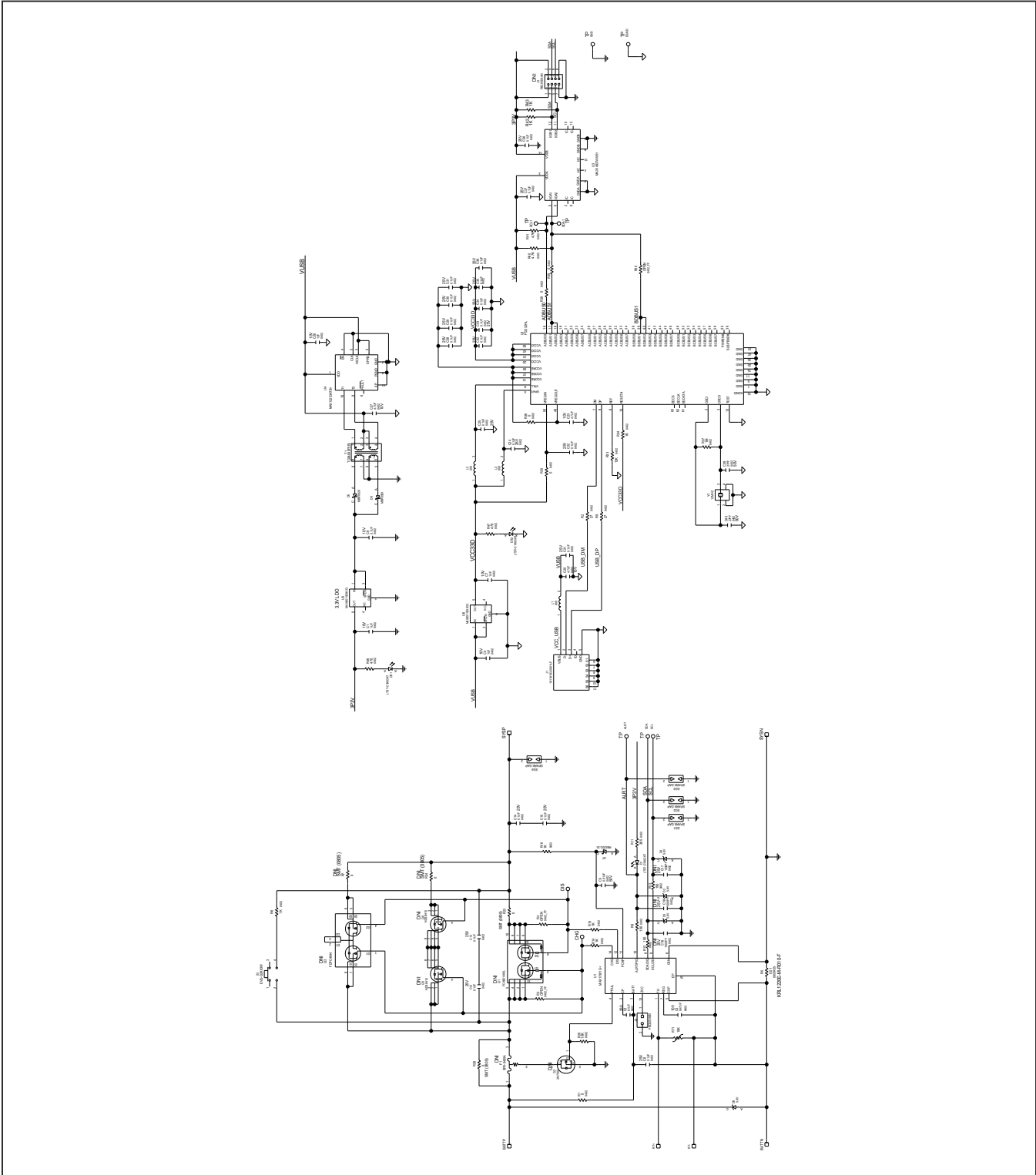

MAX1730xX/MAX1730xG/
MAX1731xX/MAX1731xG
Evaluation Kits

Evaluates: MAX17301-MAX17303/
MAX17311-MAX17313

MAX173xxG EV Kit PCB Layouts

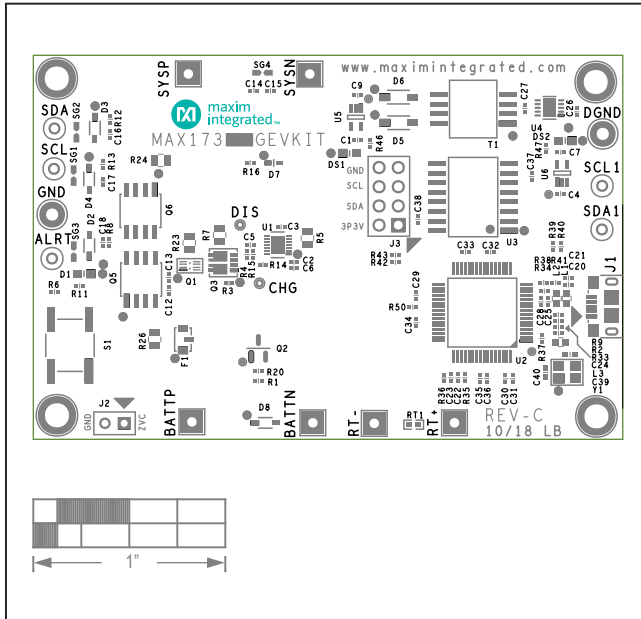

MAX173xxG EV Kit Component Placement Guide—Top Silkscreen

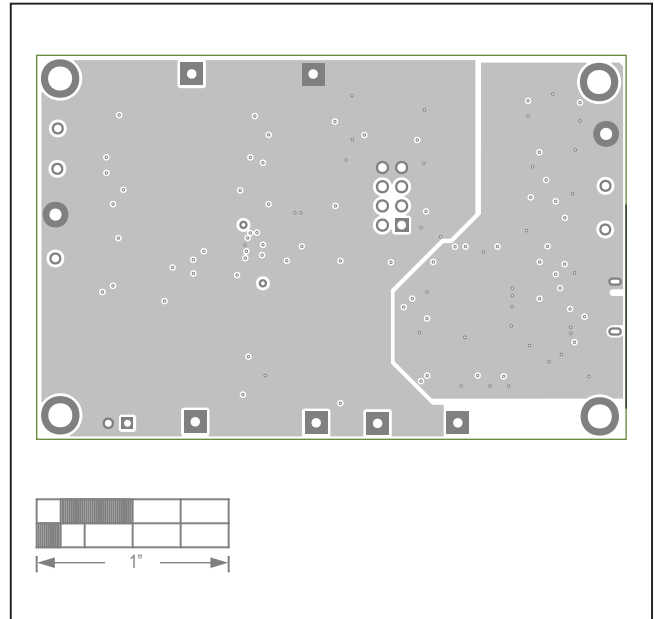

MAX173xxG EV Kit PCB Layout—Layer 2

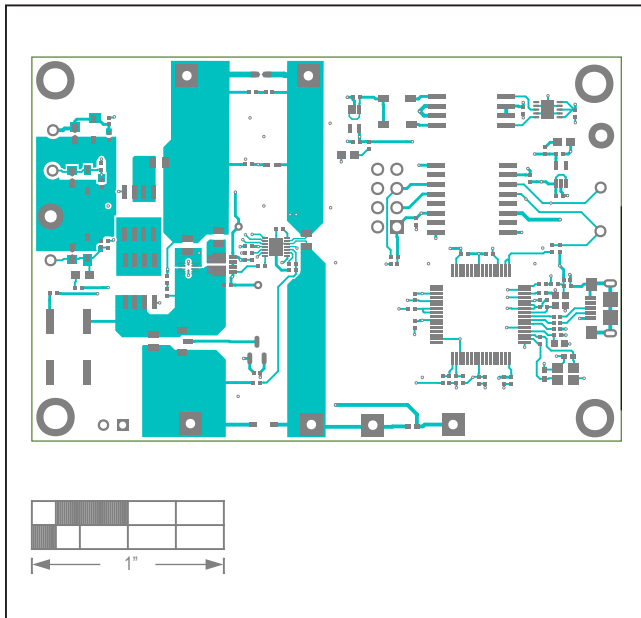

MAX173xxG EV Kit PCB Layout—Top Layer

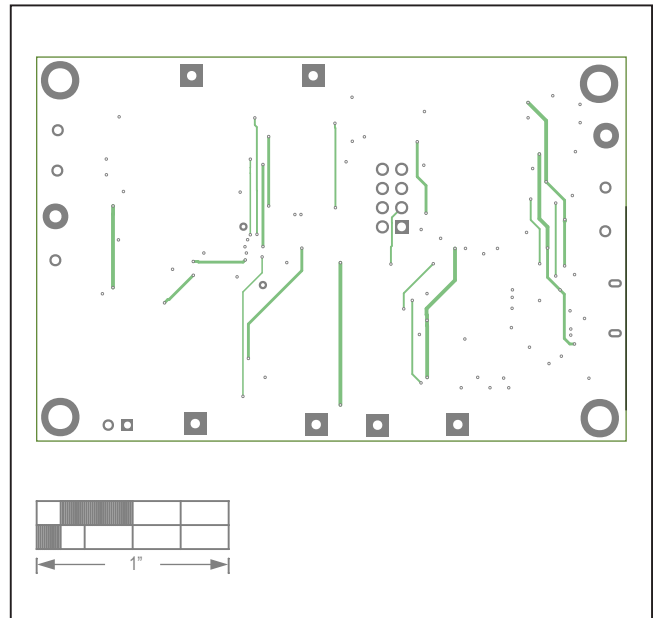

MAX173xxG EV Kit PCB Layout—Layer 3

MAX1730xX/MAX1730xG/
MAX1731xX/MAX1731xG
Evaluation Kits

Evaluates: MAX17301-MAX17303/
MAX17311-MAX17313

MAX173xxG EV Kit PCB Layouts (continued)

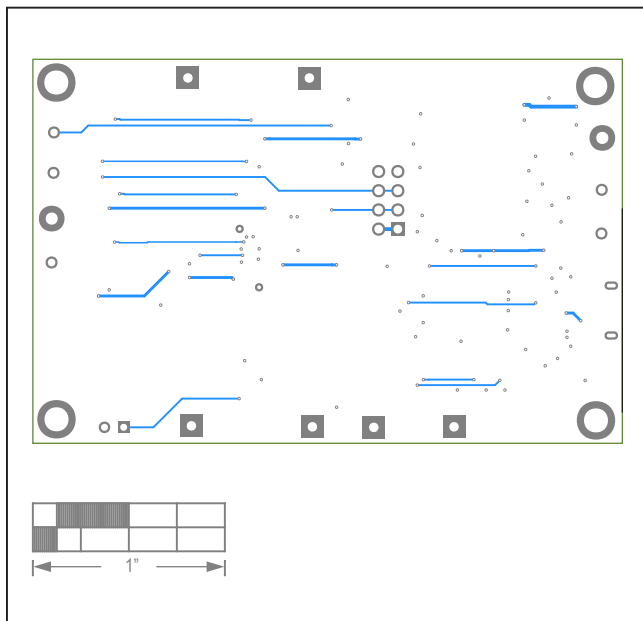

MAX173xxG EV Kit PCB Layout—Bottom Layer

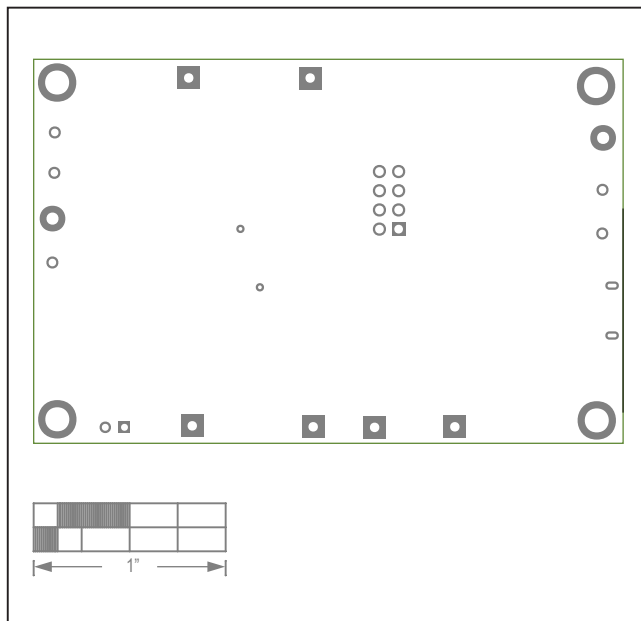

MAX173xxG EV Kit Component Placement Guide—Bottom Silkscreen

MAX1730xX/MAX1730xG/
MAX1731xX/MAX1731xG
Evaluation Kits

Evaluates: MAX17301-MAX17303/
MAX17311-MAX17313

MAX173xxX EV Kit Bill of Materials

REF_DES	DNI/DNP	QTY	MFG PART #	MANUFACTURER	VALUE	DESCRIPTION
ALRT, SCL, SCL1, SDA, SDA1	-	5	5002	KEYSTONE	N/A	TEST POINT; PIN DIA=0.1IN; TOTAL LENGTH=0.3IN; BOARD HOLE=0.04IN; WHITE; PHOSPHOR BRONZE WIRE SILVER;
C1, C4, C7, C26	-	4	C0402C105K8PAC	KEMET	1UF	CAPACITOR; SMT (0402); CERAMIC CHIP; 1UF; 10V; TOL=10%; TG=-55 DEGC TO +85 DEGC; TC=X5R
C2, C12, C15, C21, C22, C24, C25, C28-C38	-	20	GRM155R71E104KE14	MURATA	0.1UF	CAPACITOR; SMT (0402); CERAMIC CHIP; 0.1UF; 25V; TOL=10%; MODEL=GRM SERIES; TG=-55 DEGC TO +125 DEGC; TC=X7R
C3	-	1	GRM155R61A474KE15	MURATA	0.47UF	CAPACITOR; SMT (0402); CERAMIC CHIP; 0.47UF; 10V; TOL=10%; TG=-55 DEGC TO +85 DEGC; TC=X5R
C5	-	1	C0402C103K5RAC;GRM155R71H103KAB8;C1005X7R1H103K050BA	KEMET;MURATA;TDK	0.01UF	CAPACITOR; SMT (0402); CERAMIC CHIP; 0.01UF; 50V; TOL=10%; TG=-55 DEGC TO +125 DEGC; TC=X7R
C6, C9	-	2	GRM155R71A104JA01	MURATA	0.1UF	CAPACITOR; SMT (0402); CERAMIC CHIP; 0.1UF; 10V; TOL=5%; TG=-55 DEGC TO +125 DEGC; TC=X7R
C16-C18	-	3	GRM1555C1E102JA01D; C1005COG1E102J050BA	MURATA;TDK	1000PF	CAPACITOR; SMT (0402); CERAMIC CHIP; 1000PF; 25V; TOL=5%; TG=-55 DEGC TO +125 DEGC; TC=COG
C20, C23, C27	-	3	GRM155R61A475MEAA	MURATA	4.7UF	CAPACITOR; SMT (0402); CERAMIC CHIP; 4.7UF; 10V; TOL=20%; TG=-55 DEGC TO +85 DEGC; TC=X5R
C39, C40	-	2	C0402C0500270JNP; GRM1555C1H270JA01	VENKEL LTD.;MURATA	27PF	CAPACITOR; SMT; 0402; CERAMIC; 27pF; 50V; 5%; COG; -55degC to + 125degC; 0 +/-30PPM/degC
D1	-	1	LTST-C190CKT	LITE-ON ELECTRONICS INC.	LTST-C190CKT	DIODE; LED; STANDARD; RED; SMT (0603); PIV=5.0V; IF=0.04A; -55 DEGC TO +85 DEGC
D2-D4, D8	-	4	BZX384-C5V6	NXP	5.6V	DIODE; ZNR; SMT (SOD-323); Vz=5.6V; Irm=0.000001A; -65 DEGC TO +150 DEGC
D5, D6	-	2	MBR0520	MICRO COMMERCIAL COMPONENTS	MBR0520	DIODE; SCH; SCHOTTKY RECTIFIER; SMT (SOD-123); PIV=20V; IF=0.5A; -55 DEGC TO +150 DEGC
D7	-	1	R8520G-30	GENERIC PART	R8520G-30	DIODE; SCH; SCHOTTKY BARRIER DIODE; SMT (SOD-723); PIV=30V; IF=0.1A
DGND, GND	-	2	5011	KEYSTONE	N/A	TEST POINT; PIN DIA=0.125IN; TOTAL LENGTH=0.445IN; BOARD HOLE=0.063IN; BLACK; PHOSPHOR BRONZE WIRE SILVER PLATE FINISH;
DS1, DS2	-	2	LTST-C190GKT	LITE-ON ELECTRONICS INC.	LTST-C190GKT	DIODE; LED; WATER CLEAR GREEN; SMT (0603); Vf=2.1V; If=0.03A; -55 DEGC TO +85 DEGC
J1	-	1	10118193-0001LF	FCI CONNECT	10118193-0001LF	CONNECTOR; FEMALE; SMT; MICRO USB B TYPE RECEPTACLE; RIGHT ANGLE; SPINS
J2	-	1	PBC025AAN	SULLINS ELECTRONICS CORP.	PBC025AAN	EVKIT PART-CONNECTOR; MALE; THROUGH HOLE; BREAKAWAY; STRAIGHT; 2PINS; -65 DEGC TO +125 DEGC;
L1-L3	-	3	BLM18AG6015N1	MURATA	600	INDUCTOR; SMT (0603); FERRITE-BEAD; 600; TOL=+/-; 0.5A
MISC1	-	1	AK67421-1-R	ASSMANN	AK67421-1-R	CONNECTOR; MALE; USB; USB2.0 MICRO CONNECTION CABLE; USB B MICRO MALE TO USB A MALE; STRAIGHT; 5PINS-4PINS
R1	-	1	RC0402JR-070RL; RC0402-16W-000RJT	YAGEO PHYCOMP;VENKEL LTD.	0	RESISTOR; 0402; 0 OHM; 5%; JUMPER; 0.063W; THICK FILM
R2, R9	-	2	ERJ-2RKf27R0X;RC0402FR-0727RL	PANASONIC;YAGEO PHICOMP	27	RESISTOR; 0402; 27 OHM; 1%; 100PPM; 0.0625W; THICK FILM
R5	-	1	KRL1220E-M-R010-F	SUSUMU CO LTD.	0.01	RES; SMT (0805); 0.01; 1%; +/-50PPM/DEGC; 0.5W
R6, R14-R16, R34	-	5	CRCW04021K00FK; RC0402FR-071KL	VISHAY DALE;YAGEO PHICOMP	1K	RESISTOR; 0402; 1K; 1%; 100PPM; 0.0625W; THICK FILM
R8, R12, R13	-	3	CRCW0402150RfK; 9C04021A1500FL	VISHAY DALE;YAGEO	150	RESISTOR; 0402; 150 OHM; 1%; 100PPM; 0.0625W; THICK FILM
R11	-	1	CR0402-16W-3650FT	VENKEL LTD.	365	RESISTOR; 0402; 365 OHM; 1%; 100PPM; 0.063W; THICK FILM
R20	-	1	CRCW040210K0JN	VISHAY DALE	10K	RESISTOR; 0402; 10K OHM; 5%; 200PPM; 0.063W; THICK FILM
R23, R26	-	2	RC0805JR-070RL	YAGEO PHYCOMP	0	RESISTOR; 0805; 0 OHM; 5%; JUMPER; 0.125W; THICK FILM
R33	-	1	CRCW040212K0FK	VISHAY DALE	12K	RESISTOR; 0402; 12K OHM; 1%; 100PPM; 0.0625W; THICK FILM
R35, R36, R38, R39	-	4	ERJ-2GEOR00X	PANASONIC	0	RESISTOR; 0402; 0 OHM; 0%; JUMPER; 0.10W; THICK FILM
R37	-	1	CRCW04021M00FK	VISHAY DALE	1M	RESISTOR; 0402; 1M; 1%; 100PPM; 0.0625W; THICK FILM
R40, R41	-	2	CRCW04024K70FK	VISHAY DALE	4.7K	RESISTOR; 0402; 4.7K OHM; 1%; 100PPM; 0.0625W; THICK FILM
R42, R43	-	2	ERJ-2RKf1001X	PANASONIC	1K	RESISTOR; 0402; 1K OHM; 1%; 100PPM; 0.10W; THICK FILM
R46, R47	-	2	CRCW0402470RfK	VISHAY DALE	470	RESISTOR; 0402; 470 OHM; 1%; 100PPM; 0.0625W; THICK FILM
RT1	-	1	NCP15XH103F03RC	MURATA	10K	THERMISTOR; SMT (0402); THICK FILM (NICKEL PLATED); 10K; TOL=+/-1%
S1	-	1	EVQ-Q2K03W	PANASONIC	EVQ-Q2K03W	SWITCH; SPST; SMT; 15V; 0.02A; LIGHT TOUCH SWITCH; RCOIL= OHM; RINSULATION= OHM; PANASONIC
T1	-	1	TGM-040P3RL	HALO ELECTRONICS INC	TGM-040P3RL	TRANSFORMER; SMT; 1:1.1:3.1:3; PCMCIA DC/DC CONVERTER ;
U1	-	1	MAX17301X+	MAXIM	MAX17301X+	EVKIT PART - IC; BC26; MAX17301X+; PACKAGE OUTLINE DRAWING: 21-100256; PACKAGE CODE: W151H2+1; 0.50MM PITCH
U2	-	1	FT2232HL	FUTURE TECHNOLOGY DEVICES INTL LTD.	FT2232HL	IC; MMRY; DUAL HIGH SPEED USB TO MULTIPURPOSE UART/FIFO; LQFP64
U3	-	1	MAX14937AWE+	MAXIM	MAX14937AWE+	IC; ISO; TWO CHANNEL; SKVRMS I2C ISOLATOR; WSOIC16
U4	-	1	MAX13253ATB+	MAXIM	MAX13253ATB+	IC; DRV; 1A SPREAD-SPECTRUM; PUSH-PULL; TRANSFORMER DRIVER FOR ISOLATED POWER SUPPLIES; TDFN10-EP
U5, U6	-	2	MAX8511EXK33+	MAXIM	MAX8511EXK33	IC; VREG; ULTRA-LOW-NOISE, HIGH P5RR, LOW-DROPOUT, LINEAR REGULATOR; SC70-5; -40 DEGC TO +85 DEGC
Y1	-	1	7M-12.000MAJ	TXC CORPORATION	12MHZ	CRYSTAL; SMT; 18PF; 12MHZ; +/-30PPM; +/-30PPM
PCB	-	1	MAX17301XSOLDERDOWN	MAXIM	PCB	PCB;MAX17301XSOLDERDOWN
F1	DNP	0	SFR-0405A	DEXERIALS	SFR-0405A	IC; PROT; SELF CONTROL PROTECTOR; SMT ;
J3	DNP	0	PBC04DAAN	SULLINS ELECTRONICS CORP.	PBC04DAAN	CONNECTOR; MALE; THROUGH HOLE; BREAKAWAY; STRAIGHT; 8PINS; -65 DEGC TO +125 DEGC
Q1	DNP	0	FCAB21490L	PANASONIC	FCAB21490L	TRAN; NCH; CSP10; PD-(0.54W); IGSS-(0.000010A); VGS(+/-8V);
Q2	DNP	0	2N7002	NXP	2N7002	TRAN; N-CHANNEL TRENCH MOSFET; NCH; SOT-23; PD-(0.83W); I-(0.3A); V-(60V)
Q3	DNP	0	FDPC4044	ON SEMICONDUCTOR	FDPC4044	TRAN; COMMON DRAIN N-CHANNEL POWER TRENCH MOSFET; NCH; POWERCLIP-33; PD-(2.7W); I-(27A); V-(30V)
Q5, Q6	DNP	0	NDS8410A	FAIRCHILD SEMICONDUCTOR	NDS8410	MOSFET, N-CHANNEL, SO-8, PD=2.5W, ID=+/-10A, VDS=30V, VGS=-20V, VSD=0.8V, RDS(ON)=0.0130hm, -55degC TO +150degC
R7, R24	DNP	0	RC0805JR-070RL	YAGEO PHYCOMP	0	RESISTOR; 0805; 0 OHM; 5%; JUMPER; 0.125W; THICK FILM
R3, R4, R50	DNP	0	N/A	N/A	OPEN	RESISTOR; 0402; OPEN; FORMFACTOR

NOTE: DNI--> DO NOT INSTALL(PACKOUT); DNP--> DO NOT PROCURE

MAX173xxXEV Kit BOM U1 Ordering Guide

EV KIT PART NUMBER	U1 ORDERING INFORMATION
MAX17301XEVKIT#	MAX17301X+
MAX17311XEVKIT#	MAX17311X+
MAX17302XEVKIT#	MAX17302X+
MAX17312XEVKIT#	MAX17312X+
MAX17303XEVKIT#	MAX17303X+
MAX17313XEVKIT#	MAX17313X+

MAX1730xX/MAX1730xG/
MAX1731xX/MAX1731xG
Evaluation Kits

Evaluates: MAX17301-MAX17303/
MAX17311-MAX17313

MAX173xxX EV Kit Schematic

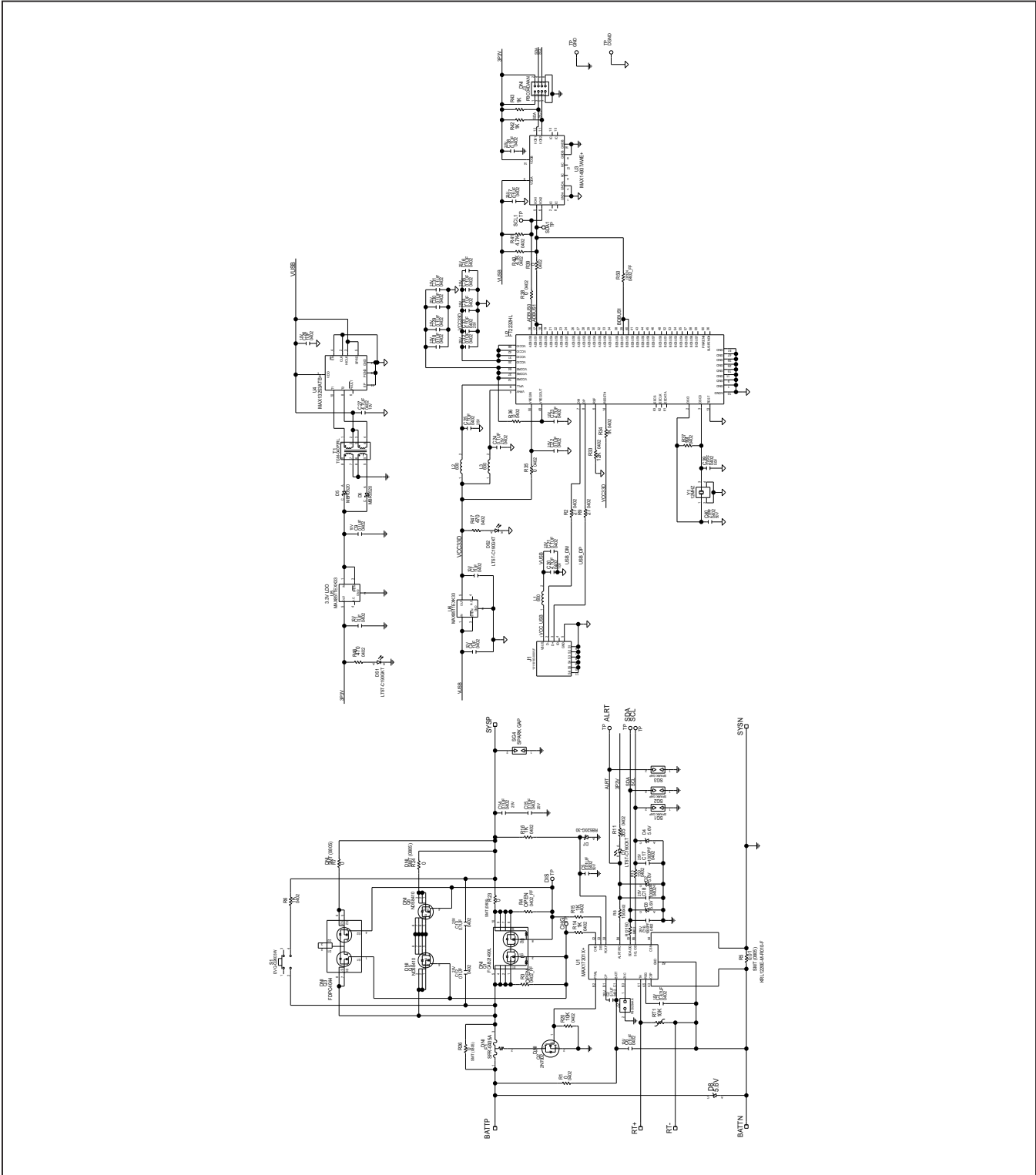

MAX1730xX/MAX1730xG/
MAX1731xX/MAX1731xG
Evaluation Kits

Evaluates: MAX17301-MAX17303/
MAX17311-MAX17313

MAX173xxX EV Kit PCB Layouts

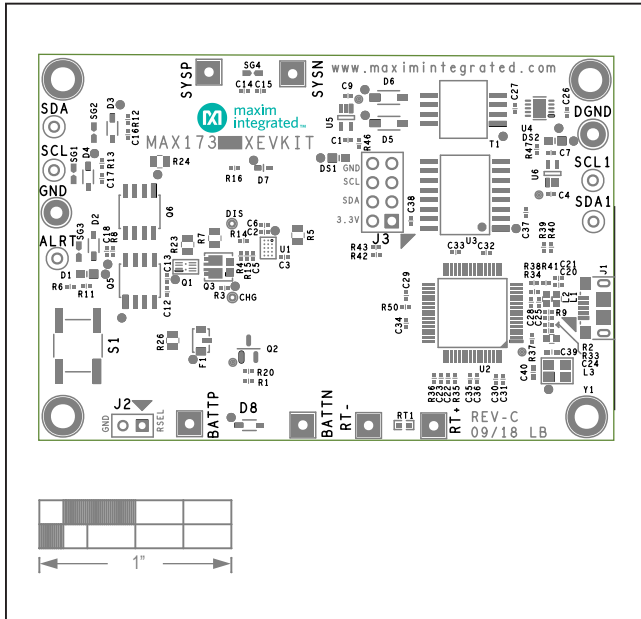

MAX173xxX EV Kit Component Placement Guide—Top Silkscreen

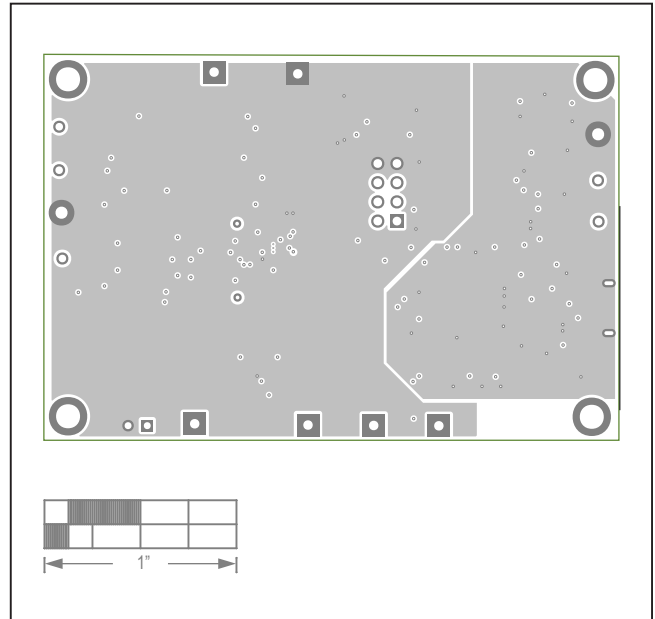

MAX173xxX EV Kit PCB Layout—Layer 2

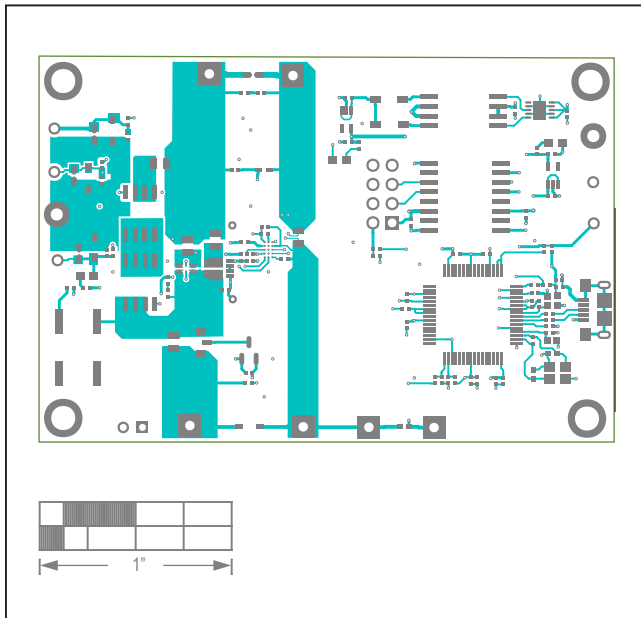

MAX173xxX EV Kit PCB Layout—Top Layer

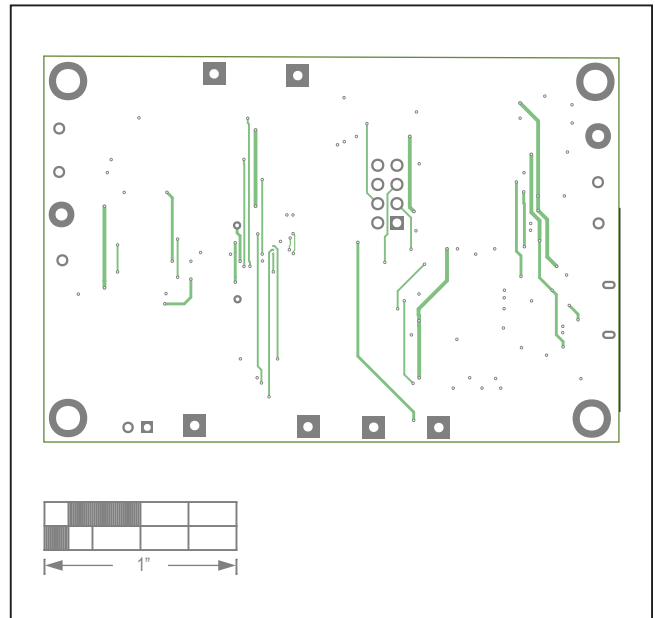

MAX173xxX EV Kit PCB Layout—Layer 3

MAX1730xX/MAX1730xG/
MAX1731xX/MAX1731xG
Evaluation Kits

Evaluates: MAX17301-MAX17303/
MAX17311-MAX17313

MAX173xxX EV Kit PCB Layouts (continued)

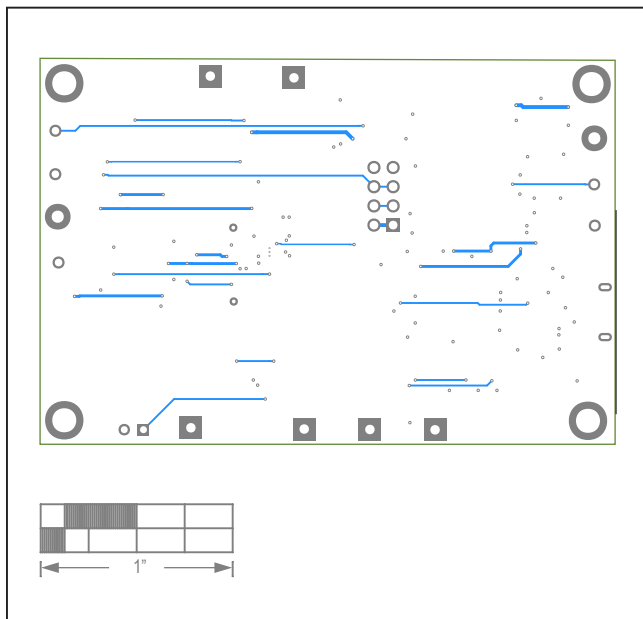

MAX173xxX EV Kit PCB Layout—Bottom Layer

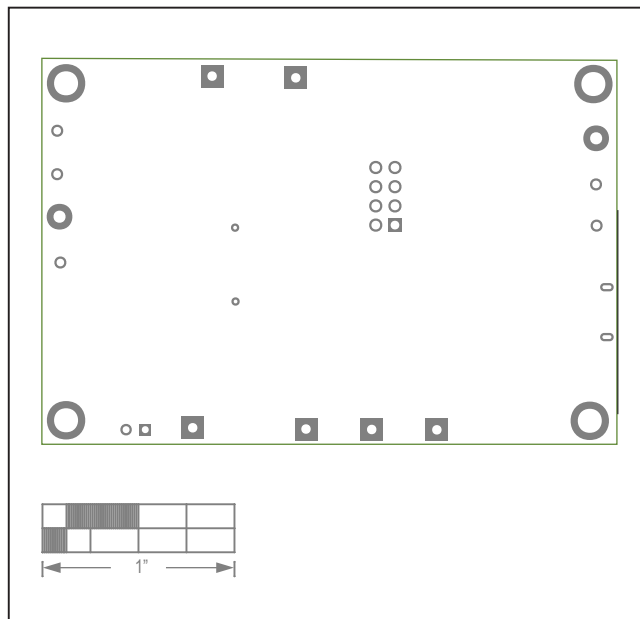

MAX173xxX EV Kit Component Placement Guide—Bottom Silkscreen

MAX1730xX/MAX1730xG/
MAX1731xX/MAX1731xG
Evaluation Kits

Evaluates: MAX17301-MAX17303/
MAX17311-MAX17313

Revision History

REVISION NUMBER	REVISION DATE	DESCRIPTION	PAGES CHANGED
0	3/19	Initial release	—
1	6/19	Updated <i>Ordering Information</i> table	20

For pricing, delivery, and ordering information, please visit Maxim Integrated's online storefront at <https://www.maximintegrated.com/en/storefront/storefront.html>.

Maxim Integrated cannot assume responsibility for use of any circuitry other than circuitry entirely embodied in a Maxim Integrated product. No circuit patent licenses are implied. Maxim Integrated reserves the right to change the circuitry and specifications without notice at any time.