

New!

KL series

Locking power rocker switches

Distinctive features

Unlocking actuator

Each KL rocker switch includes an unlocking actuator.

This actuator must be pressed to activate the protected function of the rocker. Moreover, two frames protect the unlocking actuator from untimely activation.

This intuitive and secured ergonomics is patented by APEM.

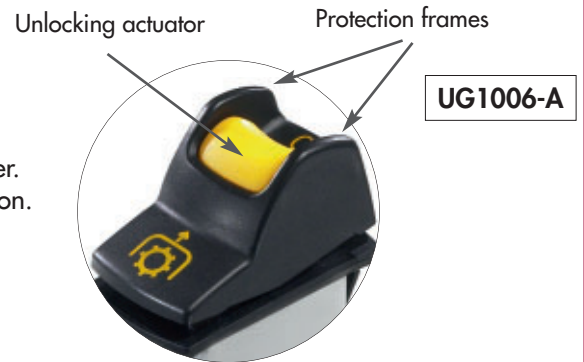

2 position versions (electrical functions 1, 5 and 6)

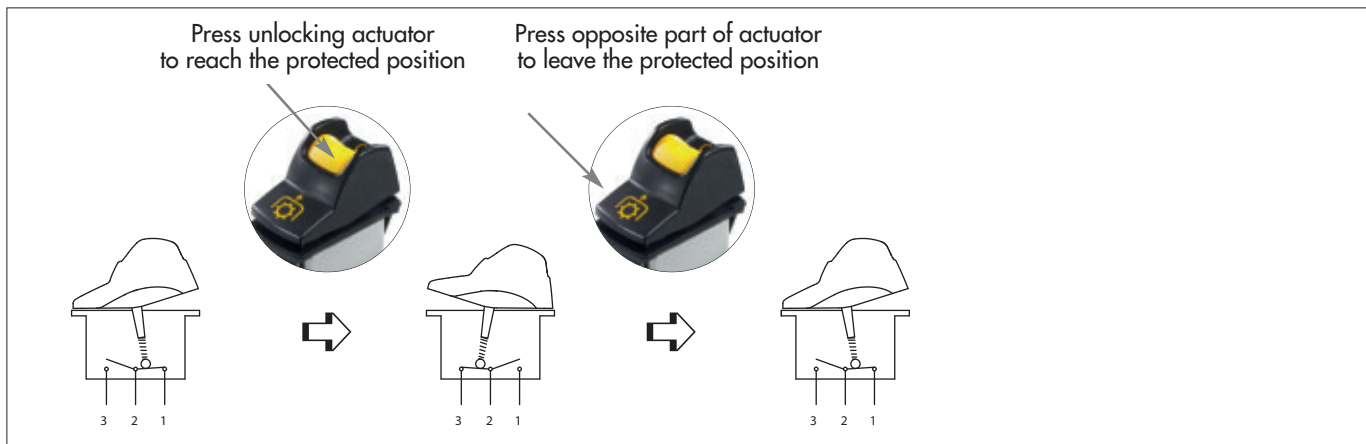

3 position versions (electrical functions 7, 8, 9 4, 4-1R)

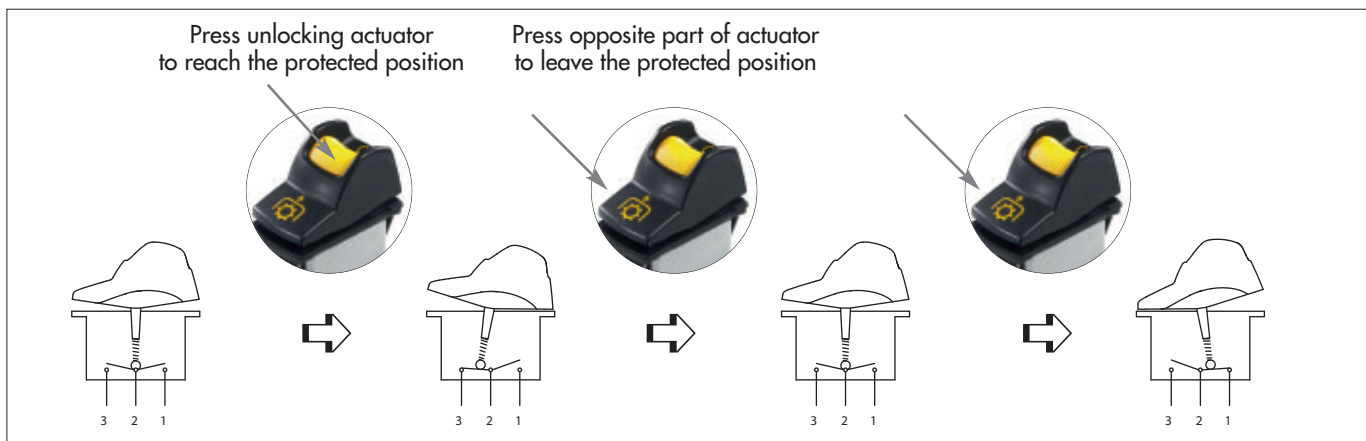

KL series

Locking power rocker switches

New!

Specifications



- One protected position
- Patented intuitive ergonomics
- Wide choice of colours
- Laser etched symbols
- Illuminated or non-illuminated
- Sealed to IP68

ELECTRICAL SPECIFICATIONS

- Current/voltage rating with resistive load :
 - Silver contacts (A) : 5A 24VDC, 100.000 cycles
10A 24VDC, 10.000 cycles (terminals 6.35 x 0.8 only)
 - Gold plated contacts (D) : 20mA 12V, 150.000 cycles
- Initial contact resistance : 10 mΩ max.
- Insulation resistance : 1.000 MΩ min. at 500VDC
- Dielectric strength : 2.000 Vrms 50 Hz min. between terminals
- Mechanical life : 150.000 cycles min.

MATERIALS

- Case : PA 6-6
- Actuator and unlocking actuator : ABS
- Bezel : PA 6-6
- Terminals : brass, silver plated
- Contacts : silver (A)
or silver, gold plated (D)
- Contact roller : brass, nickel plated

ENVIRONMENTAL SPECIFICATIONS

- Degree of protection of sealed versions : frontal sealing to IP68 according to IEC 60529 (submersion under 1 meter of water for more than 30 minutes)
- Salt spray resistance : 96 hours according to IEC 512-6, test 11f
- Operating temperature : -40°C to +85°C

SEALING

Sealing is optional.
To order a sealed product, complete the appropriate box of ordering format on the following pages.

DIMENSIONS

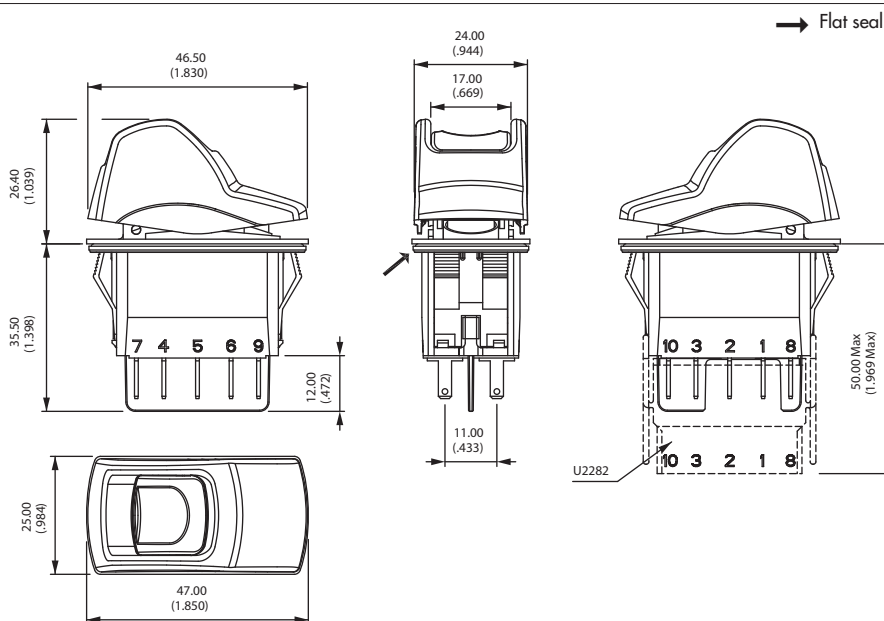

Packaging unit : 40 pieces

Dimensions : First dimensions are in mm while inches are shown as bracketed numbers.

New!

KL series

Locking power rocker switches

Selection guide

• To order a complete product, fill in all the boxes of the following order guide.

CASE + LEDS

| | | | | | | | |
|---|--|---|------------------------------|---|-----------------------------|-------------|---------------|
| KL | | | | | | Side B | |
| SERIES | Electrical functions | | | Contacts | Sealing | LEDS | Wiring |
| Poles | <p>1 ON - OFF</p> <p>4 ON ON ON</p> <p>4-1R ON ON MOM</p> <p>5 MOM - ON</p> <p>6 ON - ON</p> <p>7 MOM OFF MOM</p> <p>8 ON OFF MOM</p> <p>9 ON OFF ON</p> <p>Function 1 only for 6-terminal versions.</p> <p>Functions 5 and 6 cannot be combined with "H" wiring.</p> | <p>A Silver</p> <p>D Gold plated</p> | <p>X No</p> <p>K Yes</p> | <p>X None</p> <p>A LED 6V red</p> <p>B LED 6V green</p> <p>C LED 6V yellow</p> <p>M LED 6V blue</p> <p>R LED 6V white</p> <p>D LED 12V red</p> <p>E LED 12V green</p> <p>F LED 12V yellow</p> <p>N LED 12V blue</p> <p>S LED 12V white</p> <p>J LED 24V red</p> <p>K LED 24V green</p> <p>L LED 24V yellow</p> <p>P LED 24V blue</p> <p>T LED 24V white</p> | <p>See following pages.</p> | | |
| <p>3 Single pole</p> <p>4 Double pole</p> | Terminals | | Terminals (continued) | | | | |
| | <p>Screw</p> <p>0 6 terminals with barrier</p> <p>Solder lug/quick-connect</p> <p>2 6 terminals with barrier</p> <p>4 6 terminals w/o barrier</p> <p>A 10 term. with barrier</p> <p>B 10 term. w/o barrier</p> <p>C 10 terminals for use with connector U2292</p> <p>Quick-connect 6,35x0,8</p> <p>3 6 terminals with barrier</p> | <p>Quick-connect 6,35x0,8</p> <p>5 6 terminals w/o barrier</p> <p>D 10 term. with barrier</p> <p>E 10 term. w/o barrier</p> <p>F 10 term. for use with connector U2292</p> <p>Quick-connect 2,8x0,8</p> <p>G 10 term. with barrier</p> <p>H 10 term. w/o barrier</p> <p>J 10 terminals for use with connector U2282</p> | | | | | |

ACTUATOR

| | | |
|--|--|--|
| | | |
| Type | Rocker colour | Unlocking actuator colour |
| <p>1 For non-illum. application</p> <p>2 For illuminated application</p> | <p>1 Blue</p> <p>1/4 Dark blue</p> <p>2 Black</p> <p>3 Green</p> <p>4 Grey</p> <p>5 Yellow</p> <p>6 Red</p> <p>7 Ivory</p> <p>9 Orange</p> | <p>1 Blue</p> <p>1/4 Dark blue</p> <p>2 Black</p> <p>3 Green</p> <p>4 Grey</p> <p>5 Yellow</p> <p>6 Red</p> <p>7 Ivory</p> <p>9 Orange</p> |

ACTUATOR MARKING

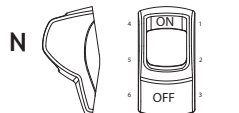
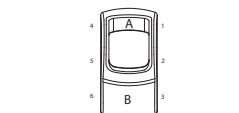
| | | | |
|---|--|--------|--|
| | Area A | Area B | |
| Orientation | Symbols | | Marking colour |
|  |  | | <p>Illuminated models</p> <p>Blank White</p> <p>Non-illuminated</p> <p>1 Blue</p> <p>2 Black</p> <p>3 Green</p> <p>4 Grey</p> <p>5 Yellow</p> <p>6 Red</p> <p>7 White</p> <p>9 Orange</p> |
| Symbols & Accessories : see end of section D. | | | |



NOTICE : please note that not all combinations of above numbers are available. Refer to the following pages for further information.

KL series

Locking power rocker switches

New!

Case

MODEL
STRUCTURE

CASE + LEDS

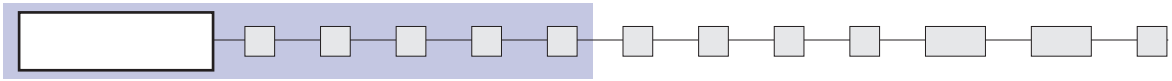

| | 2-3 | 5-6 | 1-2 | 4-5 |
|---------------------|-----|-----|-----|-----|
| Single pole KL31 | ON | - | OFF | |
| Double pole KL41 | ON | ON | ON | |
| | ON | ON | MOM | |
| KL35 | MOM | - | ON | |
| KL36 | ON | - | ON | |
| KL37 | MOM | OFF | MOM | |
| KL38 | ON | OFF | MOM | |
| KL39 | ON | OFF | ON | |

* Function 4 : single pole in double pole case

Bottom view

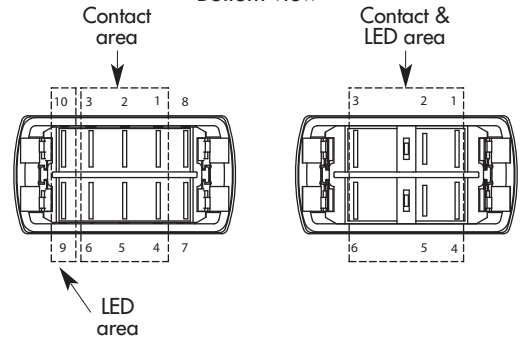

10 terminal version

6 terminal version

ELECTRICAL FUNCTIONS AND CONNECTIONS

In the tables below, terminal connections as viewed from bottom of switch. Only the contact area is represented. For single pole models, only terminals 1, 2 and 3 are to be considered (not 6, 5, 4).

x = w/o terminal
o = with terminal
▲ = momentary

| | 2 positions | |
|---------------------------|-------------------------------------|--|
| | | |
| | Press unlocking actuator to unlock. | |
| Function 1 * KL31-KL41 | | |
| Function 5 KL35 - KL45 | | |
| Function 6 KL36-KL46 | | |

*** Function 1**

- Only available for 6 terminal versions.
- Illuminated versions only available with "A" wiring.

| | 3 positions | | |
|--------------------------|-------------|--|--|
| | | | |
| Function 7 KL37-KL47 | | | |
| Function 8 KL38-KL48 | | | |
| Function 9 KL39-KL49 | | | |
| Function 4 KL44 | | | |
| Function 4-1R KL44-1R | | | |

New!

KL series

Locking power rocker switches

Case

TERMINALS

CASE + LEDS

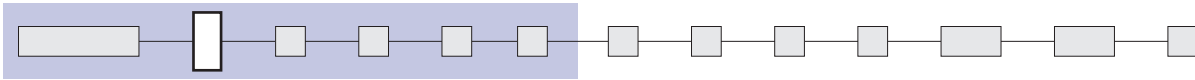

Screw

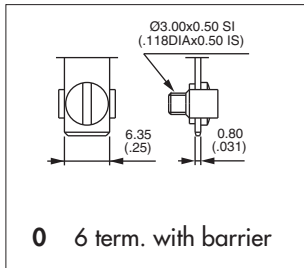

Solder lug / quick-connect

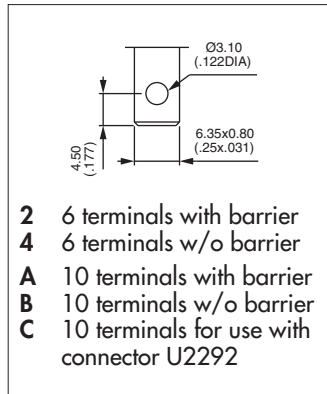

Normalized quick-connect 6,35x0,8

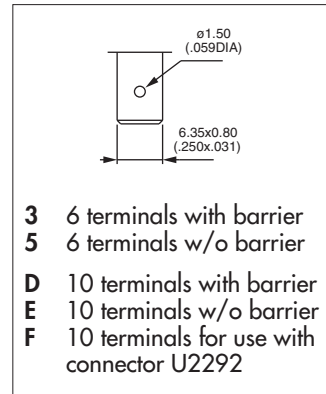

Normalized quick-connect 2,8x0,8

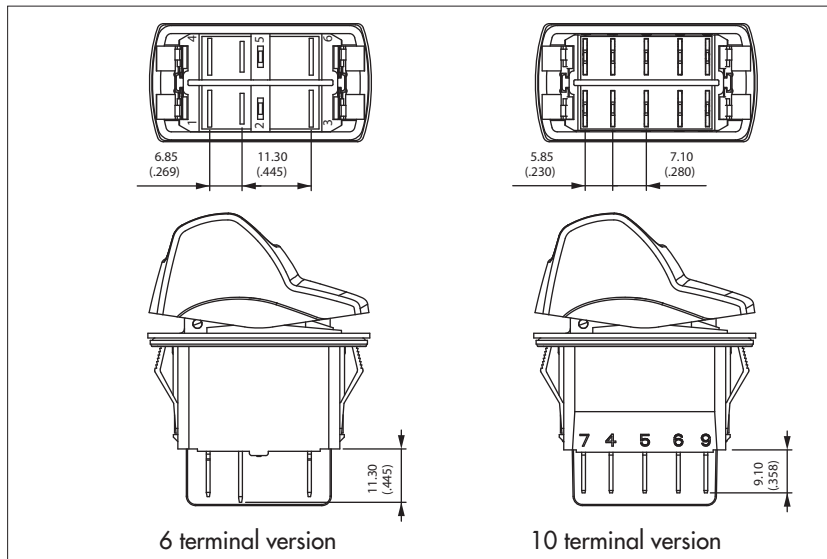
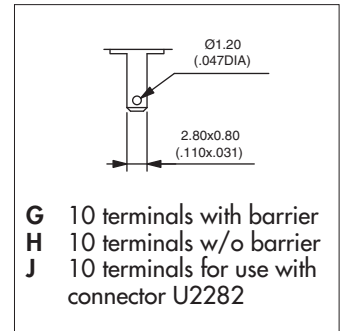

Terminals are marked on the case.

The drawings show the maximum possible number of terminals.

CONTACT MATERIALS

CASE + LEDS

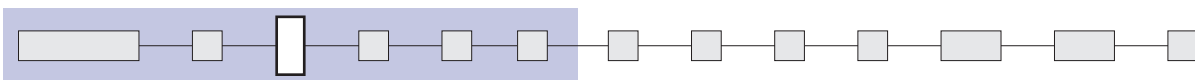

- A** Silver
- D** Silver, gold plated

KL series

Locking power rocker switches

Case - LEDs

New!

SEALING

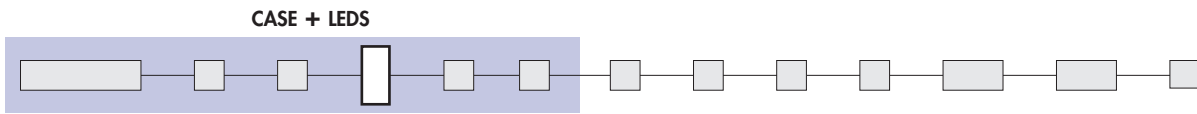

X No sealing

K IP68 (switch assembled on panel)

Ultrasonic welding of frame to case is standard on all versions.
The ultrasonic welding and the optional panel seal prevent water and dust from introducing into the switch housing.

*The product shall be installed professionally.
Test conditions available on request.*

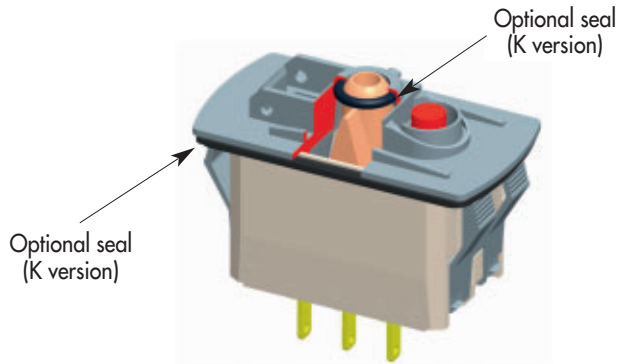

LEDS

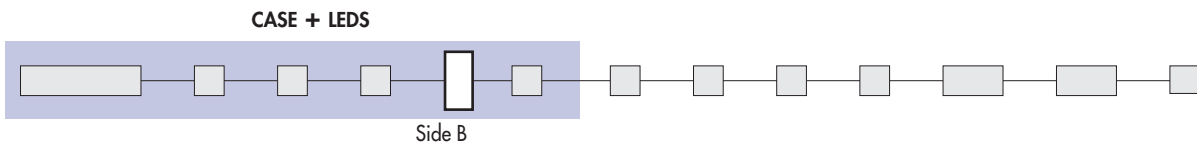

Complete enlarged box with one of the codes listed below.

X Without LED

| | Red | Green | Yellow | Blue | White |
|-------|----------|----------|----------|----------|----------|
| 6VDC | A | B | C | M | R |
| 12VDC | D | E | F | N | S |
| 24VDC | J | K | L | P | T |

LED consumption : 20mA @ nominal voltage (25°C)

Other illumination solutions : on request.

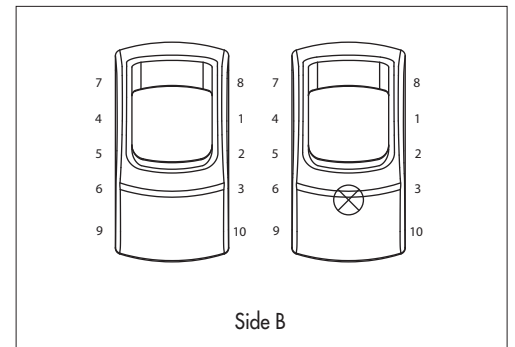

New!

KL series

Locking power rocker switches

Case - LED

WIRING

The LED wiring diagram is shown on the case.

CASE + LED

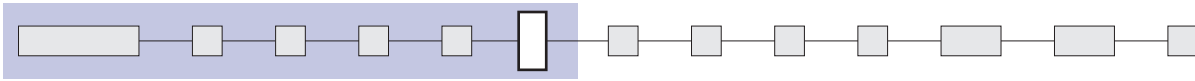

• For 6 terminal versions

LED connected to the load

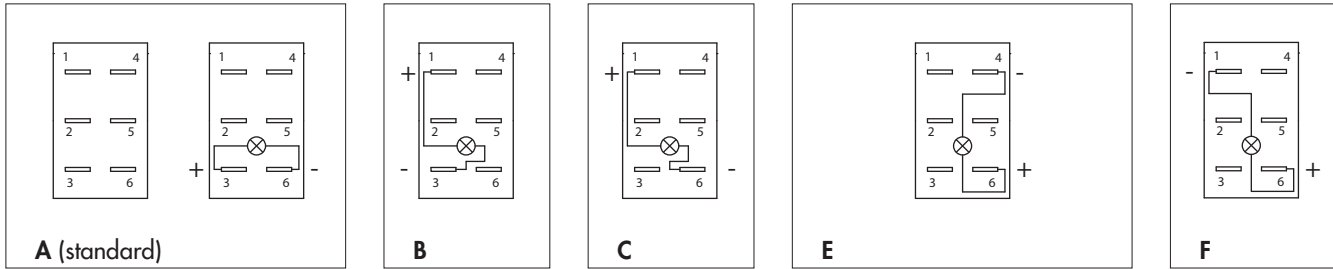

Note : If not available, terminals are added to connect the LED.

• For 10 terminal versions

Independent LED or integrated functions

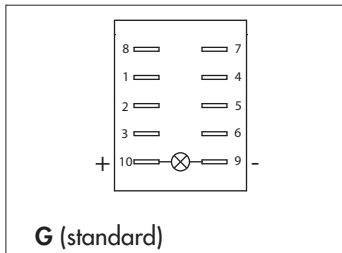

To have independent LED.

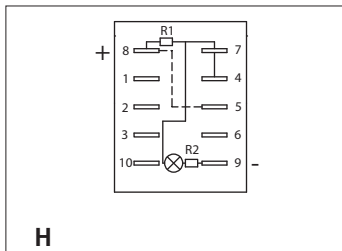

To obtain 2 symbol illumination levels (night illumination when OFF and higher illumination when ON).
Dotted line = external wiring, continuous line = internal wiring

Available in Single Pole only, with H and J quick-connect terminals.

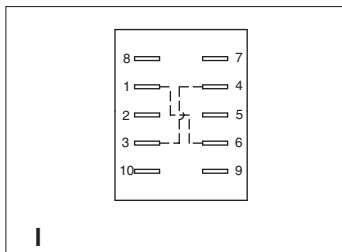

To have a polarity inversion (typical application : fan motor).
Dotted line = external wiring

Power supply between 2 and 5 - Load between 1 and 4 or 3 and 6.
Available with H and J quick-connect terminals.

Please contact us for other wiring solutions.

KL series

Locking power rocker switches

Actuator - Marking

New!

ACTUATOR TYPE

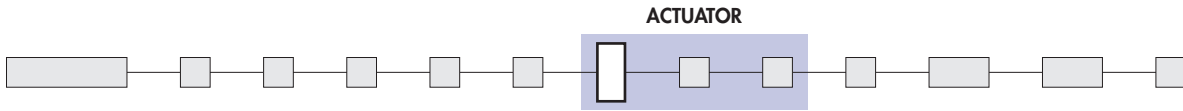

- 1 For non-illuminated application
- 2 For illuminated application

ROCKER COLOUR

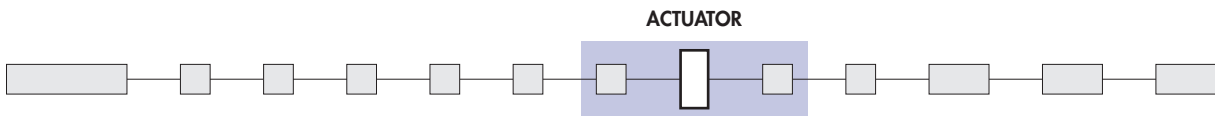

| Code | Colour |
|------|-----------|
| 1 | Blue |
| 1/4 | Dark blue |
| 2 | Black |

| Code | Colour |
|------|--------|
| 3 | Green |
| 4 | Grey |
| 5 | Yellow |

| Code | Colour |
|------|--------|
| 6 | Red |
| 7 | Ivory |
| 9 | Orange |

Note : colour 7 not available on illuminated versions

UNLOCKING ACTUATOR COLOUR

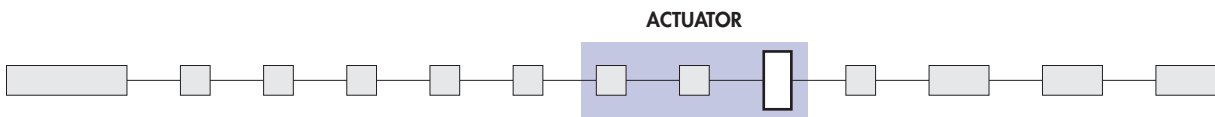

| Code | Colour |
|------|-----------|
| 1 | Blue |
| 1/4 | Dark blue |
| 2 | Black |

| Code | Colour |
|------|--------|
| 3 | Green |
| 4 | Grey |
| 5 | Yellow |

| Code | Colour |
|------|--------|
| 6 | Red |
| 7 | Ivory |
| 9 | Orange |

MARKING ORIENTATION

If no marking required, leave box blank.

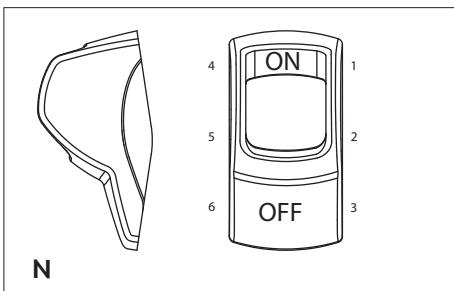
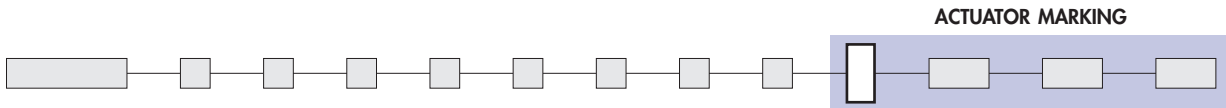

Other orientations : on request

New!

KL series

Locking power rocker switches

Marking - Mounting

SYMBOLS

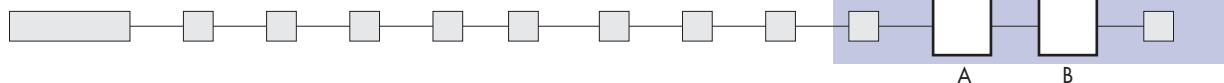

XX No symbol

Available symbols : see end of section D.

Laser etching resistance

- Water and petrol resistant according to EN61058-1
- Tear resistant (cross-cut test) according to NF ISO 2409 : class 0
- UV resistant according to ISO 4892-2

Marking area - The symbol will be included in the hatched area.

ACTUATOR MARKING

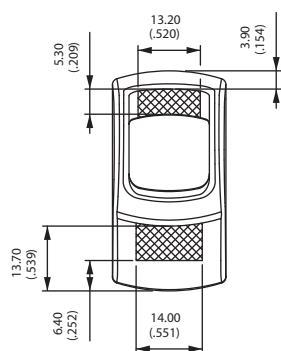
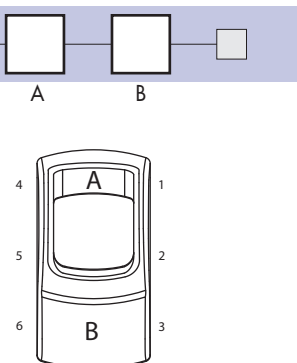

For illuminated versions

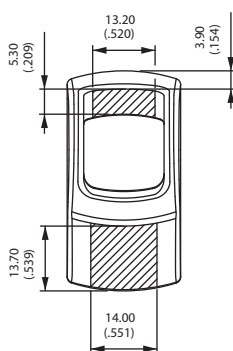

For non-illuminated versions

MARKING COLOUR

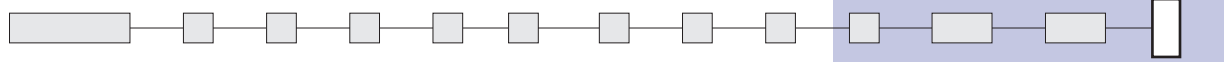

ACTUATOR MARKING

Illuminated models (laser etching)

Blank White

Non-illuminated models (pad printing)

1 : Blue - **2** : Black - **3** : Green - **4** : Grey - **5** : Yellow - **6** : Red - **7** : White - **9** : Orange

SWITCH PANEL CUT-OUT

Panel thickness : 0,8 mm to 4,6 mm

Recommended panel thickness :
between 2 mm and 3,5 mm

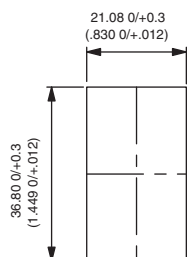

MATRIX MOUNTING

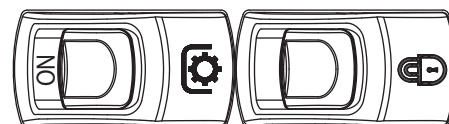
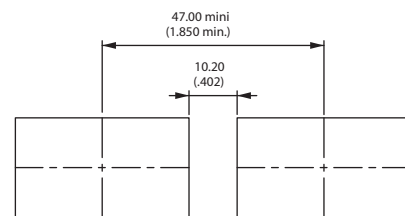
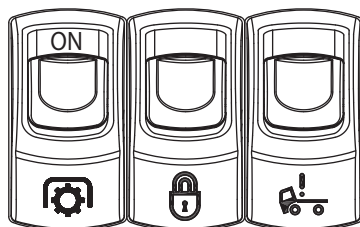
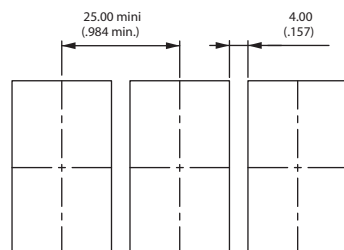

D

K range

Power rocker switches and indicators

Symbols

Most symbols meet the ISO 7000 standard "graphical symbols for use on equipments" (code given in bracket in the description). Contact us for symbols not featured in the following tables.

UG1006-A

Legend scale :

KR series : 1:1

KL, KG and KI series : depending on space available on the product (see "Symbols" section at the end of each series).

| CODE | SYMBOL | DESCRIPTION |
|------|--------|------------------------|
| XX | None | - |
| 01 | ON | - |
| 02 | OFF | - |
| 03 | ○ | - |
| 04 | I | - |
| 05 | II | - |
| 06 | STOP | - |
| 07 | A | Stop |
| 08 | M | Motion |
| 09 | ▲ | Up motion |
| 10 | ▼ | Down motion |
| 11 | ☀ | Hot |
| 12 | ✱ | Cold |
| 13 | ▲ | Hazard warning (0085) |
| 14 | ☰ | Traveller lighting |
| 15 | ☽ | Driver lighting (1421) |

| CODE | SYMBOL | DESCRIPTION |
|------|--------|--------------------------------------|
| 16 | ☰ | Revolving light |
| 17 | ☰ | Rear ventilator |
| 18 | ☰ | Heating (0637) |
| 19 | ☰ | Door opening |
| 20 | ☰ | Windshield demister/defroster (0635) |
| 21 | ☰ | Windshield wiper (0086) |
| 22 | ☰ | Windshield washer (0088) |
| 23 | ☰ | Ventilator fan (0089) |
| 24 | ☰ | Side mirror defroster |
| 25 | ☰ | Restarting pump |
| 26 | ☰ | Front fog lights (0633) |
| 27 | ☰ | Rear fog lights (0634) |
| 28 | ☰ | Propulsion system trim |
| 29 | ☰ | Beacon (1141) |
| 30 | ☰ | Anchor |
| 31 | ☰ | Electric motor (0011) |

| CODE | SYMBOL | DESCRIPTION |
|------|--------|---------------------------------------|
| 32 | ☰ | Emergency first aid vehicle (2565) |
| 33 | ☰ | Load tipping (1557) |
| 34 | ☰ | Loading light (2457) |
| 35 | ☰ | Tractor, rear-ward (1667) |
| 36 | ☰ | Combine, direction of movement (1678) |
| 37 | ☰ | Use no forks (2406) |
| 38 | ☰ | Transmission (1166) |
| 39 | ☰ | Working spot light (1145) |
| 40 | ☰ | Engine (0640) |
| 41 | ☰ | Horn (0244) |
| 42 | ☰ | Lock (1656) |
| 43 | ☰ | Taxi sign light (2551) |
| 44 | ☰ | Working light (1204) |
| 45 | ☰ | Working light symmetric (1204) |
| 46 | ☰ | - |
| 47 | ASM | - |

K range

Power rocker switches and indicators





































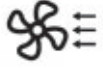

Symbols

Most symbols meet the ISO 7000 standard "graphical symbols for use on equipments" (code given in bracket in the description). Contact us for symbols not featured in the following tables.

Legend scale :

KR series : 1:1

KL, KG and KI series : depending on space available on the product (see "Symbols" section at the end of each series).

| CODE | SYMBOL | DESCRIPTION | CODE | SYMBOL | DESCRIPTION | CODE | SYMBOL | DESCRIPTION |
|------|---|---------------------------|------|---|--------------------------|------|---|--------------------------|
| 48 |  | All wheel drive | 64 |  | Indicator | 80 |  | Front windshield heating |
| 49 |  | Differential lock (1662) | 65 |  | Brake release | 81 | AUS | Aus |
| 50 |  | - | 66 |  | Baggage room left door | 82 |  | Radiator fan |
| 51 |  | - | 67 |  | Baggage room right door | 83 |  | Remove retarder |
| 52 |  | - | 68 |  | Power blinds | 84 |  | Restricted speed |
| 53 | N | - | 69 |  | Engine idle control | 85 |  | Preheater |
| 54 |  | Rear window wiper (0097) | 70 | CRUISE RES/SET | Cruise res/set | 86 |  | ABS detection |
| 55 |  | Rear window washer (0099) | 71 |  | Driver windows up/down | 87 |  | ECAS detection |
| 56 |  | Lower load (2223) | 72 |  | Middle door opening | 88 |  | Engine stop |
| 57 |  | Cab lock (1560) | 73 |  | Front door opening | 89 | CRUISE RES/CAN | Cruise res/cancel |
| 58 |  | Extraction | 74 |  | Lighting in baggage room | 90 |  | ECAS reset |
| 59 |  | Pumping in | 75 | CRUISE ON/OFF | Cruise on/off | 91 |  | Driver windows heating |
| 60 |  | Rear PTO (1572) | 76 | TV | TV | 92 | CRUISE SET+/-SET- | Cruise set |
| 61 |  | Front PTO | 77 |  | Pump | 93 |  | Air bag up/down |
| 62 |  | Rockshaft down | 78 | WC | Toilet | 94 |  | Read lighting |
| 63 |  | Rockshaft up | 79 |  | Toilet decontamination | 95 |  | Lighting main switch |

K range

Power rocker switches and indicators

















Symbols

















Most symbols meet the ISO 7000 standard "graphical symbols for use on equipments" (code given in bracket in the description). Contact us for symbols not featured in the following tables.





Legend scale :

KR series : 1:1

KL, KG and KI series : depending on space available on the product (see "Symbols" section at the end of each series).

| CODE | SYMBOL | DESCRIPTION |
|------|---|------------------------------|
| 96 |  | Heating using water |
| 97 |  | Low beam |
| 98 |  | Position lights |
| 99 |  | Diesel acceleration |
| A1 |  | Manual mode |
| A2 |  | Clockwise cabin rotation |
| A3 |  | Anticlockwise cabin rotation |
| A4 |  | - |
| A5 |  | - |
| A6 |  | Parking brake |
| A7 |  | - |
| A8 |  | - |
| A9 |  | - |
| AA |  | - |
| AB |  | - |
| AC |  | - |

| CODE | SYMBOL | DESCRIPTION |
|------|---|---|
| AD |  | - |
| AE |  | - |
| AF |  | - |
| AG |  | Battery charging condition (0247) |
| AH |  | Turn signals (0084) |
| AJ |  | High beam (0082) |
| AK |  | Differential lock, bogie (2600) |
| AL |  | Brushing with a rotating brush (0070) |
| AM |  | Differential lock, transfer case 4x4 (2475) |
| AN |  | Loader bucket, float (1441) |
| AP |  | Loader bucket (1437) |
| AQ |  | Rear window washer & wiper (0098) |
| AR |  | Header Header drive (1579) |
| AS |  | Excavator/backhoe boom side shift (2091) |
| AT |  | Chemical water treatment (1851) |
| AU |  | Grapple skidder, single funct° boom (1762) |

| CODE | SYMBOL | DESCRIPTION |
|------|---|-------------|
| AV |  | - |
| AW |  | - |
| AY |  | - |
| AZ |  | - |
| B1 | HIGH | - |
| B2 | LOW | - |
| B3 |  | - |

K range

Power rocker switches and indicators

Accessories for KR, KL and KI series

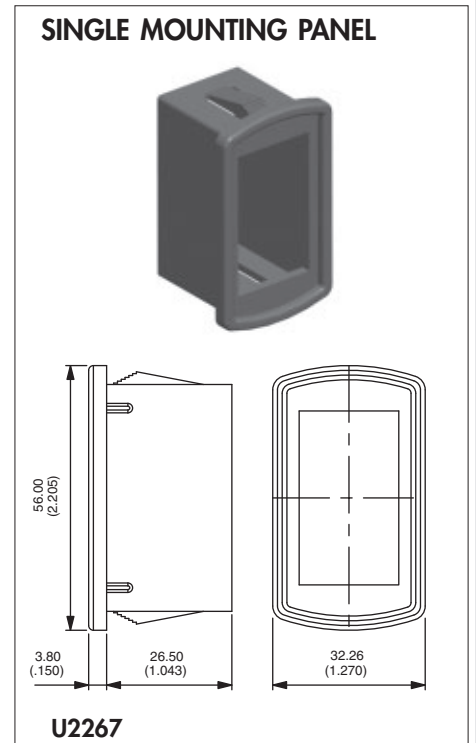
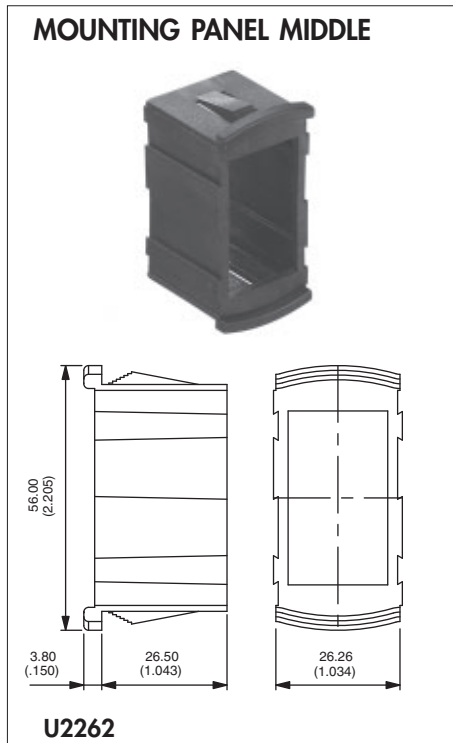
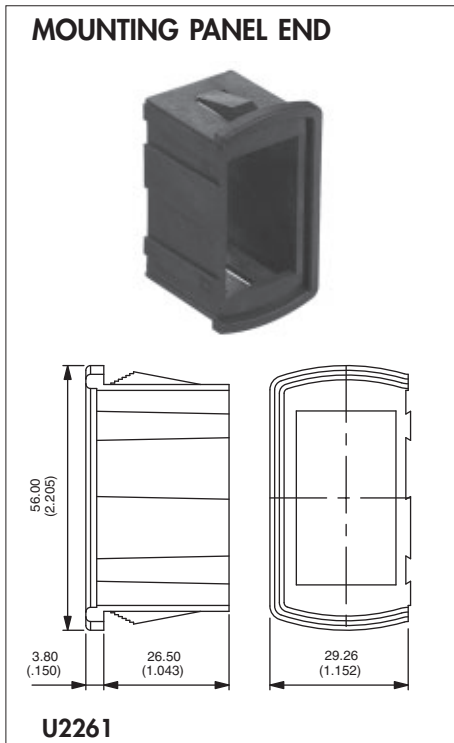

Recommended panel thickness : 1,10 mm - 1,80 mm - 2,60 mm - 3,40 mm - 4,20 mm - 5 mm - 5,80 mm

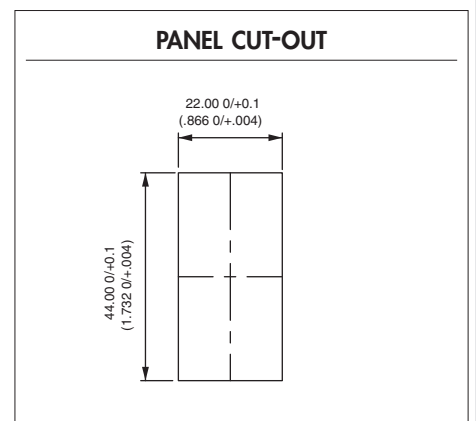
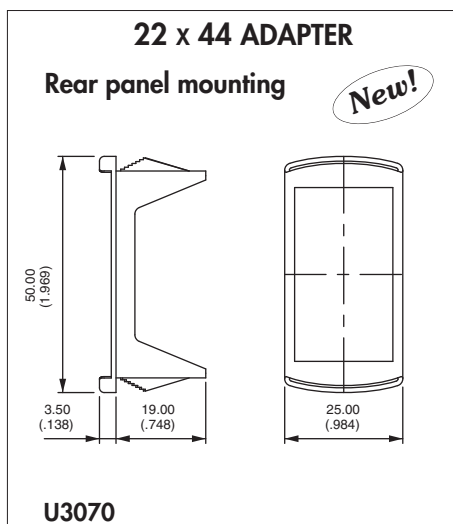
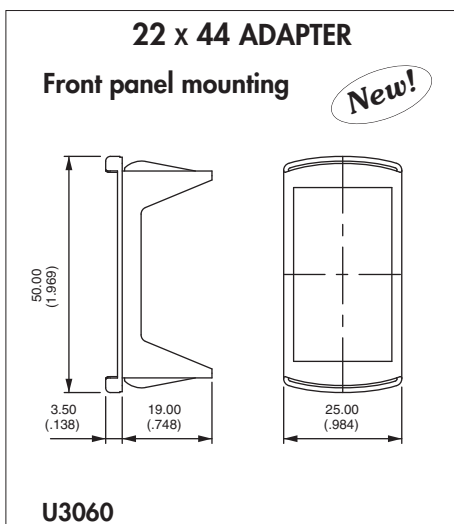
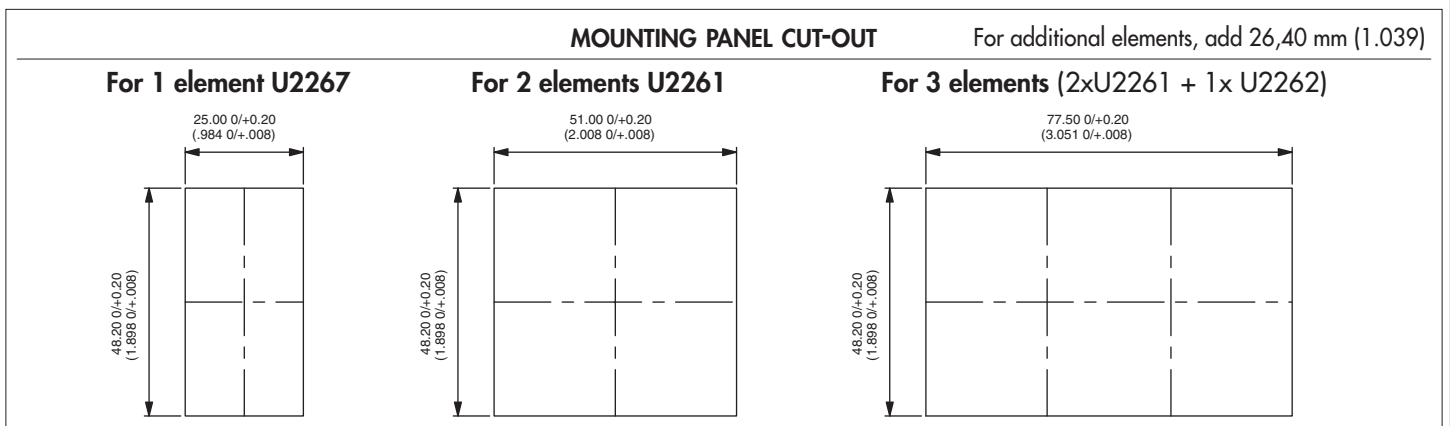

Adapter colours (replace 0 with code)
1/4 : dark blue - **2** : black - **4** : grey
5 : yellow - **6** : red - **7/1** : white

Recommended panel thickness : 0,60 mm to 1,50 mm

Recommended panel thickness : 1,60 mm -0,1/0 to 5,60 mm -0,1/0 in stages of 0,40 mm

K range

Power rocker switches and indicators

Accessories for KR, KL and KI series

ACTUATOR REMOVING TOOL



U3052

2 tools are supplied

EXTRACT ACTUATOR (KR ONLY)

Allows the extraction of the rocker / rocker support assembly. Place the 2 claws under the support and push as indicated by the arrow.

EXTRACT ROCKER (KR ONLY)

Allows to separate the rocker from its support.

Insert the tool between rocker and support as indicated by the arrow. Pull out the tool in the opposite direction.

EXTRACT SWITCH (KR, KL AND KI)

Allows to extract switch from panel mounting units. 2 tools are necessary.

Insert the tools between switch and panel mounting units from the rear to compress the snap-in device. Pull off switch manually.

CONNECTORS

Standard colour : black. Other colours : on request.

Connectors cannot be combined with wiring types H and I.

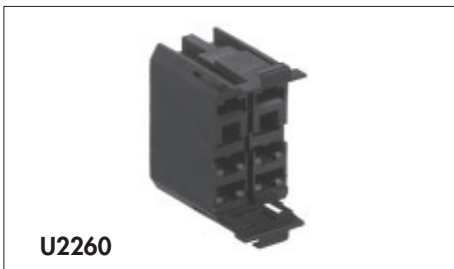

U2260

6 terminal version

For use with terminals type 2, 3, 4 or 5.
6,35 (1/4) tabs to be fitted by the user
(example : AMP/Tyco 0-0141013-2).
Can be used for the KG series.

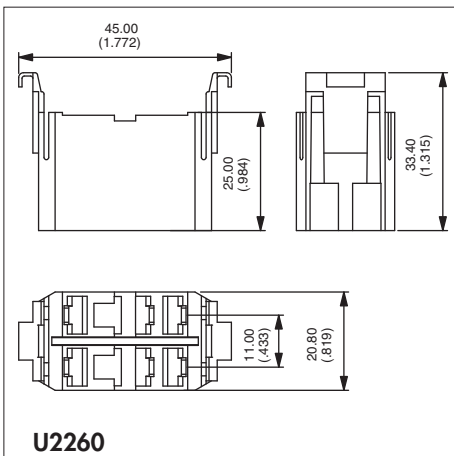

U2260



U2282

10 terminal version

For use with terminals type H or J.
2,8 (.110) tabs to be fitted by the user
(example : AMP/Tyco 0-927779-3).

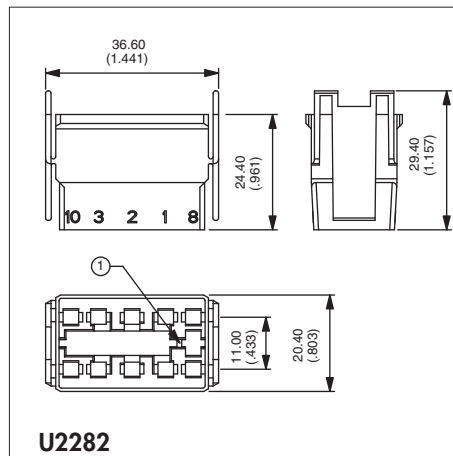

U2282



U2292

10 terminal version

For use with terminals type B, C, E or F.
6,35 (1/4) tabs to be fitted by the user
(example : AMP/Tyco 0-0141013-2).

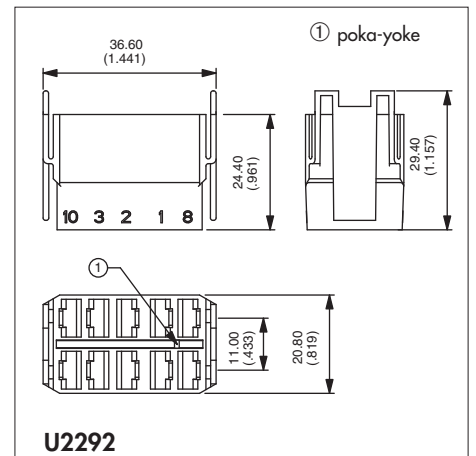

U2292

K range

Power rocker switches and indicators

Accessories for KR, KL and KI series

HOLE PLUGS

Usefull for future extensions.

| Code | Colour | Code | Colour |
|---------|-----------|-------|--------|
| U2271 | Blue | U2274 | Grey |
| U2271/4 | Dark blue | U2275 | Yellow |
| U2272 | Black | U2276 | Red |
| U2273 | Green | U2277 | Ivory |
| | | U2279 | Orange |

Recommended panel thickness :
1,50 mm to 6 mm

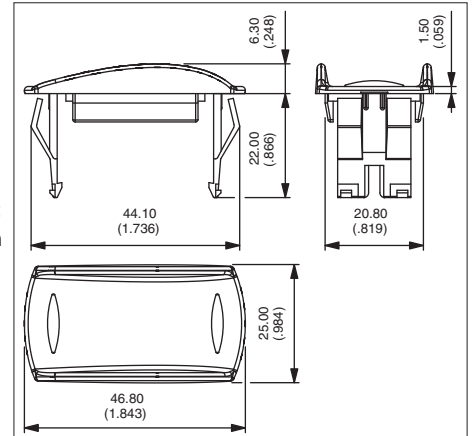

Connectors can be hanged on specific hole plugs. Contact APEM.