

- ▼ Capable of 2.5V Gate Drive
- ▼ Lower Gate Charge
- ▼ Fast Switching Performance
- ▼ RoHS Compliant & Halogen-Free

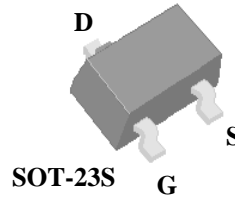

$BV_{DSS}$	20V
$R_{DS(ON)}$	75m $\Omega$
$I_D$	3.5A

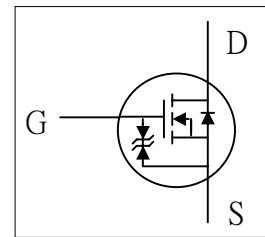

## Description

XP2N075E series are innovated design and silicon process technology to achieve the lowest possible on-resistance and fast switching performance. It provides the designer with an extreme efficient device for use in a wide range of power applications.

The SOT-23S package is widely preferred for commercial-industrial surface mount applications and suited for low voltage applications such as DC/DC converters.

## Absolute Maximum Ratings @ $T_J=25^\circ\text{C}$ (unless otherwise specified)

Symbol	Parameter	Rating	Units
$V_{DS}$	Drain-Source Voltage	20	V
$V_{GS}$	Gate-Source Voltage	$\pm 12$	V
$I_D @ T_A=25^\circ\text{C}$	Drain Current <sup>3</sup> , $V_{GS}$ @ 4.5V	3.5	A
$I_D @ T_A=70^\circ\text{C}$	Drain Current <sup>3</sup> , $V_{GS}$ @ 4.5V	2.8	A
$I_{DM}$	Pulsed Drain Current <sup>1</sup>	10	A
$P_D @ T_A=25^\circ\text{C}$	Total Power Dissipation	1.25	W
$T_{STG}$	Storage Temperature Range	-55 to 150	$^\circ\text{C}$
$T_J$	Operating Junction Temperature Range	-55 to 150	$^\circ\text{C}$

## Thermal Data

Symbol	Parameter	Value	Unit
Rthj-a	Maximum Thermal Resistance, Junction-ambient <sup>3</sup>	100	$^\circ\text{C}/\text{W}$

**Electrical Characteristics @T<sub>j</sub>=25°C(unless otherwise specified)**

Symbol	Parameter	Test Conditions	Min.	Typ.	Max.	Units
BV <sub>DSS</sub>	Drain-Source Breakdown Voltage	V <sub>GS</sub> =0V, I <sub>D</sub> =250uA	20	-	-	V
R <sub>DS(ON)</sub>	Static Drain-Source On-Resistance <sup>2</sup>	V <sub>GS</sub> =4.5V, I <sub>D</sub> =3.5A	-	-	75	mΩ
		V <sub>GS</sub> =2.5V, I <sub>D</sub> =1.2A	-	-	125	mΩ
V <sub>GS(th)</sub>	Gate Threshold Voltage	V <sub>DS</sub> =V <sub>GS</sub> , I <sub>D</sub> =250uA	0.5	-	1.2	V
g <sub>fs</sub>	Forward Transconductance	V <sub>DS</sub> =10V, I <sub>D</sub> =3A	-	16	-	S
I <sub>DSS</sub>	Drain-Source Leakage Current	V <sub>DS</sub> =16V, V <sub>GS</sub> =0V	-	-	10	uA
I <sub>GSS</sub>	Gate-Source Leakage	V <sub>GS</sub> = ±12V, V <sub>DS</sub> =0V	-	-	±30	uA
Q <sub>g</sub>	Total Gate Charge	I <sub>D</sub> =3A	-	6.5	10.4	nC
Q <sub>gs</sub>	Gate-Source Charge	V <sub>DS</sub> =10V	-	1	-	nC
Q <sub>gd</sub>	Gate-Drain ("Miller") Charge	V <sub>GS</sub> =4.5V	-	1.6	-	nC
t <sub>d(on)</sub>	Turn-on Delay Time	V <sub>DS</sub> =10V	-	6	-	ns
t <sub>r</sub>	Rise Time	I <sub>D</sub> =1A	-	11	-	ns
t <sub>d(off)</sub>	Turn-off Delay Time	R <sub>G</sub> =3.3Ω	-	14	-	ns
t <sub>f</sub>	Fall Time	V <sub>GS</sub> =5V	-	2.5	-	ns
C <sub>iss</sub>	Input Capacitance	V <sub>GS</sub> =0V	-	520	832	pF
C <sub>oss</sub>	Output Capacitance	V <sub>DS</sub> =10V	-	65	-	pF
C <sub>rss</sub>	Reverse Transfer Capacitance	f=1.0MHz	-	60	-	pF

**Source-Drain Diode**

Symbol	Parameter	Test Conditions	Min.	Typ.	Max.	Units
V <sub>SD</sub>	Forward On Voltage <sup>2</sup>	I <sub>S</sub> =1A, V <sub>GS</sub> =0V	-	-	1.2	V
t <sub>rr</sub>	Reverse Recovery Time	I <sub>S</sub> =3A, V <sub>GS</sub> =0V,	-	6	-	ns
Q <sub>rr</sub>	Reverse Recovery Charge	dI/dt=100A/μs	-	1.5	-	nC

**Notes:**

- 1.Pulse width limited by Max. junction temperature.
- 2.Pulse test
- 3.Surface mounted on 1 in<sup>2</sup> copper pad of FR4 board, t ≤ 10s ; 300°C/W when mounted on min. copper pad.

THIS PRODUCT IS SENSITIVE TO ELECTROSTATIC DISCHARGE, PLEASE HANDLE WITH CAUTION.

USE OF THIS PRODUCT AS A CRITICAL COMPONENT IN LIFE SUPPORT OR OTHER SIMILAR SYSTEMS IS NOT AUTHORIZED.

XSEMI DOES NOT ASSUME ANY LIABILITY ARISING OUT OF THE APPLICATION OR USE OF ANY PRODUCT OR CIRCUIT DESCRIBED HEREIN; NEITHER DOES IT CONVEY ANY LICENSE UNDER ITS PATENT RIGHTS, NOR THE RIGHTS OF OTHERS.

XSEMI RESERVES THE RIGHT TO MAKE CHANGES WITHOUT FURTHER NOTICE TO ANY PRODUCTS HEREIN TO IMPROVE RELIABILITY, FUNCTION OR DESIGN.

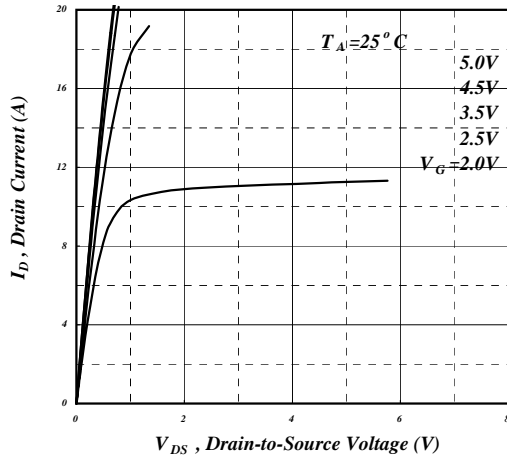

**Fig 1. Typical Output Characteristics**

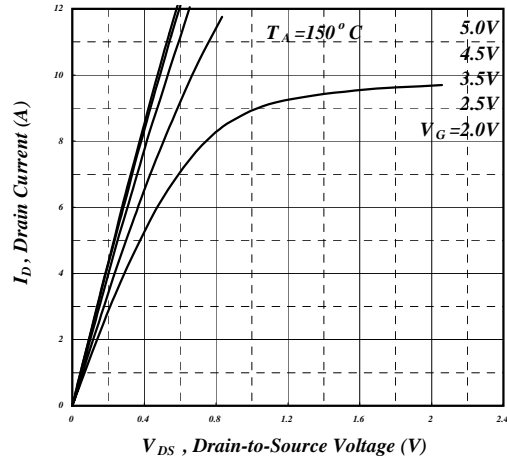

**Fig 2. Typical Output Characteristics**

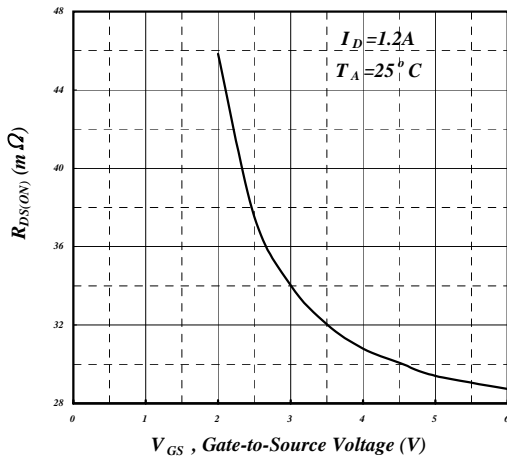

**Fig 3. On-Resistance v.s. Gate Voltage**

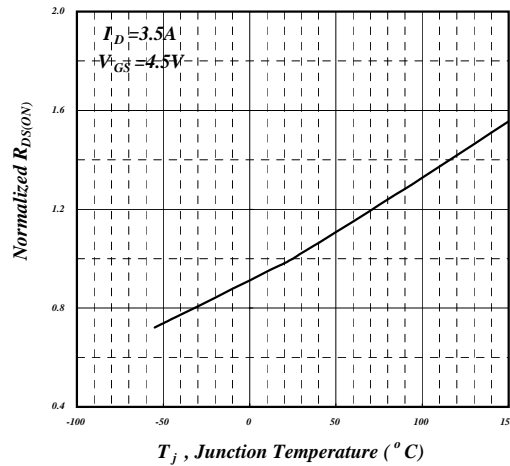

**Fig 4. Normalized On-Resistance v.s. Junction Temperature**

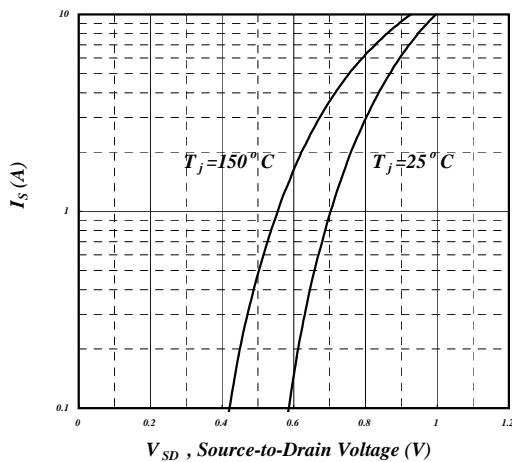

**Fig 5. Forward Characteristic of Reverse Diode**

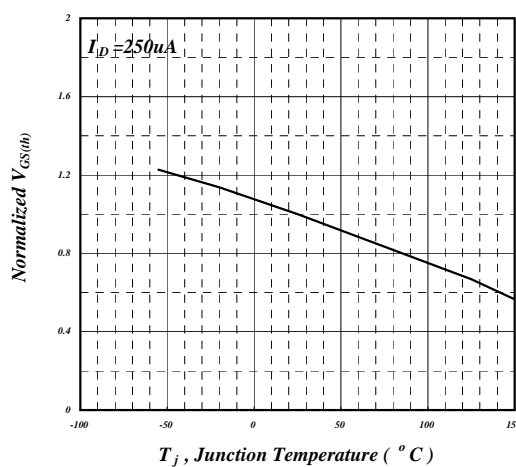

**Fig 6. Gate Threshold Voltage v.s. Junction Temperature**

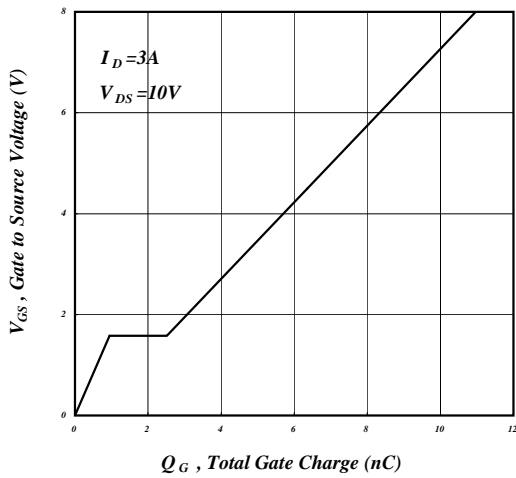

**Fig 7. Gate Charge Characteristics**

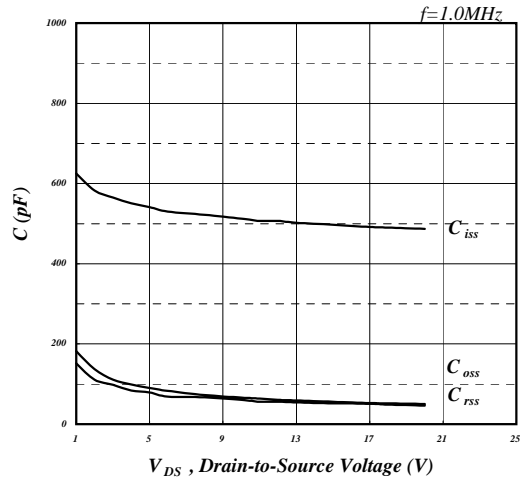

**Fig 8. Typical Capacitance Characteristics**

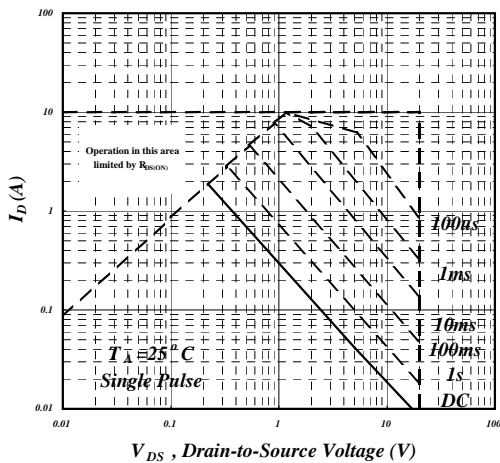

**Fig 9. Maximum Safe Operating Area**

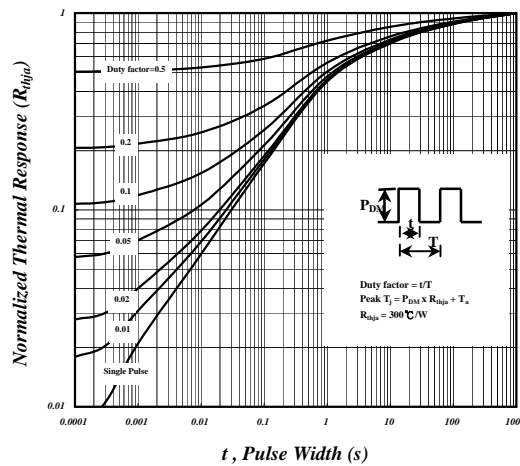

**Fig 10. Effective Transient Thermal Impedance**

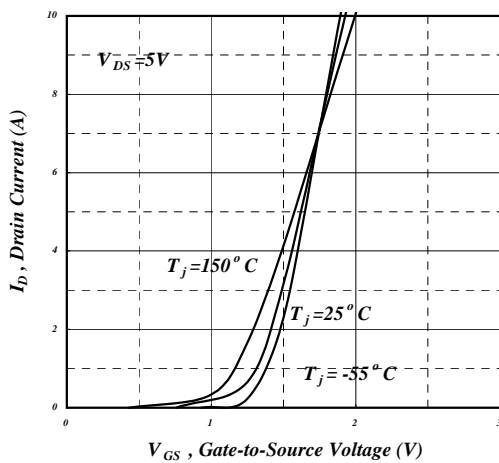

**Fig 11. Transfer Characteristics**

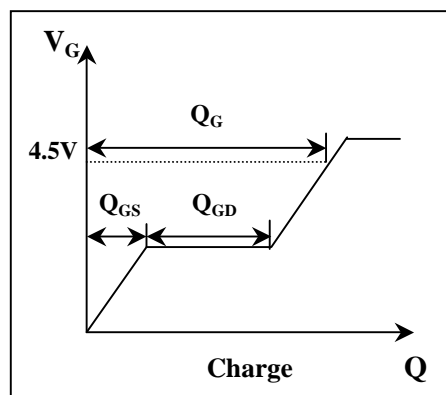

**Fig 12. Gate Charge Circuit**

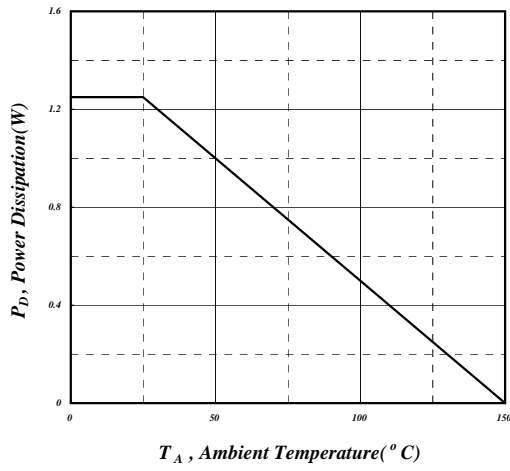

**Fig 13. Total Power Dissipation**

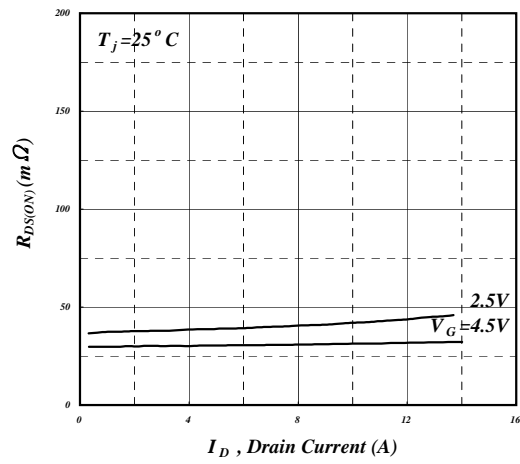

**Fig 14. Typ. Drain-Source on State Resistance**

---

**MARKING INFORMATION**

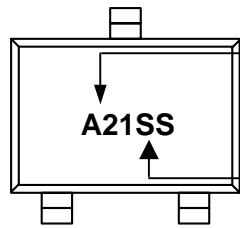

Part Number : A21

Date Code : SS

SS:2004,2008,2012,2016,2020,2024...

SS:2003,2007,2011,2015,2019,2023...

SS:2002,2006,2010,2014,2018,2022...

SS:2001,2005,2009,2013,2017,2021...

**Package Outline : SOT-23S**

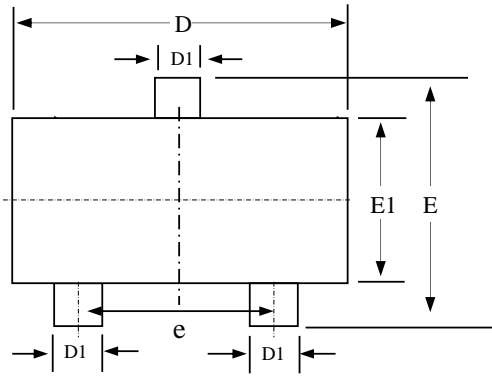

SYMBOLS	Millimeters		
	MIN	NOM	MAX
A	0.80	1.00	1.20
A1	0.00	—	0.10
A2	0.05	—	0.20
D1	0.30	0.40	0.50
e	1.80	1.90	2.00
D	2.80	2.90	3.10
E	2.10	2.40	2.70
E1	1.20	1.30	1.40
M	0°	5°	10°
L	0.20	—	0.60

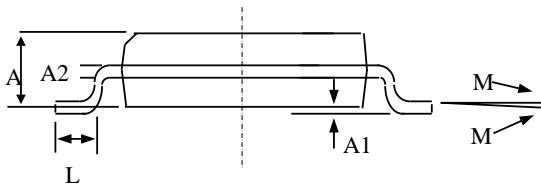

- 1.All Dimension Are In Millimeters.
- 2.Dimension Does Not Include Mold Protrusions.

**SOT-23S FOOTPRINT :**

