

AMY-50-M-C

~24° medium beam. Assembly with holder C compatible with LEDiL HEKLA. Black version.

SPECIFICATION:

Dimensions	Ø 49.9 mm
Height	13.1 mm
Fastening	socket
ROHS compliant	yes ⓘ



MATERIALS:

Component	Type	Material	Colour	Finish
AMY-50-M	Single lens	PMMA	clear	
AMY-50-HLD-C	Holder	PC	black	





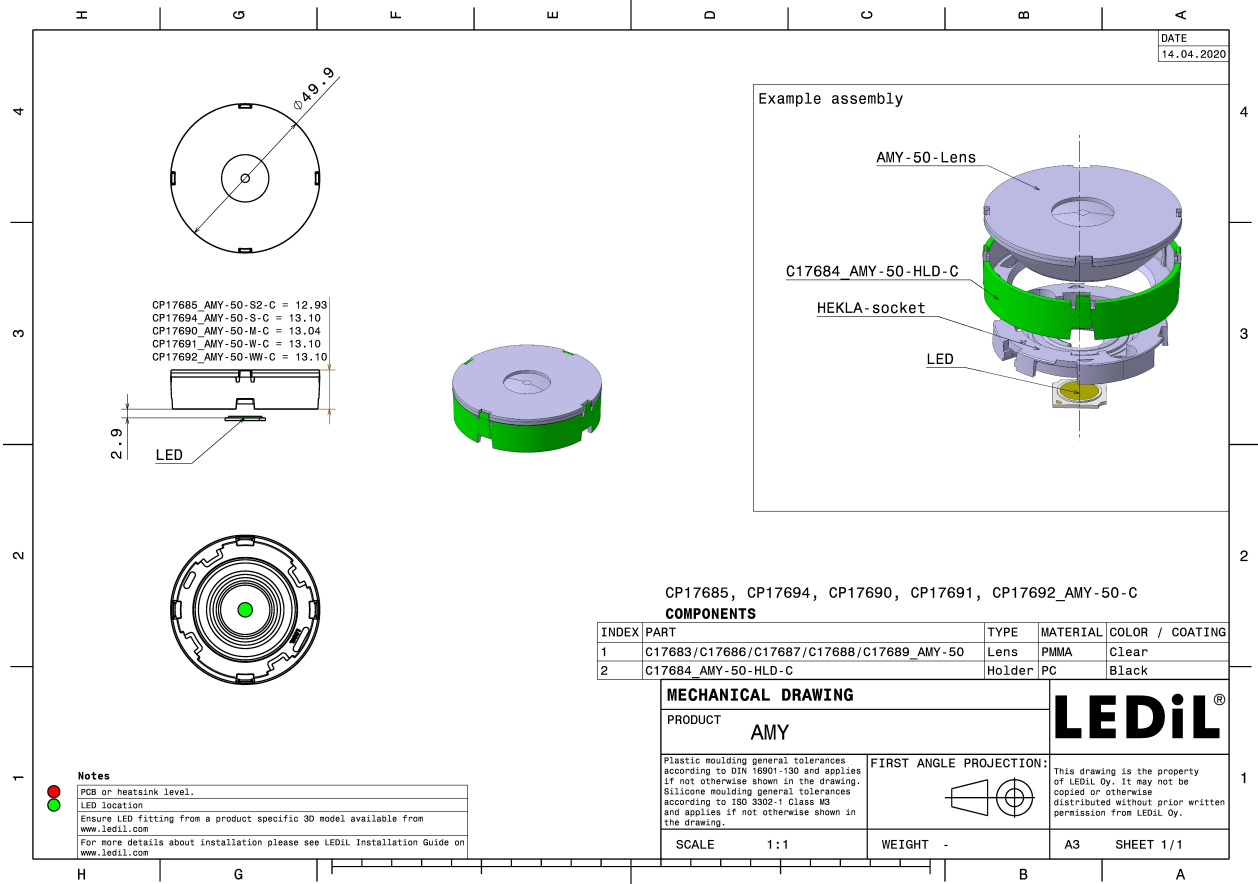



ORDERING INFORMATION:

Component	Qty in box	MOQ	MPQ	Box weight (kg)
CP17690_AMY-50-M-C » Box size: 480 x 280 x 300 mm	510	120	30	9.1

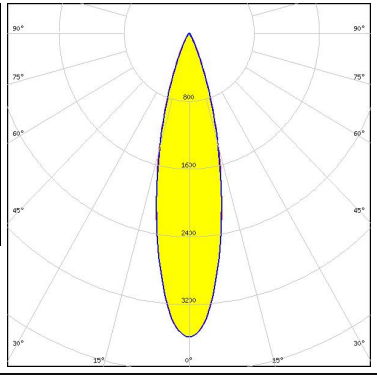

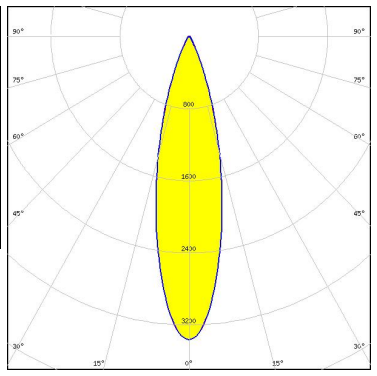

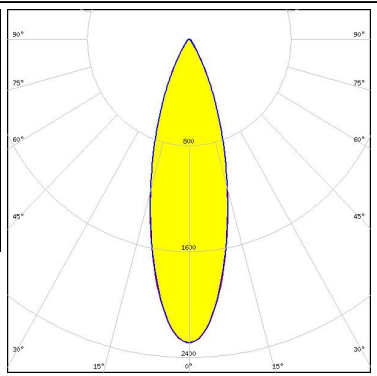

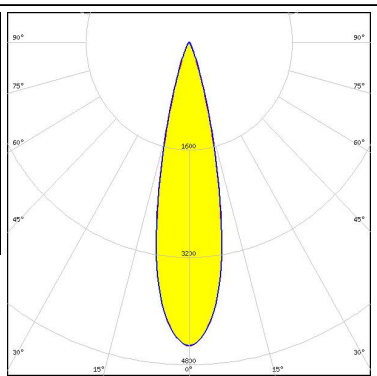



See also our general installation guide: www.ledil.com/installation_guide

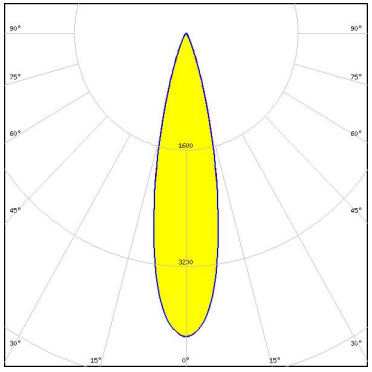

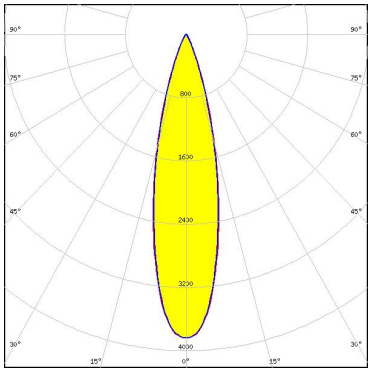

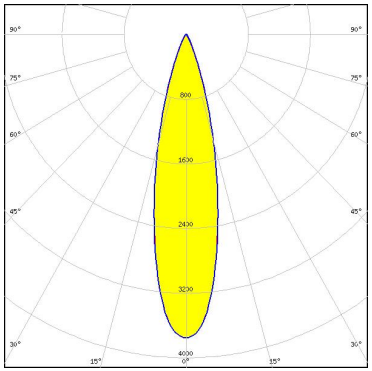

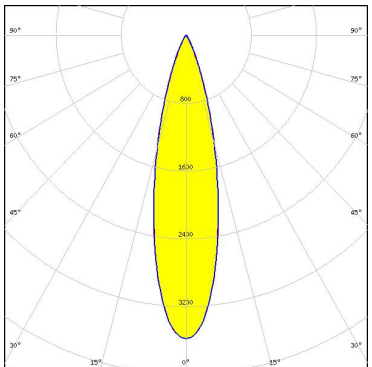

OPTICAL RESULTS (MEASURED):

<p></p> <p>LED V10 Gen 8 FWHM / FWTM 26.0° / 48.0° Efficiency 91 % Peak intensity 3.6 cd/lm LEDs/each optic 1 Light colour White Required components: F15255_HEKLA-SOCKET-C</p>		
<p></p> <p>LED V11 HD Gen 8 FWHM / FWTM 26.0° / 50.0° Efficiency 91 % Peak intensity 3.4 cd/lm LEDs/each optic 1 Light colour White Required components: Bender Wirth: 633d Hekla</p>		
<p></p> <p>LED V13 Gen 8 FWHM / FWTM 31.0° / 60.0° Efficiency 88 % Peak intensity 2.3 cd/lm LEDs/each optic 1 Light colour White Required components: F15859_HEKLA-SOCKET-I</p>		
<p></p> <p>LED V4 HD Gen 7 FWHM / FWTM 24.0° / 41.0° Efficiency 93 % Peak intensity 4.5 cd/lm LEDs/each optic 1 Light colour White Required components: F15253_HEKLA-SOCKET-A</p>		

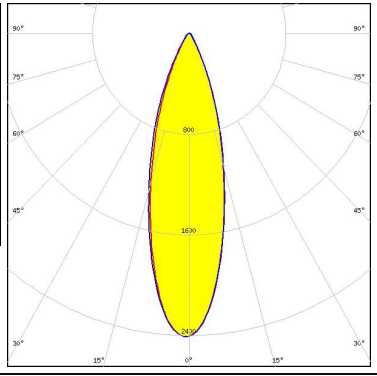

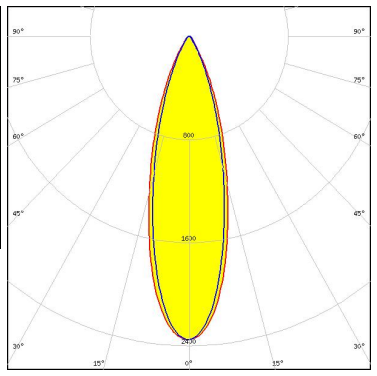

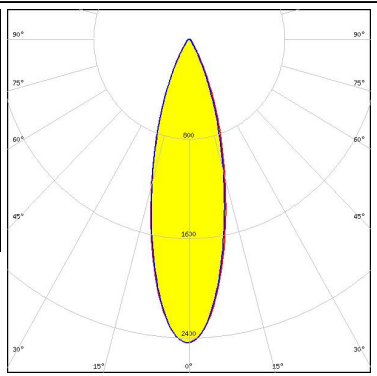

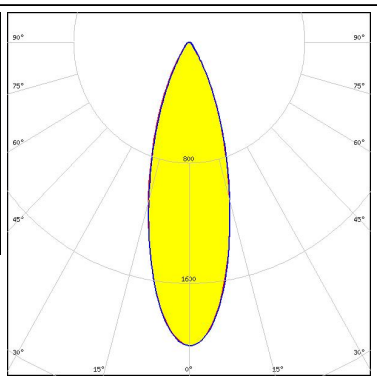

OPTICAL RESULTS (MEASURED):

<p></p> <p>LED V6 HD Gen 7</p> <p>FWHM / FWTM 24.0° / 43.0°</p> <p>Efficiency 91 %</p> <p>Peak intensity 4.2 cd/m</p> <p>LEDs/each optic 1</p> <p>Light colour White</p> <p>Required components: F15255_HEKLA-SOCKET-C</p>		
<p></p> <p>LED V8 Gen 8</p> <p>FWHM / FWTM 25.0° / 46.0°</p> <p>Efficiency 92 %</p> <p>Peak intensity 3.8 cd/m</p> <p>LEDs/each optic 1</p> <p>Light colour White</p> <p>Required components: F15253_HEKLA-SOCKET-A</p>		
<p></p> <p>LED V9 HD Gen7</p> <p>FWHM / FWTM 25.0° / 46.0°</p> <p>Efficiency 90 %</p> <p>Peak intensity 3.8 cd/m</p> <p>LEDs/each optic 1</p> <p>Light colour White</p> <p>Required components: F15859_HEKLA-SOCKET-I</p>		
<p></p> <p>LED VERO10</p> <p>FWHM / FWTM 25.0° / 47.0°</p> <p>Efficiency 90 %</p> <p>Peak intensity 3.6 cd/m</p> <p>LEDs/each optic 1</p> <p>Light colour White</p> <p>Required components: F15616_HEKLA-SOCKET-F</p>		

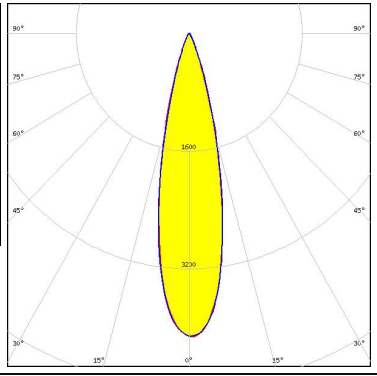
OPTICAL RESULTS (MEASURED):

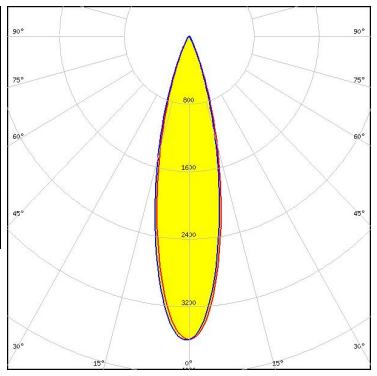
<p></p> <p>LED Vesta DTW 13mm (21W) FWHM / FWTM 30.0° / 57.0° Efficiency 86 % Peak intensity 2.4 cd/m LEDs/each optic 1 Light colour White</p> <p>Required components: C16142_HEKLA-SOCKET-K Bender Wirth: 491 Typ L8</p>		
<p></p> <p>LED Vesta DTW 15mm (33W) FWHM / FWTM 29.0° / 58.0° Efficiency 86 % Peak intensity 2.4 cd/m LEDs/each optic 1 Light colour White</p> <p>Required components: C16142_HEKLA-SOCKET-K Bender Wirth: 491 Typ L8</p>		
<p></p> <p>LED Vesta TW 13mm (18W) DP FWHM / FWTM 29.0° / 58.0° Efficiency 87 % Peak intensity 2.4 cd/m LEDs/each optic 1 Light colour Tunable White</p> <p>Required components: C16142_HEKLA-SOCKET-K Bender Wirth: 492 Typ L8</p>		
<p></p> <p>LED Vesta TW 15mm DP FWHM / FWTM 32.0° / 63.0° Efficiency 86 % Peak intensity 2 cd/m LEDs/each optic 1 Light colour Tunable White</p> <p>Required components: C16142_HEKLA-SOCKET-K Bender Wirth: 482 Typ L8</p>		

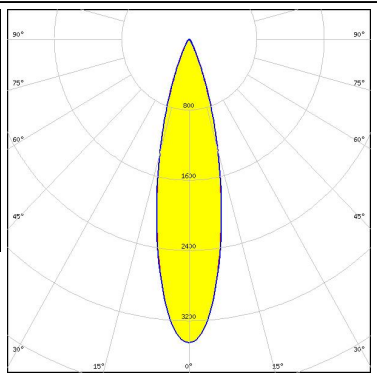
OPTICAL RESULTS (MEASURED):

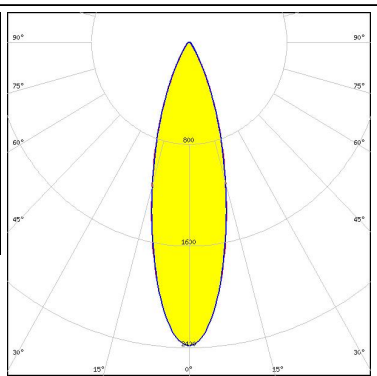
<p></p> <p>LED Vesta TW 6mm DP FWHM / FWTM 24.0° / 43.0° Efficiency 90 % Peak intensity 4.1 cd/m LEDs/each optic 1 Light colour Tunable White</p> <p>Required components: C16142_HEKLA-SOCKET-K Bender Wirth: 504 Typ L8</p>		
<p></p> <p>LED Vesta TW 9mm (9W) DP FWHM / FWTM 25.0° / 47.0° Efficiency 89 % Peak intensity 3.6 cd/m LEDs/each optic 1 Light colour Tunable White</p> <p>Required components: C16142_HEKLA-SOCKET-K Bender Wirth: 489 Typ L8</p>		
<p>CITIZEN</p> <p>LED CLL02x/CLU02x (LES10) FWHM / FWTM 25.0° / 48.0° Efficiency 89 % Peak intensity 3.5 cd/m LEDs/each optic 1 Light colour White</p> <p>Required components: F17435_HEKLA-G2-C</p>		
<p>CITIZEN</p> <p>LED CLL03x/CLU03x FWHM / FWTM 29.0° / 58.0° Efficiency 87 % Peak intensity 2.4 cd/m LEDs/each optic 1 Light colour White</p> <p>Required components: F17438_HEKLA-G2-I</p>		

OPTICAL RESULTS (MEASURED):

CITIZEN

LED CLU700/701/702/703
 FWHM / FWTM 24.0° / 43.0°
 Efficiency 90 %
 Peak intensity 4.1 cd/lm
 LEDs/each optic 1
 Light colour White
 Required components:
 F17435_HEKLA-G2-C

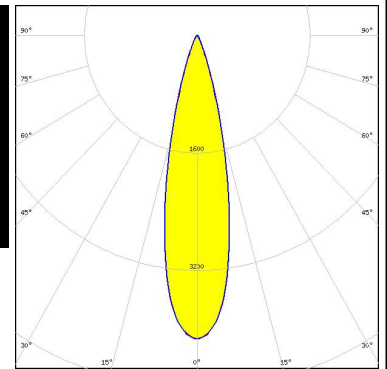

CITIZEN

LED CLU7A2/7A3
 FWHM / FWTM 24.0° / 40.0°
 Efficiency 90 %
 Peak intensity 4.4 cd/lm
 LEDs/each optic 1
 Light colour White
 Required components:
 F17435_HEKLA-G2-C

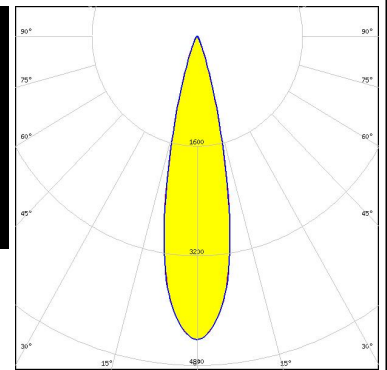

CITIZEN

LED CLU7B2
 FWHM / FWTM 24.0° / 39.0°
 Efficiency 91 %
 Peak intensity 4.6 cd/lm
 LEDs/each optic 1
 Light colour White
 Required components:
 F17435_HEKLA-G2-C

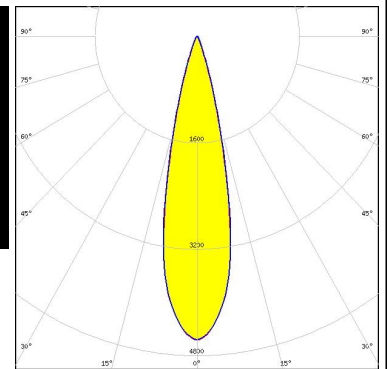
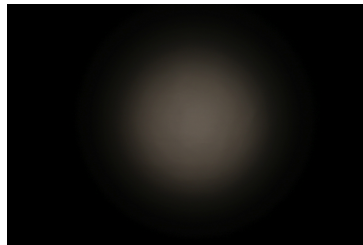





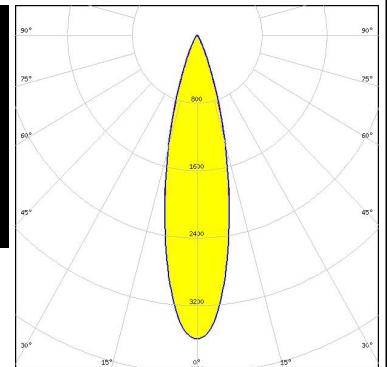
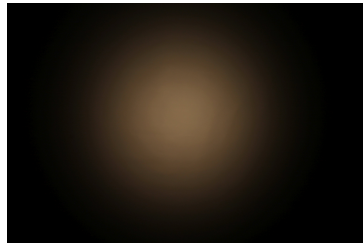

CREE LED

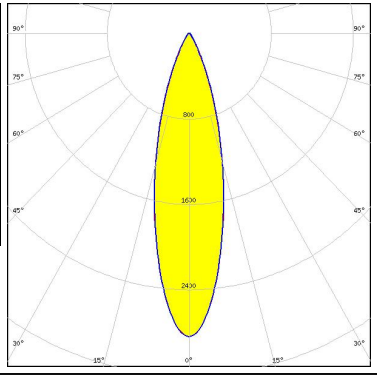
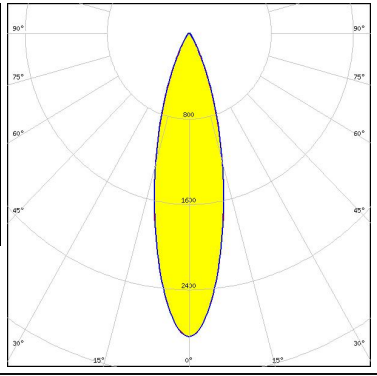
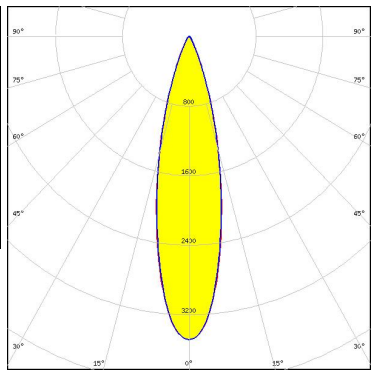

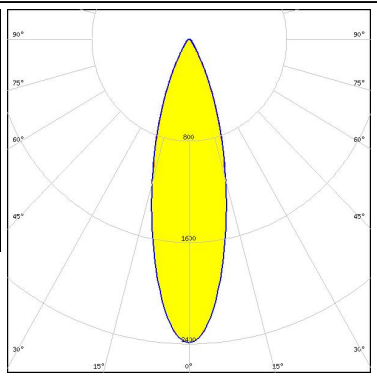

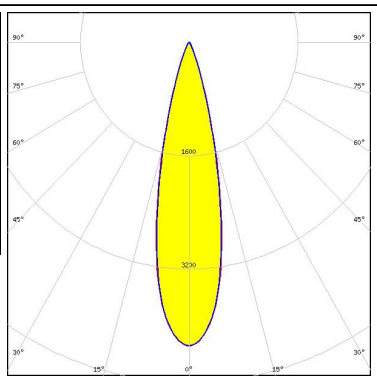
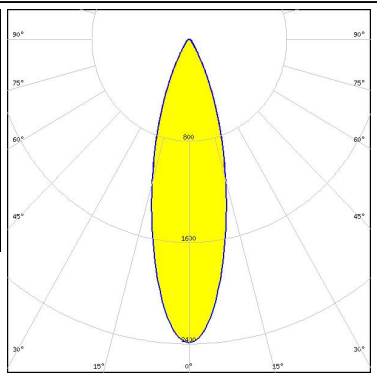

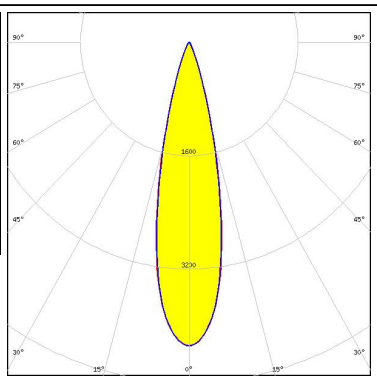
LED CMA1516
 FWHM / FWTM 25.0° / 47.0°
 Efficiency 90 %
 Peak intensity 3.6 cd/lm
 LEDs/each optic 1
 Light colour White
 Required components:
 F17436_HEKLA-G2-D



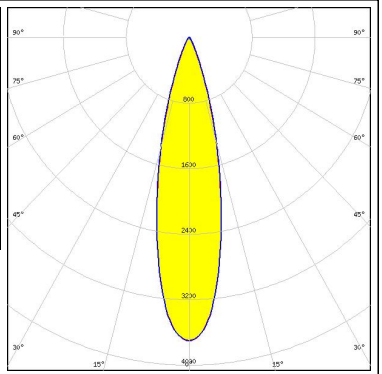

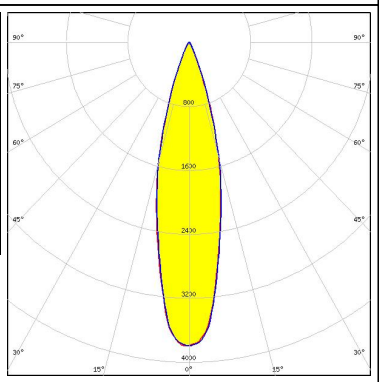

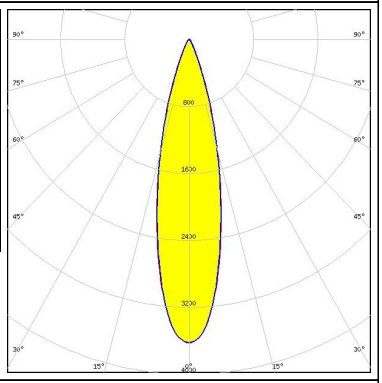
OPTICAL RESULTS (MEASURED):

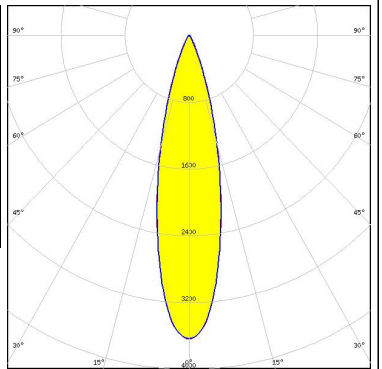
<p>CREE  LED</p> <p>LED CMA1825 FWHM / FWTM 27.0° / 54.0° Efficiency 89 % Peak intensity 2.8 cd/m LEDs/each optic 1 Light colour White Required components: F15254_HEKLA-SOCKET-B</p>		
<p>CREE  LED</p> <p>LED CMT14xx FWHM / FWTM 25.0° / 48.0° Efficiency 89 % Peak intensity 3.5 cd/m LEDs/each optic 1 Light colour White Required components: F17435_HEKLA-G2-C</p>		
<p>CREE  LED</p> <p>LED CMT19xx FWHM / FWTM 29.0° / 58.0° Efficiency 87 % Peak intensity 2.4 cd/m LEDs/each optic 1 Light colour White Required components: F17438_HEKLA-G2-I</p>		
<p>CREE  LED</p> <p>LED CXA/B 13xx FWHM / FWTM 24.0° / 42.0° Efficiency 91 % Peak intensity 4.3 cd/m LEDs/each optic 1 Light colour White Required components: F17439_HEKLA-G2-J</p>		



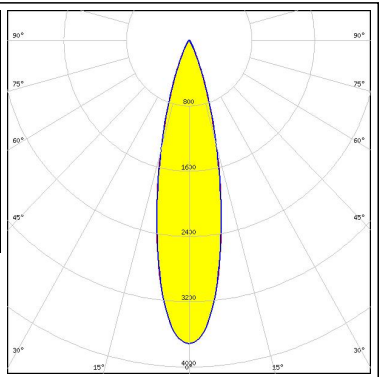

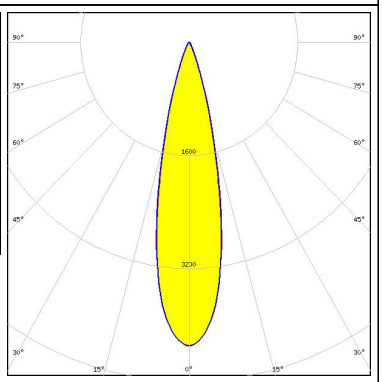
OPTICAL RESULTS (MEASURED):

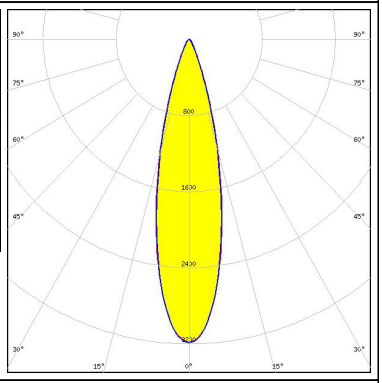
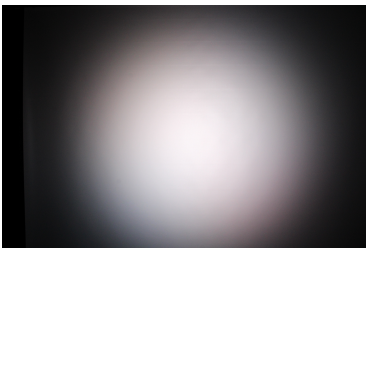
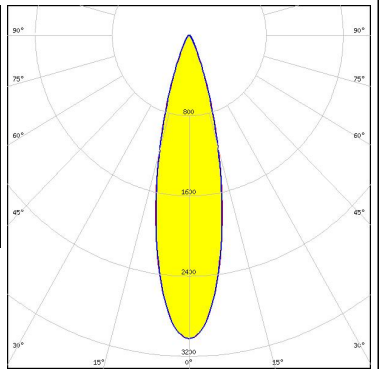
<p>CREE LED</p> <p>LED CXA/B 15xx FWHM / FWTM 25.0° / 46.0° Efficiency 90 % Peak intensity 3.7 cd/m LEDs/each optic 1 Light colour White Required components: F17436_HEKLA-G2-D</p>		
<p>LEDIM</p> <p>LED LEDIM/C6 FWHM / FWTM 26.0° / 46.0° Efficiency 90 % Peak intensity 3.8 cd/m LEDs/each optic 9 Light colour White Required components: F17438_HEKLA-G2-I</p>		
<p>LUMILEDS</p> <p>LED LUXEON CoB 1202/1203 FWHM / FWTM 25.0° / 46.0° Efficiency 89 % Peak intensity 3.6 cd/m LEDs/each optic 1 Light colour White Required components: F17437_HEKLA-G2-H</p>		
<p>LUMILEDS</p> <p>LED LUXEON CoB 1204HD FWHM / FWTM 25.0° / 47.0° Efficiency 89 % Peak intensity 3.6 cd/m LEDs/each optic 1 Light colour White Required components: F17437_HEKLA-G2-H</p>		

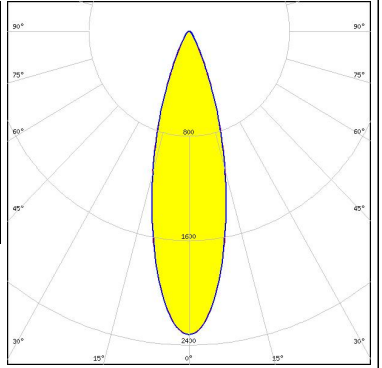

OPTICAL RESULTS (MEASURED):

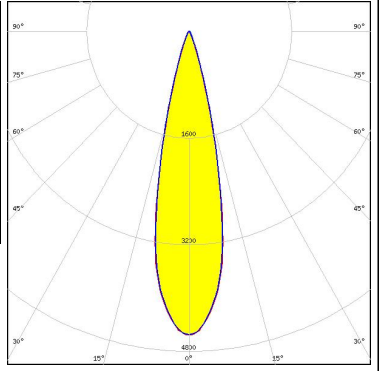
<p>LUMILEDS</p> <p>LED LUXEON CoB M02/M03</p> <p>FWHM / FWTM 25.0° / 47.0°</p> <p>Efficiency 90 %</p> <p>Peak intensity 3.7 cd/m</p> <p>LEDs/each optic 1</p> <p>Light colour White</p> <p>Required components: F17436_HEKLA-G2-D</p>		
<p>LUMILEDS</p> <p>LED LUXEON CoB S01</p> <p>FWHM / FWTM 24.0° / 42.0°</p> <p>Efficiency 91 %</p> <p>Peak intensity 4.3 cd/m</p> <p>LEDs/each optic 1</p> <p>Light colour White</p> <p>Required components: F17439_HEKLA-G2-J</p>		
<p>LUMILEDS</p> <p>LED LUXEON Fusion 12-up (20x24)</p> <p>FWHM / FWTM 25.0° / 47.0°</p> <p>Efficiency 83 %</p> <p>Peak intensity 3.2 cd/m</p> <p>LEDs/each optic 12</p> <p>Light colour White</p> <p>Required components: C16142_HEKLA-SOCKET-K F18158_HEKLA-RZ-LENS Bender Wirth: 442 Typ L8</p>		
<p>LUMILEDS</p> <p>LED LUXEON Fusion 21-up (20x24)</p> <p>FWHM / FWTM 26.0° / 48.0°</p> <p>Efficiency 82 %</p> <p>Peak intensity 3 cd/m</p> <p>LEDs/each optic 21</p> <p>Light colour White</p> <p>Required components: C16142_HEKLA-SOCKET-K F18158_HEKLA-RZ-LENS Bender Wirth: 442 Typ L8</p>		

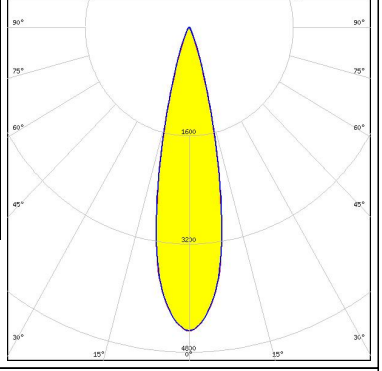
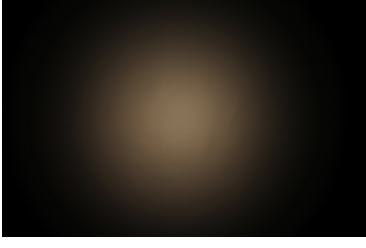
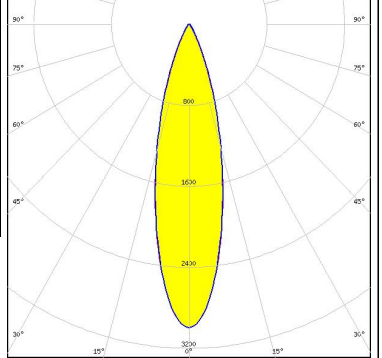
OPTICAL RESULTS (MEASURED):

<p>LUMILEDS</p> <p>LED LUXEON Fusion 27-up (20x24)</p> <p>FWHM / FWTM 29.0° / 55.0°</p> <p>Efficiency 80 %</p> <p>Peak intensity 2.3 cd/lm</p> <p>LEDs/each optic 27</p> <p>Light colour White</p> <p>Required components: C16142_HEKLA-SOCKET-K F18158_HEKLA-RZ-LENS Bender Wirth: 442 Typ L8</p>		
<p>LUMINUS</p> <p>LED CXM-3</p> <p>FWHM / FWTM 24.0° / 40.0°</p> <p>Efficiency 91 %</p> <p>Peak intensity 4.6 cd/lm</p> <p>LEDs/each optic 1</p> <p>Light colour White</p> <p>Required components: F17435_HEKLA-G2-C</p>		
<p>LUMINUS</p> <p>LED CXM-4</p> <p>FWHM / FWTM 24.0° / 40.0°</p> <p>Efficiency 91 %</p> <p>Peak intensity 4.5 cd/lm</p> <p>LEDs/each optic 1</p> <p>Light colour White</p> <p>Required components: F17435_HEKLA-G2-C</p>		
<p>NICHIA</p> <p>LED COB L-Type (LES 11)</p> <p>FWHM / FWTM 27.0° / 52.0°</p> <p>Efficiency 88 %</p> <p>Peak intensity 3 cd/lm</p> <p>LEDs/each optic 1</p> <p>Light colour White</p> <p>Required components: F17437_HEKLA-G2-H</p>		

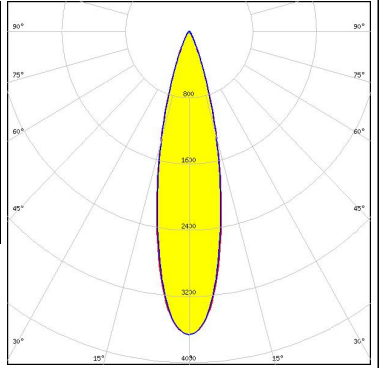
OPTICAL RESULTS (MEASURED):

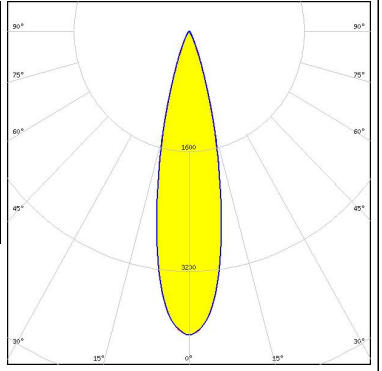
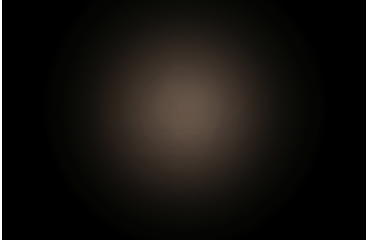
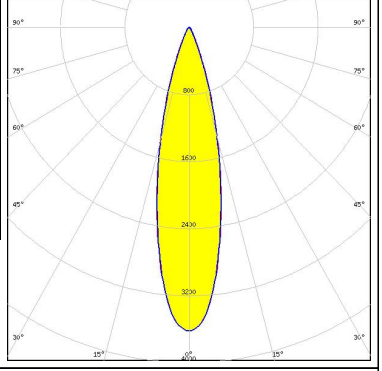
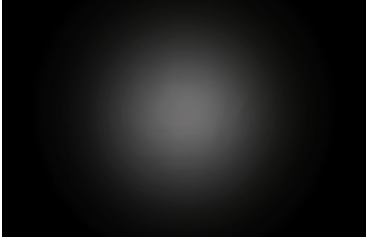
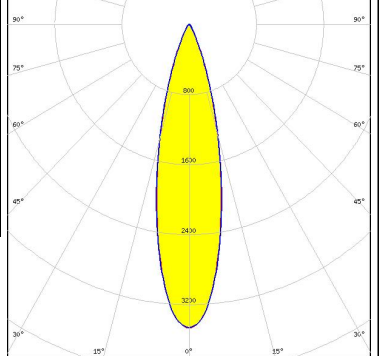
<p>NICHIA</p> <p>LED COB L-Type (LES 9)</p> <p>FWHM / FWTM 25.0° / 46.0°</p> <p>Efficiency 89 %</p> <p>Peak intensity 3.7 cd/lm</p> <p>LEDs/each optic 1</p> <p>Light colour White</p> <p>Required components: F17437_HEKLA-G2-H</p>		
<p>NICHIA</p> <p>LED COB S-Type (LES 7)</p> <p>FWHM / FWTM 24.0° / 44.0°</p> <p>Efficiency 91 %</p> <p>Peak intensity 4 cd/lm</p> <p>LEDs/each optic 1</p> <p>Light colour White</p> <p>Required components: F15848_HEKLA-SOCKET-G</p>		
<p>PHILIPS</p> <p>LED Fortimo SLM L09 CoB</p> <p>FWHM / FWTM 25.0° / 47.0°</p> <p>Efficiency 89 %</p> <p>Peak intensity 3.6 cd/lm</p> <p>LEDs/each optic 1</p> <p>Light colour White</p> <p>Required components: F17437_HEKLA-G2-H</p>		
<p>SAMSUNG</p> <p>LED LC003D / LC006D / LC009D / LC013D</p> <p>FWHM / FWTM 25.0° / 48.0°</p> <p>Efficiency 89 %</p> <p>Peak intensity 3.5 cd/lm</p> <p>LEDs/each optic 1</p> <p>Light colour White</p> <p>Required components: F17435_HEKLA-G2-C</p>		

OPTICAL RESULTS (MEASURED):

SAMSUNG

LED LC016D / LC019D / LC026D / LC033D
 FWHM / FWTM 31.0° / 62.0°
 Efficiency 87 %
 Peak intensity 2.1 cd/lm
 LEDs/each optic 1
 Light colour White
 Required components:
 F17438_HEKLA-G2-I

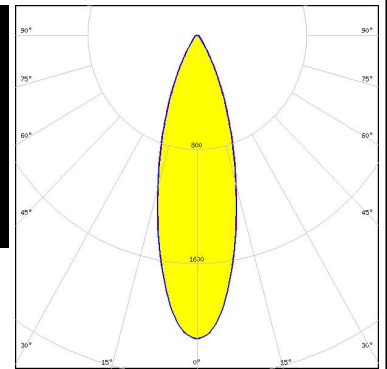

SAMSUNG

LED LC030C/040C G2
 FWHM / FWTM 26.0° / 52.0°
 Efficiency 88 %
 Peak intensity 3 cd/lm
 LEDs/each optic 1
 Light colour White
 Required components:
 F17438_HEKLA-G2-I

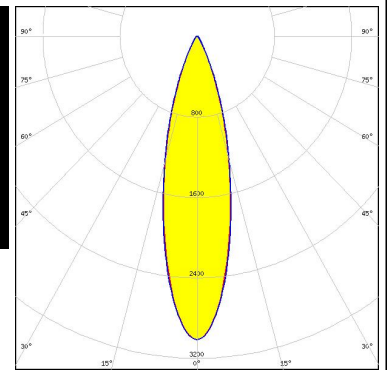
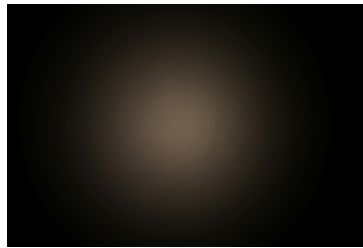



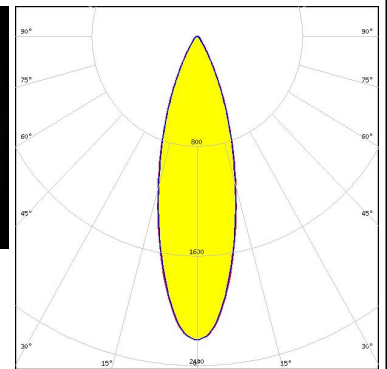
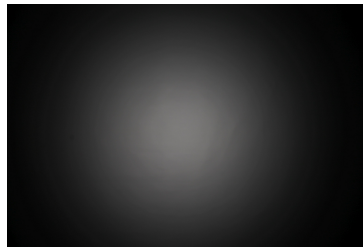



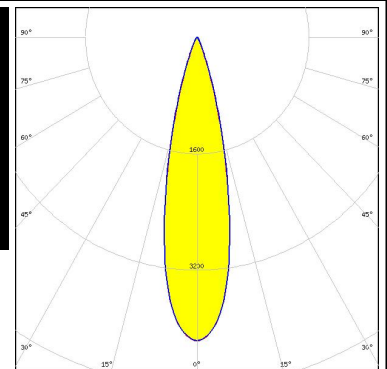
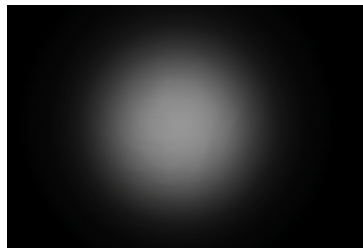

SEOUL SEMICONDUCTOR
 LED MJT COB LES 14.5
 FWHM / FWTM 30.0° / 60.0°
 Efficiency 87 %
 Peak intensity 2.2 cd/lm
 LEDs/each optic 1
 Light colour White
 Required components:
 F17438_HEKLA-G2-I



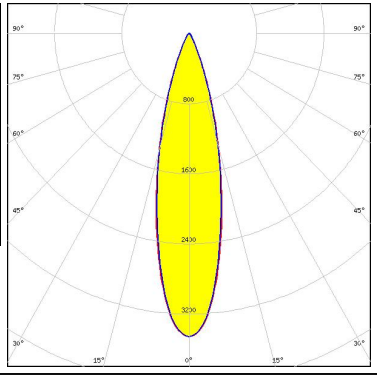

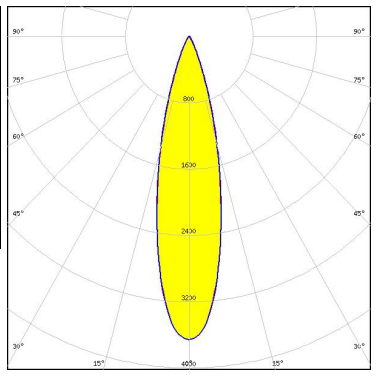

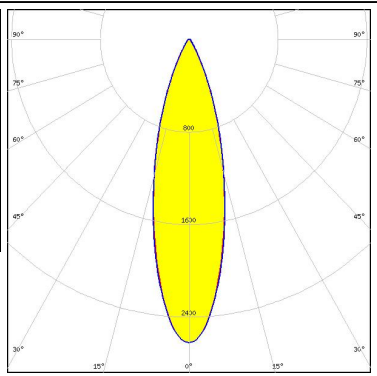
SEOUL SEMICONDUCTOR
 LED MJT COB LES 6
 FWHM / FWTM 24.0° / 42.0°
 Efficiency 91 %
 Peak intensity 4.2 cd/lm
 LEDs/each optic 1
 Light colour White
 Required components:
 F17435_HEKLA-G2-C

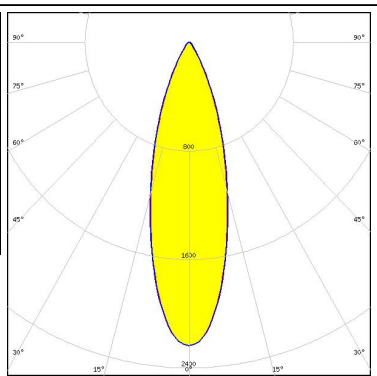

OPTICAL RESULTS (MEASURED):

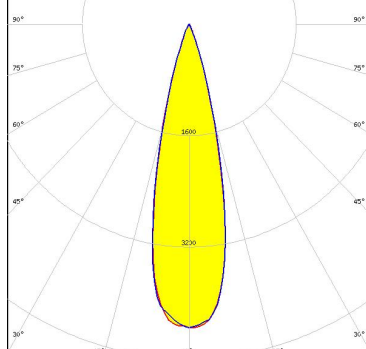
<p> SEUL SEMICONDUCTOR</p> <p>LED MJT COB LES 9.8</p> <p>FWHM / FWTM 25.0° / 48.0°</p> <p>Efficiency 90 %</p> <p>Peak intensity 3.5 cd/m</p> <p>LEDs/each optic 1</p> <p>Light colour White</p> <p>Required components: F17435_HEKLA-G2-C</p>		
<p>TRIDONIC</p> <p>LED SLE G7 LES09</p> <p>FWHM / FWTM 25.0° / 47.0°</p> <p>Efficiency 90 %</p> <p>Peak intensity 3.7 cd/m</p> <p>LEDs/each optic 1</p> <p>Light colour White</p> <p>Required components: F17435_HEKLA-G2-C</p>		
<p>TRIDONIC</p> <p>LED SLE G7 LES13</p> <p>FWHM / FWTM 28.0° / 55.0°</p> <p>Efficiency 87 %</p> <p>Peak intensity 2.6 cd/m</p> <p>LEDs/each optic 1</p> <p>Light colour White</p> <p>Required components: F17438_HEKLA-G2-I</p>		
<p>TRIDONIC</p> <p>LED SLE G7 LES15</p> <p>FWHM / FWTM 30.0° / 60.0°</p> <p>Efficiency 87 %</p> <p>Peak intensity 2.2 cd/m</p> <p>LEDs/each optic 1</p> <p>Light colour White</p> <p>Required components: F17438_HEKLA-G2-I</p>		

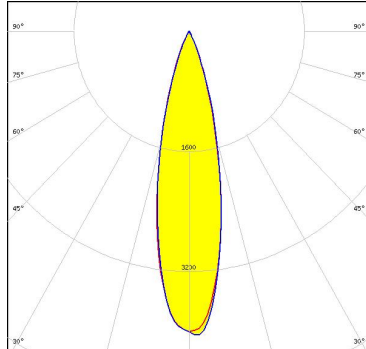
OPTICAL RESULTS (SIMULATED):

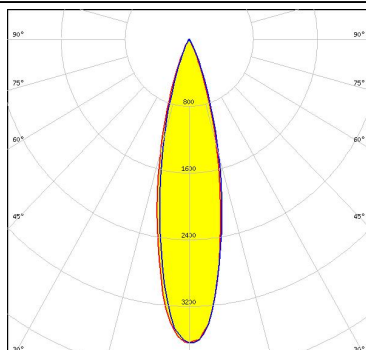
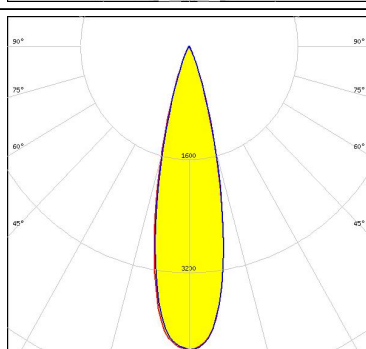
<p></p> <p>LED V4 HD Gen 7</p> <p>FWHM / FWTM 26.1° / 42.2°</p> <p>Efficiency 92 %</p> <p>Peak intensity 4.4 cd/lm</p> <p>LEDs/each optic 1</p> <p>Light colour White</p> <p>Required components: F15255_HEKLA-SOCKET-C</p>	
<p></p> <p>LED V8 Gen7</p> <p>FWHM / FWTM 24.0° / 46.0°</p> <p>Efficiency 90 %</p> <p>Peak intensity 4 cd/lm</p> <p>LEDs/each optic 1</p> <p>Light colour White</p> <p>Required components: F15253_HEKLA-SOCKET-A</p>	
<p></p> <p>LED Vesta TW 9mm (12W) CSP</p> <p>FWHM / FWTM 24.1° / 46.3°</p> <p>Efficiency 82 %</p> <p>Peak intensity 3.6 cd/lm</p> <p>LEDs/each optic 1</p> <p>Light colour White</p> <p>Required components: C16142_HEKLA-SOCKET-K</p>	
<p>CITIZEN</p> <p>LED CLU700/701/702/703</p> <p>FWHM / FWTM 26.1 + 25.1° / 42.2°</p> <p>Efficiency 91 %</p> <p>Peak intensity 4.3 cd/lm</p> <p>LEDs/each optic 1</p> <p>Light colour White</p> <p>Required components: F15255_HEKLA-SOCKET-C</p>	

OPTICAL RESULTS (SIMULATED):

CITIZEN

LED CLU712/713
 FWHM / FWTM 24.0° / 46.0°
 Efficiency 90 %
 Peak intensity 4.2 cd/lm
 LEDs/each optic 1
 Light colour White
 Required components:
 F17438_HEKLA-G2-I

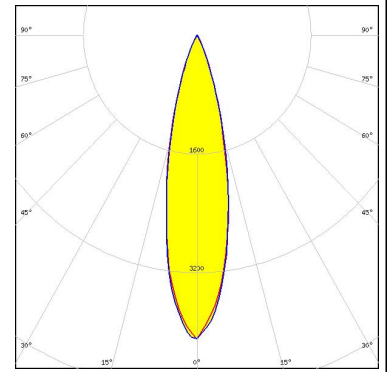

CREE LED

LED CMA1306
 FWHM / FWTM 24.0° / 43.0°
 Efficiency 91 %
 Peak intensity 4.5 cd/lm
 LEDs/each optic 1
 Light colour White
 Required components:
 F17439_HEKLA-G2-J

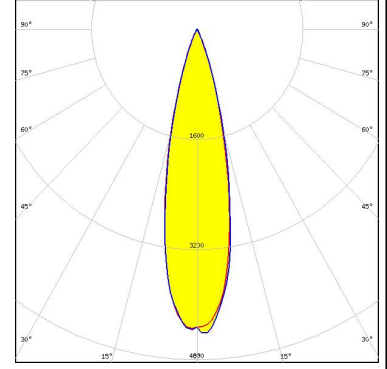

LUMILEDS

LED LUXEON CoB 1202/1203
 FWHM / FWTM 24.1° / 46.3°
 Efficiency 89 %
 Peak intensity 3.9 cd/lm
 LEDs/each optic 1
 Light colour White
 Required components:
 F15858_HEKLA-SOCKET-H

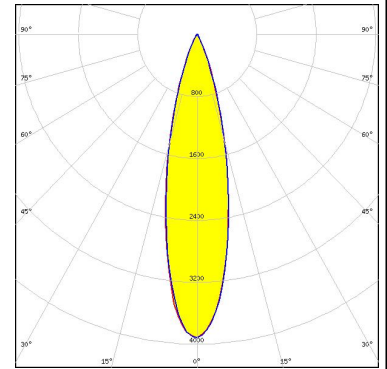

NICHIA

LED COB S-Type (LES 7)
 Assembly NULL
 FWHM / FWTM 25.0° / 44.0°
 Efficiency 89 %
 Peak intensity 4.2 cd/lm
 LEDs/each optic 1
 Light colour White
 Required components:
 Bender Wirth: 652a Hekla

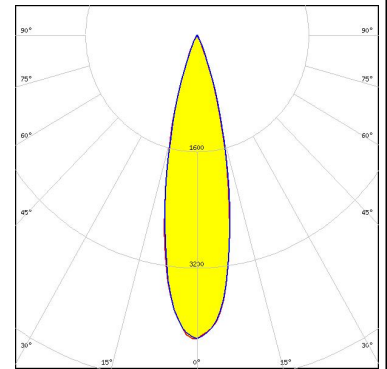

OPTICAL RESULTS (SIMULATED):

SAMSUNG

LED LC003D / LC006D / LC009D / LC013D
FWHM / FWTM 25.1° / 48.3°
Efficiency 87 %
Peak intensity 3.6 cd/lm
LEDs/each optic 1
Light colour White
Required components:
F15255_HEKLA-SOCKET-C

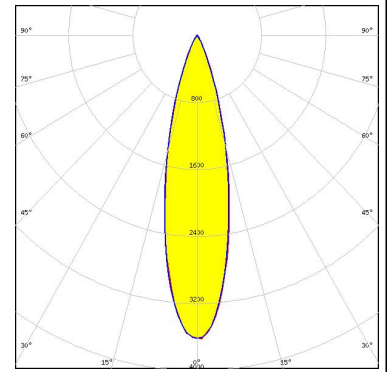

TRIDONIC

LED SLE SNC8 LES06
FWHM / FWTM 24.0° / 42.0 + 41.0°
Efficiency 93 %
Peak intensity 4.7 cd/lm
LEDs/each optic 1
Light colour White
Required components:
F17435_HEKLA-G2-C

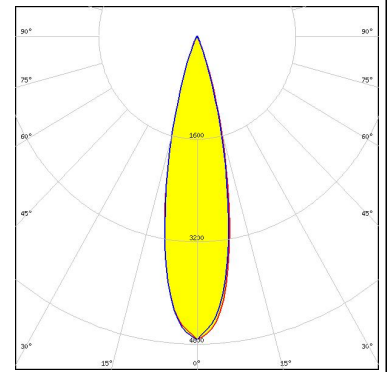

GENERAL INFORMATION:

NOTE: The typical beam angle will be changed by different color, chip size and chip position tolerance. The typical total beam angle is the full angle measured where the luminous intensity is half of the peak value.

Due to use of high power COB's with this product, special attention to proper thermal design is highly recommended. LEDiL has no liability for direct, indirect or consecutive damages arising from the LEDiL products being used outside of the recommended temperature range.

MATERIALS:

As part of our continuous research and improvement processes, and to ensure the best possible quality and availability of our products, LEDiL reserves the right to change material grades without notice.

PRODUCT DATA USER AGREEMENT AND DISCLAIMER:

The measured data in the provided downloadable LEDiL Product Datasheets and Mechanical 2D-Drawings is rounded and provided as reference for planning. LEDiL Oy's optical specifications have been verified by conducting performance testing of the products in accordance with the company's quality system. The reported data are averaged results of multiple measurements with typical variation. LEDiL Oy reserves the right to without prior notification make changes and improvements to its products.

LEDiL Oy assumes neither warranty, nor guarantee nor any other liability of any kind for the contents and correctness of the provided data. The provided data has been generated with highest diligence but the provided data may in reality not represent the complete possible variation range of all intrinsic parameters. Therefore, in certain cases a deviation from the provided data could occur.

LEDiL Oy reserves the right to undertake technical changes of its products without further notification which could lead to changes in the provided data. LEDiL Oy assumes no liability of any kind for the possible deviation from any provided data or any other damage resulting from the usage of the provided data.

The user agrees to this disclaimer and user agreement with the download or usage of the provided files.

LEDiL Oy

Joensuunkatu 13
FI-24240 SALO
Finland

LEDiL Inc.

228 West Page Street
Suite D
Sycamore IL 60178
USA

Ledil Optics Technology (Shenzhen) Co., Ltd.

405 , Block B
Casic Motor Building
Shenzhen 518057
P.R.CHINA

Local sales and technical support

[www.ledil.com/
where_to_buy](http://www.ledil.com/where_to_buy)

Shipping locations

Salo, Finland
Hong Kong, China

Distribution Partners

[www.ledil.com/
where_to_buy](http://www.ledil.com/where_to_buy)