

4-1658012-3 ✓ ACTIVE

## MICTOR

TE Internal #: 4-1658012-3

PCB Mount Receptacle, Vertical, Board-to-Board, 120 Position, .8mm [.031in] Centerline, Fully Shrouded, Select Gold, Printed Circuit Board

[View on TE.com >](#)



Connectors > PCB Connectors > Board-to-Board Connectors > Board-to-Board Headers & Receptacles



PCB Connector Assembly Type: **PCB Mount Receptacle**

PCB Mount Orientation: **Vertical**

Connector System: **Board-to-Board**

Number of Positions: **120**

Centerline (Pitch): **.8 mm [.031 in]**

## Features

### Product Type Features

PCB Connector Assembly Type	PCB Mount Receptacle
Connector System	Board-to-Board
Header Type	Fully Shrouded
Sealable	No
Connector & Contact Terminates To	Printed Circuit Board

### Configuration Features

Number of Rows	2
Stackable	No
Connector Contact Load Condition	Fully Loaded
PCB Mount Orientation	Vertical
Number of Positions	120
Board-to-Board Configuration	Parallel

### Electrical Characteristics

Dielectric Withstanding Voltage (Max)	675 VAC
Insulation Resistance	2 MΩ
Impedance	100 Ω
Operating Voltage	125 VAC

### Contact Features



PCB Contact Termination Area Plating Material Thickness	.25 µm[9.8425 µin]
Mating Tab Width	.38 mm[.015 in]
Mating Tab Thickness	.2 mm[.008 in]
Contact Shape & Form	Single Beam
PCB Contact Termination Area Plating Material	Gold
Contact Base Material	Phosphor Bronze
Contact Mating Area Plating Material	Select Gold
Contact Mating Area Plating Material Thickness	.25 µm[9.8425 µin]
Contact Type	Socket
Contact Current Rating (Max)	1.25 A, 9.5 A

### Termination Features

Rectangular Termination Post & Tail Thickness	.15 mm[.006 in]
Rectangular Termination Post & Tail Width	1.77 mm[.07 in]
Termination Method to Printed Circuit Board	Surface Mount

### Mechanical Attachment

PCB Mount Alignment Type	Locating Posts
Mating Retention	With
Mating Alignment	Without
PCB Mount Retention	With
PCB Mount Alignment	With
Connector Mounting Type	Board Mount

### Housing Features

Centerline (Pitch)	.8 mm[.031 in]
Housing Color	Black
Housing Material	LCP (Liquid Crystal Polymer)

### Dimensions

Connector Height	3.05 mm[.12 in]
Row-to-Row Spacing	3.47 mm[.136 in]
Stack Height	5 mm, 8 mm, 11 mm, 16 mm, 19 mm, 22 mm, 25 mm, 30 mm[1.181 in]
PCB Thickness (Recommended)	.06 mm[.25 in]

### Usage Conditions

Operating Temperature Range	-65 – 125 °C[-85 – 257 °F]
-----------------------------	----------------------------



**Operation/Application**

Assembly Process Feature	None
Circuit Application	Power & Signal

**Industry Standards**

UL Flammability Rating	UL 94V-0
------------------------	----------

**Packaging Features**

Packaging Quantity	475
Packaging Method	Pocket Tape

**Other**

Comment	Use of stand offs recommended. Contact Product Engineering for recommendations.
---------	---

**Product Compliance**

[For compliance documentation, visit the product page on TE.com>](#)







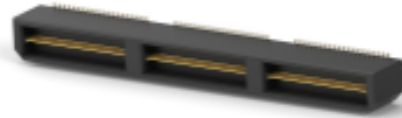

EU RoHS Directive 2011/65/EU	Not Yet Reviewed
EU ELV Directive 2000/53/EC	Compliant
China RoHS 2 Directive MIIT Order No 32, 2016	No Restricted Materials Above Threshold
EU REACH Regulation (EC) No. 1907/2006	Current ECHA Candidate List: JAN 2021 (211) Candidate List Declared Against: JUN 2012 (84) SVHC > Threshold: Not Yet Reviewed
Halogen Content	Low Halogen - Br, Cl, F, I < 900 ppm per homogenous material. Also BFR/CFR/PVC Free
Solder Process Capability	Reflow solder capable to 260°C

Product Compliance Disclaimer

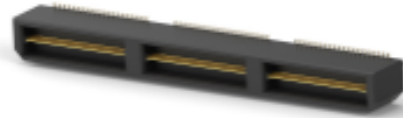
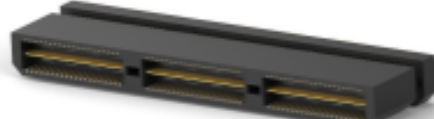
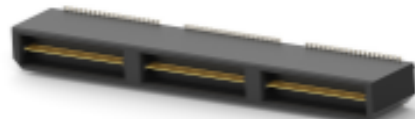
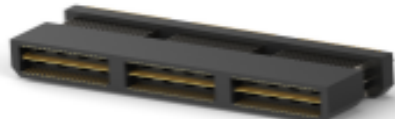
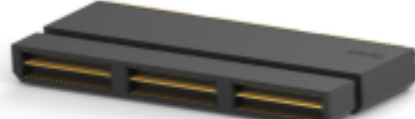
This information is provided based on reasonable inquiry of our suppliers and represents our current actual knowledge based on the information they provided. This information is subject to change. The part numbers that TE has identified as EU RoHS compliant have a maximum concentration of 0.1% by weight in homogenous materials for lead, hexavalent chromium, mercury, PBB, PBDE, DBP, BBP, DEHP, DIBP, and 0.01% for cadmium, or qualify for an exemption to these limits as defined in the Annexes of Directive 2011/65/EU (RoHS2). Finished electrical and electronic equipment products will be CE marked as required by Directive 2011/65/EU. Components may not be CE marked. Additionally, the part numbers that TE has identified as EU ELV compliant have a maximum concentration of 0.1% by weight in homogenous materials for lead, hexavalent chromium, and mercury, and 0.01% for cadmium, or qualify for an exemption to these limits as defined in the Annexes of Directive 2000/53/EC (ELV). Regarding the REACH Regulations, TE's information on SVHC in articles for this part number is still based on the European Chemical Agency (ECHA) 'Guidance on requirements for substances in articles' (Version: 2, April 2011), applying the 0.1% weight on weight concentration threshold at the finished product level. TE is aware of the European Court of Justice ruling of September 10th, 2015 also known as O5A (Once An Article Always An Article) stating that, in case of 'complex object', the threshold for a SVHC must be applied to both the

product as a whole and simultaneously to each of the articles forming part of its composition. TE has evaluated this ruling based on the new ECHA "Guidance on requirements for substances in articles" (June 2017, version 4.0) and will be updating its statements accordingly.

## Compatible Parts

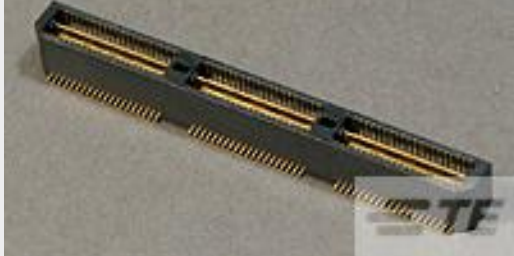
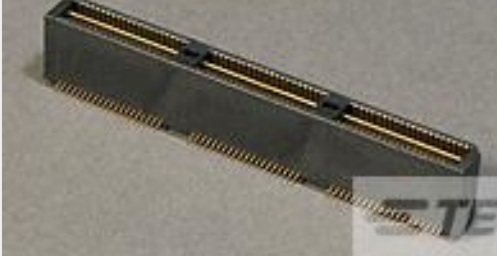
 <p>TE Part # 1658014-3 MSB0.80PL8ASY120FL,-,10,-TY</p>	 <p>TE Part # 1658013-3 MSB0.80PL5ASY120FL,-,10,-TY</p>	 <p>TE Part # 1658016-3 MSB0.80PL16ASY120FL,-,10,-TY</p>	 <p>TE Part # 2-1658014-3 MSB0.80PL8ASY120FL,-,10,-TY</p>
 <p>TE Part # 6-1658016-3 MSB0.80PL16ASY120FL,GP,10,-TR</p>	 <p>TE Part # 1658015-3 MSB0.80PL11ASY120FL,-,10,-TY</p>	 <p>TE Part # 1658017-3 MSB0.80PL19ASY120FL,-,10,-TY</p>	 <p>TE Part # 1658019-3 MSB0.80PL25ASY120FL,-,10,-TY</p>
 <p>TE Part # 2-1658016-3 MSB0.80PL16ASY120FL,-,10,-TY</p>	 <p>TE Part # 2-1658018-3 MSB0.80PL22ASY120FL,-,10,-TY</p>	 <p>TE Part # 2-1658013-3 MSB0.80PL5ASY120FL,-,10,-TY</p>	 <p>TE Part # 1658018-3 MSB0.80PL22ASY120FL,-,10,-TY</p>
 <p>TE Part # 1658020-3 MSB0.80PL30ASY120FL,-,10,-TY</p>	 <p>TE Part # 1658044-3 MSB0.80PL5ASY120FL,-,F,-TY</p>	 <p>TE Part # 1658045-3 MSB0.80PL8ASY120FL,-,F,-TY</p>	 <p>TE Part # 1658046-3 MSB0.80PL11ASY120FL,-,F,-TY</p>



TE Part # 1658047-3  
MSB0.80PL16ASY120FL,-,F,-TY

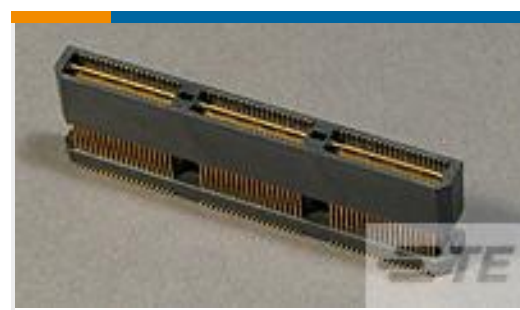

TE Part # 1658048-3  
MSB0.80PL19ASY120FL,-,F,-TY



TE Part # 1658049-3  
MSB0.80PL22ASY120FL,-,F,-TY



TE Part # 1658050-3  
MSB0.80PL25ASY120FL,-,F,-TY

## Customers Also Bought

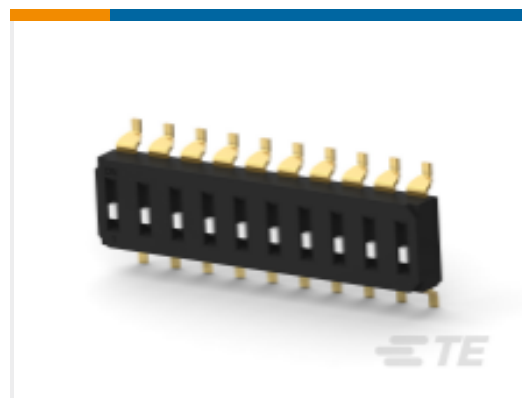

TE Part #3-2319848-1  
END STACK DIP 10P G RECESS SEAL  
TUBE



TE Part #2331390-1  
DET SW5.7X4.0X2.0 GW HORZ. NC  
AG RL

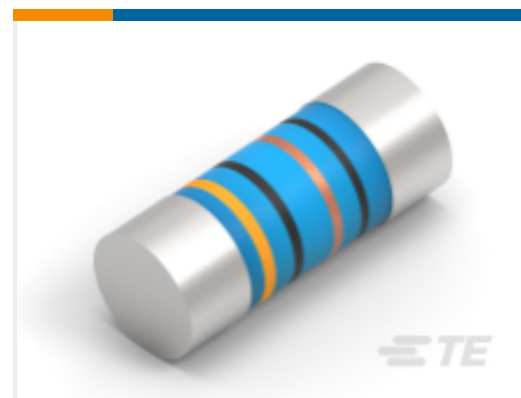

TE Part #2176314-4  
MELF SMA\_A 180R 0.1% 15PPM 0102  
0.3W



TE Part #5146893-2  
Free Height Receptacle Conn: Board-  
Board, Vertical, 84, 1mm

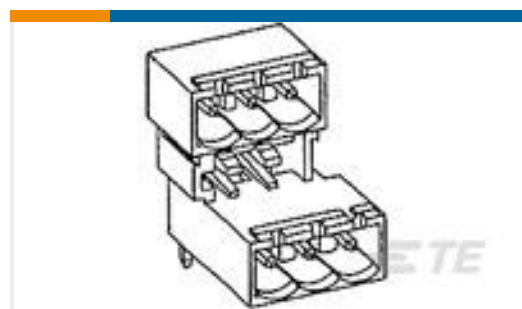

TE Part #284061-5  
TERMI-BLOK HDR 90, 5,08MM P. M



TE Part #1761072-3  
RECPT,HSSDC2,FIBRE,TRAY PKG



TE Part #1-1825006-9  
GDS10S04=DIP SW,SLIDE,SMT



TE Part #1-928836-2  
MOD2 PIN WITH A-PIN L/P



TE Part #3-1415020-1  
PT570N20



TE Part #4-1624112-0  
3650 0402 9.0nH 5% 2K RL

## Documents

### Product Drawings

[MSB0.80RC-ASY120FL,GP,10,-TR](#)

English

### CAD Files

[3D PDF](#)

[3D](#)

[Customer View Model](#)

[ENG\\_CVM\\_CVM\\_4-1658012-3\\_P.2d\\_dxf.zip](#)



English

**Customer View Model**

[ENG\\_CVM\\_CVM\\_4-1658012-3\\_P.3d\\_igs.zip](#)

English

**Customer View Model**

[ENG\\_CVM\\_CVM\\_4-1658012-3\\_P.3d\\_stp.zip](#)

English

By downloading the CAD file I accept and agree to the [Terms and Conditions](#) of use.

---

## Datasheets & Catalog Pages

[MICTOR SB Interconnection System](#)

English

---

## Product Specifications

[Application Specification](#)

English