



## BUL216

# HIGH VOLTAGE FAST-SWITCHING NPN POWER TRANSISTOR

- STMicroelectronics PREFERRED SALESTYPE
- NPN TRANSISTOR
- HIGH VOLTAGE CAPABILITY
- VERY HIGH SWITCHING SPEED
- HIGH OPERATING JUNCTION TEMPERATURE
- HIGH RUGGEDNESS

### APPLICATIONS

- ELECTRONIC BALLASTS FOR FLUORESCENT LIGHTING
- SWITCH MODE POWER SUPPLIES

### DESCRIPTION

The BUL216 is manufactured using high voltage Multi-epitaxial Mesa technology for cost-effective high performance. It uses a Hollow Emitter structure to enhance switching speeds.

The BUL series is designed for use in lighting applications and low cost switch-mode power supplies.

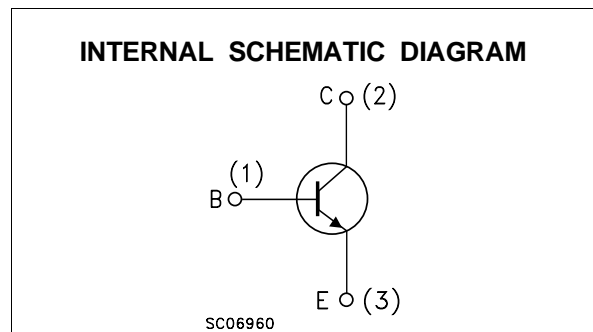
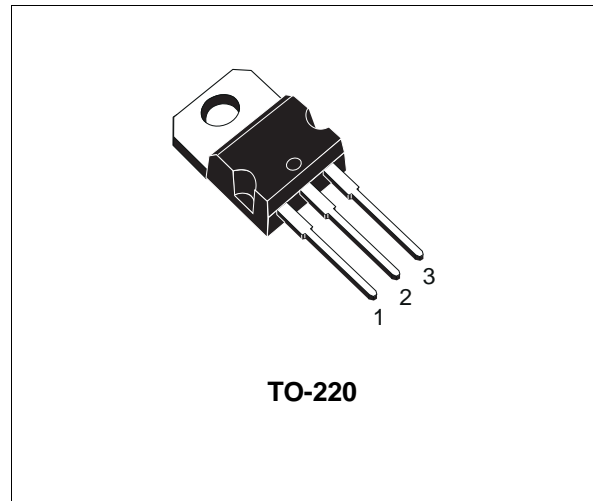

### ABSOLUTE MAXIMUM RATINGS

Symbol	Parameter	Value	Unit
$V_{CES}$	Collector-Emitter Voltage ( $V_{BE} = 0$ )	1600	V
$V_{CEO}$	Collector-Emitter Voltage ( $I_B = 0$ )	800	V
$V_{EBO}$	Emitter-Base Voltage ( $I_C = 0$ )	9	V
$I_C$	Collector Current	4	A
$I_{CM}$	Collector Peak Current ( $t_p < 5$ ms)	6	A
$I_B$	Base Current	2	A
$I_{BM}$	Base Peak Current ( $t_p < 5$ ms)	4	A
$P_{tot}$	Total Dissipation at $T_c = 25$ °C	90	W
$T_{stg}$	Storage Temperature	-65 to 150	°C
$T_j$	Max. Operating Junction Temperature	150	°C

**THERMAL DATA**

R <sub>thj-case</sub>	Thermal Resistance Junction-Case	Max	1.39	°C/W
R <sub>thj-amb</sub>	Thermal Resistance Junction-Ambient	Max	62.5	°C/W

**ELECTRICAL CHARACTERISTICS** (T<sub>case</sub> = 25 °C unless otherwise specified)

Symbol	Parameter	Test Conditions	Min.	Typ.	Max.	Unit
I <sub>CES</sub>	Collector Cut-off Current (V <sub>BE</sub> = 0)	V <sub>CE</sub> = 1600 V V <sub>CE</sub> = 1600 V T <sub>j</sub> = 125 °C			100 500	μA μA
I <sub>CEO</sub>	Collector Cut-off Current (I <sub>B</sub> = 0)	V <sub>CE</sub> = 800 V			250	μA
V <sub>CEO(sus)</sub>	Collector-Emitter Sustaining Voltage	I <sub>C</sub> = 100 mA L = 25 mH	800			V
V <sub>EBO</sub>	Emitter-Base Voltage (I <sub>C</sub> = 0)	I <sub>E</sub> = 10 mA	9			V
V <sub>CE(sat)*</sub>	Collector-Emitter Saturation Voltage	I <sub>C</sub> = 1 A I <sub>B</sub> = 0.2 A I <sub>C</sub> = 2 A I <sub>B</sub> = 0.66 A			1 3	V V
V <sub>BE(sat)*</sub>	Base-Emitter Saturation Voltage	I <sub>C</sub> = 1 A I <sub>B</sub> = 0.2 A I <sub>C</sub> = 2 A I <sub>B</sub> = 0.66 A			1.2 1.2	V V
h <sub>FE*</sub>	DC Current Gain	I <sub>C</sub> = 0.4 A V <sub>CE</sub> = 5 V I <sub>C</sub> = 10 mA V <sub>CE</sub> = 5 V	12 10		40	
t <sub>s</sub> t <sub>f</sub>	INDUCTIVE LOAD Storage Time Fall Time	I <sub>C</sub> = 1.5 A I <sub>B1</sub> = 0.5 A V <sub>BE(off)</sub> = -5 V R <sub>BB</sub> = 0 Ω V <sub>CL</sub> = 250 V L = 200 μH		2.1 450	3.3 720	μs ns
t <sub>s</sub> t <sub>f</sub>	INDUCTIVE LOAD Storage Time Fall Time	I <sub>C</sub> = 1.5 A I <sub>B1</sub> = 0.5 A V <sub>BE(off)</sub> = -5 V R <sub>BB</sub> = 0 Ω V <sub>CL</sub> = 250 V L = 200 μH T <sub>j</sub> = 100 °C		3 600		μs ns

\* Pulsed: Pulse duration = 300 μs, duty cycle 1.5 %

**Safe Operating Areas**

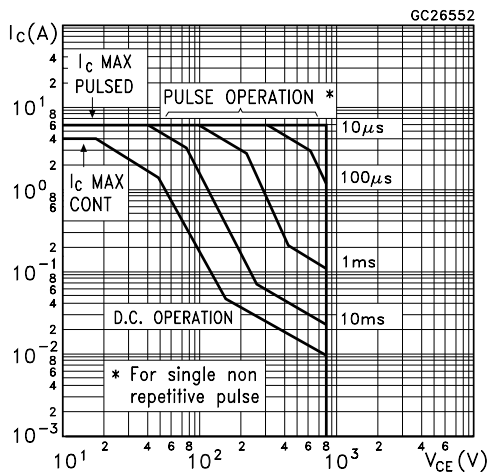

**Derating Curve**

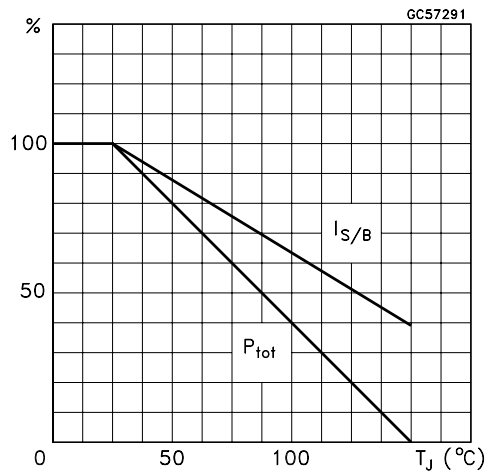

DC Current Gain

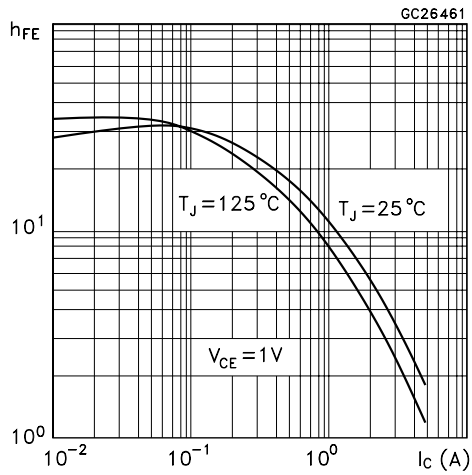

DC Current Gain

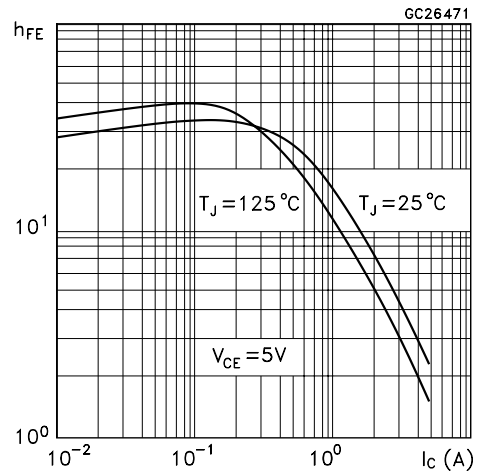

Collector Emitter Saturation Voltage

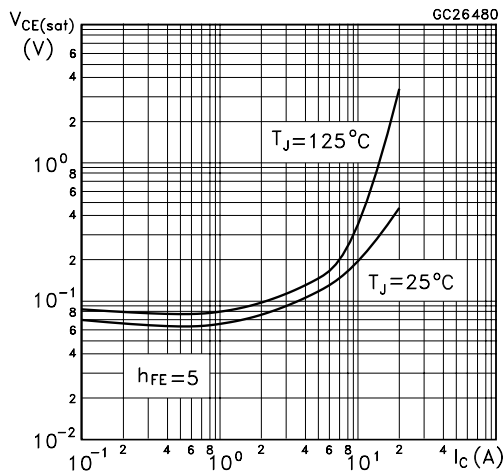

Base Emitter Saturation Voltage

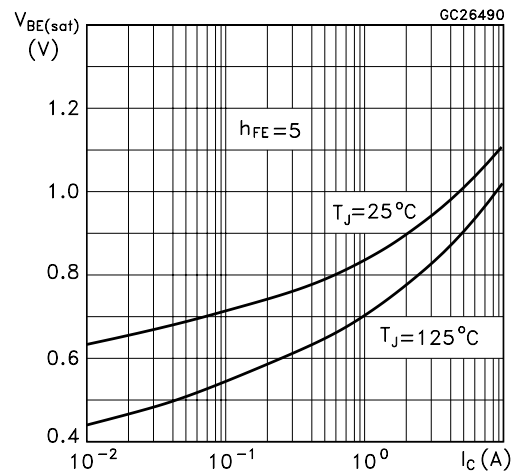

Inductive Fall Time

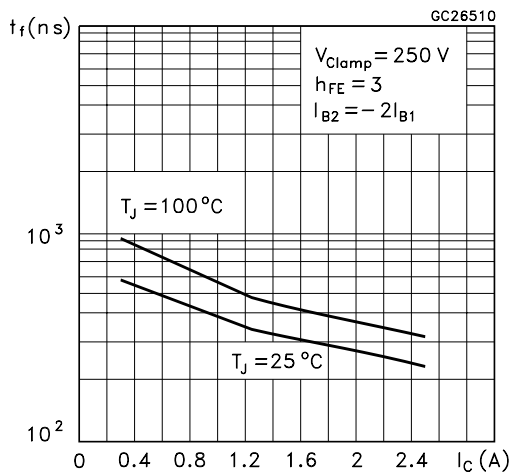

Inductive Storage Time

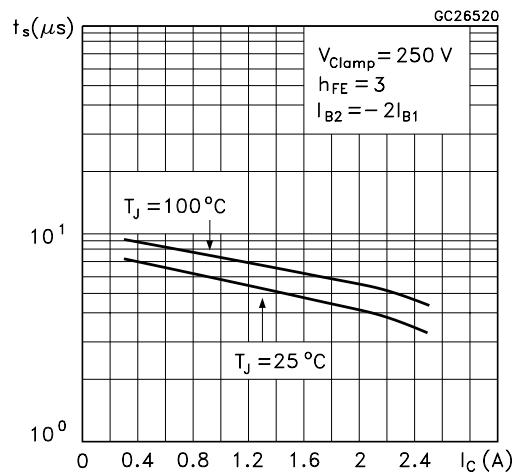

Inductive Fall Time

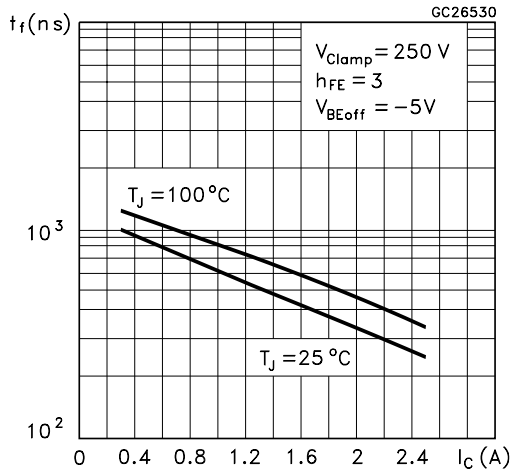

Inductive Storage Time

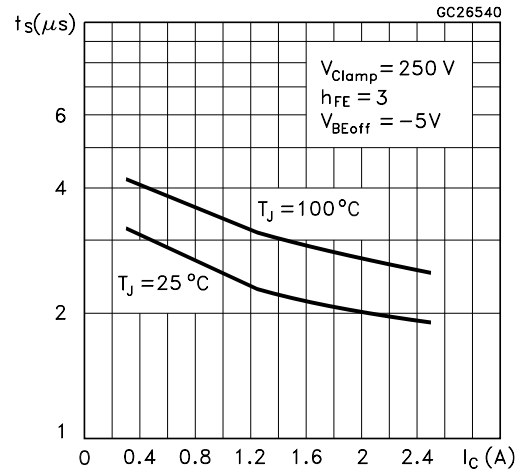

Reverse Biased SOA

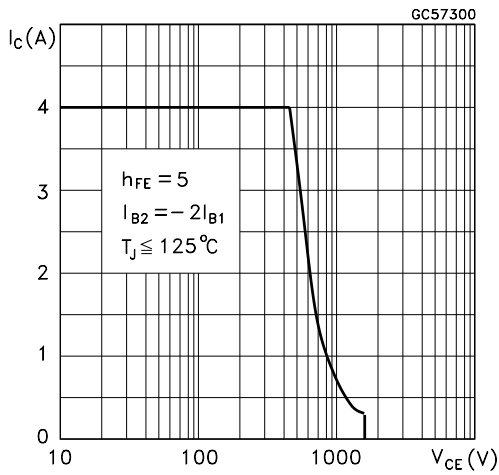

RBSOA and Inductive Load Switching Test Circuits

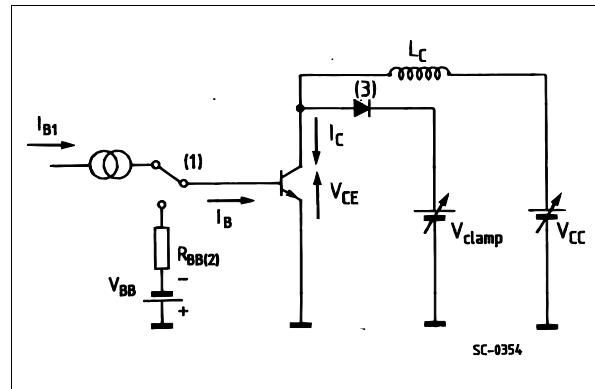

- (1) Fast electronic switch
- (2) Non-inductive Resistor
- (3) Fast recovery rectifier

**TO-220 MECHANICAL DATA**

DIM.	mm			inch		
	MIN.	TYP.	MAX.	MIN.	TYP.	MAX.
A	4.40		4.60	0.173		0.181
C	1.23		1.32	0.048		0.052
D	2.40		2.72	0.094		0.107
E	0.49		0.70	0.019		0.027
F	0.61		0.88	0.024		0.034
F1	1.14		1.70	0.044		0.067
F2	1.14		1.70	0.044		0.067
G	4.95		5.15	0.194		0.202
G1	2.40		2.70	0.094		0.106
H2	10.00		10.40	0.394		0.409
L2		16.40			0.645	
L4	13.00		14.00	0.511		0.551
L5	2.65		2.95	0.104		0.116
L6	15.25		15.75	0.600		0.620
L7	6.20		6.60	0.244		0.260
L9	3.50		3.93	0.137		0.154
M		2.60			0.102	
DIA.	3.75		3.85	0.147		0.151



Information furnished is believed to be accurate and reliable. However, STMicroelectronics assumes no responsibility for the consequences of use of such information nor for any infringement of patents or other rights of third parties which may result from its use. No license is granted by implication or otherwise under any patent or patent rights of STMicroelectronics. Specification mentioned in this publication are subject to change without notice. This publication supersedes and replaces all information previously supplied. STMicroelectronics products are not authorized for use as critical components in life support devices or systems without express written approval of STMicroelectronics.

The ST logo is a trademark of STMicroelectronics

© 2001 STMicroelectronics – Printed in Italy – All Rights Reserved

STMicroelectronics GROUP OF COMPANIES

Australia - Brazil - China - Finland - France - Germany - Hong Kong - India - Italy - Japan - Malaysia - Malta - Morocco - Singapore - Spain - Sweden - Switzerland - United Kingdom - U.S.A.

<http://www.st.com>