

General-purpose power entry module FN 9260

- up to 10A current ratings
 - IEC 950-compliant
 - for one or two fuses (Ø5 x 20mm)
 - optional medical version (B type)
-
- Nennstrom bis 10A
 - IEC 950 konform
 - Für eine oder zwei Sicherungen (Ø5 x 20mm)
 - Für medizinische Geräte als Option (Typ B)
-
- courants de service pouvant atteindre 10A
 - conforme à CEI 950
 - pour un ou deux fusibles (Ø5 x 20mm)
 - version médicale en option (type B)



Filter selection table

Choose the family FN xxx with the required body style and features, and add -?? to determine current rating, and /?? for output connections. Example: FN 9260-1/06 is a horizontal screw-mounting filter for twin fuses, rated for 1A, with fast-on outputs.

Approvals



Family	Current ratings A at 40°C (25°)					Output connection	Housing		For fuse(s) Nbr.
	1 (1.2)	2 (2.3)	4 (4.6)	6 (6.9)	10 (11.5)				
FN 261 -?? /??	-1	-2	-4	-6	-10	/06	✓	-	1
FN 261S -?? /??	-1	-2	-4	-6	-10	/06	-	✓	1
FN 9260 -?? /??	-1	-2	-4	-6	-10	/06	✓	-	2
FN 9260S -?? /??	-1	-2	-4	-6	-10	/06	-	✓	2
Inductance L mH									
	5.3	2.7	1	0.3	0.2				

Additional specifications

Filter type	Capacitance		Maximum leakage µA/phase	Res. R MΩ	Weight g	Maximum operating volt.		Operating frequency Hz	Hipot test voltage	
	Cx nF	Cy nF				VAC	Hz		PN→E VAC	P→N VDC
All standard types	100	2.2	190	1	50	250	50/60	DC to 400	2000	1700
FN 9260B types (medical)	100	-	2	1	50	250	50/60	DC to 400	2500	1700

MTBF at 40°C, 230V, per Mil-HB-217F: 2,200,000 hours

Electrical schematics

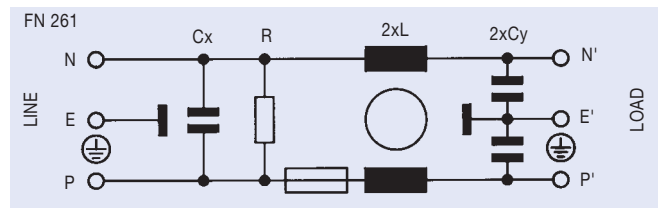
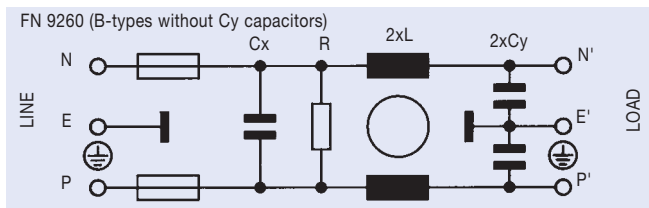

See tables for component values

FN 9260 insertion loss

Per CISPR 17; A = 50Ω/50Ω sym, B = 50Ω/50Ω asym, C = 0.1Ω/100Ω sym, D = 100Ω/0.1Ω sym

1 amp FN 261 types

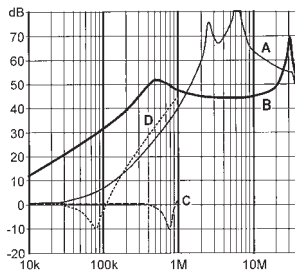

2 amp FN 261 types

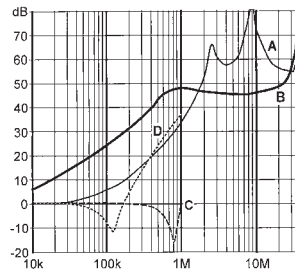

4 amp FN 261 types

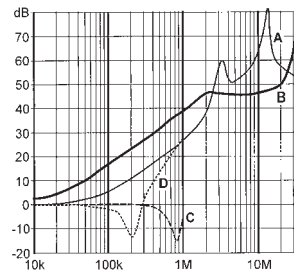

6/10 amp FN 261 types

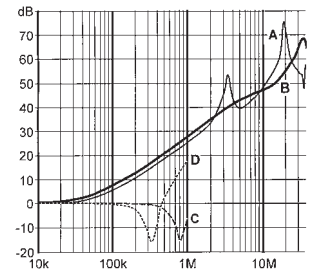

1 amp FN 9260 types

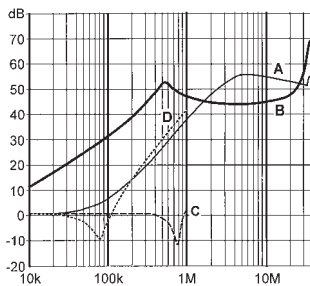

2 amp FN 9260 types

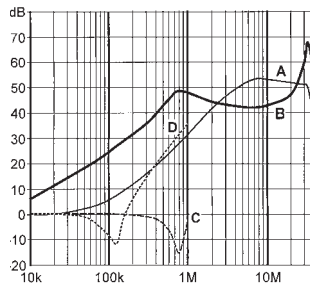

4 amp FN 9260 types

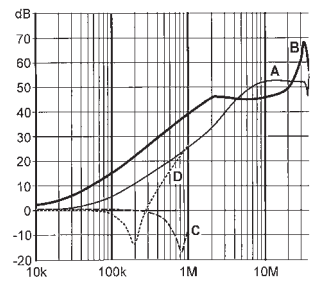

6/10 amp FN 9260 types

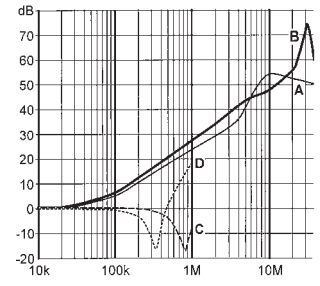

Mechanical data

	FN 261 FN 9260	FN 261S FN 9260S	Tol. mm
A	46	34	± 0.3
B		35	± 0.3
C	36		± 0.2
D		41	± 0.3
E		27.9	+0.2 -0
F	5.5		± 0.3
G		32.2	+0 -0.2
H	∅3.3		± 0.1
J		12.5	± 0.3
M	R≤3.5		-
N	33.2	29.5	± 0.1
P	29.2	33.0	± 0.1
R	M3		-
S	90°		-
T		panel thickness 0.6-3.5mm	-

FN 261/FN 9260

FRONT

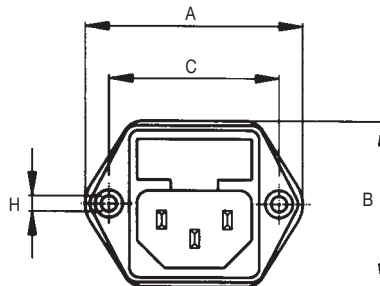

PANEL CUT-OUT

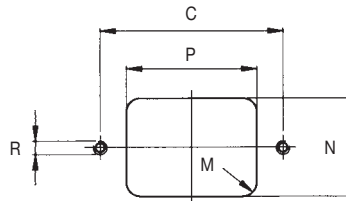

TOP

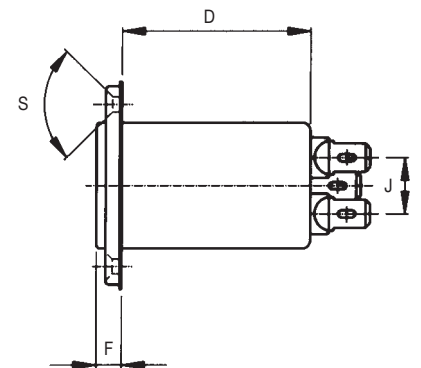

FN 261S/FN 9260S

REAR

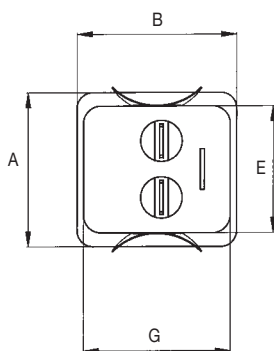

TOP

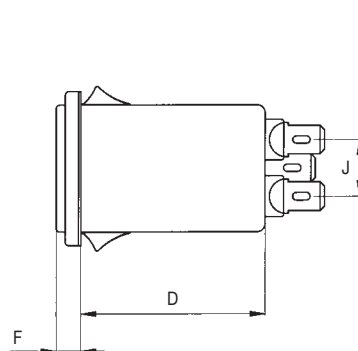

FRONT

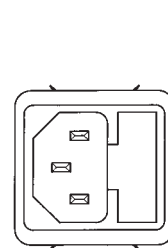

PANEL CUT-OUT

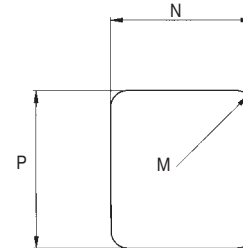

All dimensions in mm; 1 inch = 25.4mm