

Pressure Filter MDF up to 280 l/min, up to 280 bar

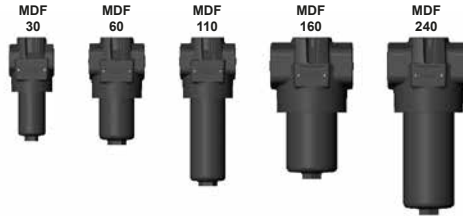

1. TECHNICAL SPECIFICATIONS

1.1 FILTER HOUSING

Construction

The filter housings are designed in accordance with international regulations. They consist of a filter head and a screw-in filter bowl.

Standard equipment:

- connection for a clogging indicator in filter head
- without bypass valve
- installation holes in the filter head

1.2 FILTER ELEMENTS

HYDAC filter elements are validated and their quality is constantly monitored according to the following standards:

- ISO 2941
- ISO 2942
- ISO 2943
- ISO 3724
- ISO 3968
- ISO 11170
- ISO 16889

Contamination retention capacities in g

MDF	Betamicon® (BN4HC)			
	3 µm	5 µm	10 µm	20 µm
30	4.6	5.1	5.4	5.6
60	6.5	7.3	7.8	8.0
110	13.8	15.5	16.4	16.9
160	19.8	22.2	23.5	24.3
240	32.3	36.3	38.4	39.6

MDF	Betamicon® (BH4HC)			
	3 µm	5 µm	10 µm	20 µm
30	3	2.9	3.2	3.7
60	4.6	4.5	5	5.7
110	10.1	9.9	10.9	12.4
160	12.9	12.6	13.9	15.9
240	21.6	21.1	23.2	26.5

Filter elements are available with the following pressure stability values:

Betamicon® (BN4HC):	20 bar
Betamicon® (BH4HC):	210 bar
Wire mesh (W):	20 bar
Stainless steel fibre (V):	210 bar

1.3 FILTER SPECIFICATIONS

Nominal pressure	210 bar or 280 bar
Fatigue strength	min. 5 million cycles at 1.2 times nominal pressure (for other pressures, see Point 1.8)
Temperature range	-30 °C to +100 °C (-30 °C to -10 °C: p _{max} = 140 bar)
Material of filter head	EN-GJS-400-15
Material of filter bowl	Steel
Type of indicator	VM (Diff. pressure indicator up to 210 bar operating pressure) VD (Diff. pressure indicator up to 420 bar operating pressure)
Pressure setting of the clogging indicator	5 bar (others on request)
Bypass cracking pressure (optional)	6 bar (others on request)

1.4 SEALS

NBR (=Perbunan)

1.5 INSTALLATION

Inline filter

1.6 SPECIAL MODELS AND ACCESSORIES

- Bypass valve built into the head, separate from the main flow
- Oil drain plug
- Seals in FPM, EPDM
- Test and approval certificates

1.7 SPARE PARTS

See Original Spare Parts List

1.8 FATIGUE STRENGTH

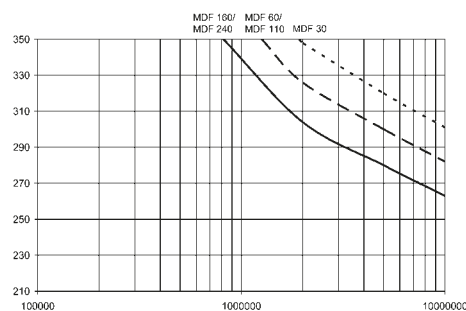

1.9 CERTIFICATES AND APPROVALS

- Test certificate 2.2
- Manufacturer's certificate O and M to DIN 55350, part 18
- Other certificates on request

1.10 COMPATIBILITY WITH HYDRAULIC FLUIDS ISO 2943

- Hydraulic oils H to HLPD DIN 51524
- Lubrication oils DIN 51517, API, ACEA, DIN 51515, ISO 6743
- Compressor oils DIN 51506
- Biodegradable operating fluids VDMA 24568 HETG, HEES, HEPG
- Fire-resistant fluids HFA, HFB, HFC and HFD
- Operating fluids with high water content (> 50 % water content) on request

1.11 IMPORTANT INFORMATION

- Filter housings must be earthed.
- When using electrical clogging indicators, the electrical power supply to the system must be switched off before removing the clogging indicator connector.

Symbol for hydraulic systems

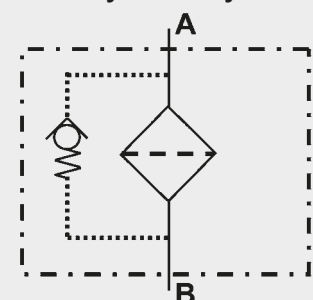

2. MODEL CODE (also order example)

MDF BN/HC 60 O C 10 D 1 . X /-L24

2.1 COMPLETE FILTER

Filter type

MDF

Filter material of element

BN/HC Betamicon® (BN4HC) W Stainl. steel wire mesh
 BH/HC Betamicon® (BH4HC) V Stainless steel fibre

Size of filter or element

MDF: 30, 60, 110, 160, 240

Operating pressure

Threaded port: L = 210 bar (VM clogging indicator)
 O = 280 bar (standard; VD clogging indicator)
 Flange connection: L = 210 bar (3000 PSI flange) → VM clogging indicator

Type and size of connection

Type	Connection	Filter size				
		30	60	110	160	240
B	G 1/2	●				
C	G 3/4	●	●	●		
D	G1		●	●		
E	G1 1/4				●	●
F	G1 1/2				●	●
H	SAE DN 13	●				
I	SAE DN 20		●	●		
J	SAE DN 32				●	●

■ Preferred models

Filtration rating in µm

BN/HC, BH/HC, V: 3, 5, 10, 20
 W: 25, 50, 100, 200

Type of clogging indicator

Y plastic blanking plug in indicator port
 A stainless steel blanking plug in indicator port
 B visual
 C electrical
 D visual and electrical
 for other clogging indicators, see brochure no. 7.050../..

Type code

1

Modification number

X the latest version is always supplied

Supplementary details

B. bypass cracking pressure (e.g. B6 = 6 bar); without details = without bypass valve
 L... light with appropriate voltage (24V, 48V, 110V, 220V) only for clogging indicators type "D"
 LED 2 light emitting diodes up to 24 Volt
 SO184 pressure release/oil drain screw
 V FPM seals
 W suitable for HFA, HFC oil-water emulsions (only necessary when using a clogging indicator or V or W elements)

2.2 REPLACEMENT ELEMENT

0060 D 010 BN4HC /-V

Size

0030, 0060, 0110, 0160, 0240

Type

D

Filtration rating in µm

BN4HC, BH4HC, V: 003, 005, 010, 020
 W: 025, 050, 100, 200

Filter material

BN4HC, BH4HC, V, W

Supplementary details

V, W (for descriptions, see point 2.1)

2.3 REPLACEMENT CLOGGING INDICATOR

VM 5 D . X /-L24

Type of indicator

VM Diff. pressure indicator up to 210 bar oper. pressure
 VD Diff. pressure indicator 420 bar oper. pressure

Pressure setting

5 standard 5 bar, others on request

Type of clogging indicator

D (see Point 2.1)

Modification number

X the latest version is always supplied

Supplementary details

L..., LED, V, W (for descriptions, see point 2.1)

3. FILTER CALCULATION / SIZING

The total pressure drop of a filter at a certain flow rate Q is the sum of the housing Δp and the element Δp and is calculated as follows:

$$\Delta p_{\text{total}} = \Delta p_{\text{housing}} + \Delta p_{\text{element}}$$

$$\Delta p_{\text{housing}} = (\text{see Point 3.1})$$

$$\Delta p_{\text{element}} = Q \cdot \frac{SK^*}{1000} \cdot \frac{\text{viscosity}}{30}$$

(*see point 3.2)

For ease of calculation, our Filter Sizing Program is available on request free of charge.

NEW: Sizing online at www.hydac.com

3.1 Δp -Q HOUSING CURVES BASED ON ISO 3968

The housing curves apply to mineral oil with a density of 0.86 kg/dm³ and a kinematic viscosity of 30 mm²/s. In this case, the differential pressure changes proportionally to the density.

MDF 30

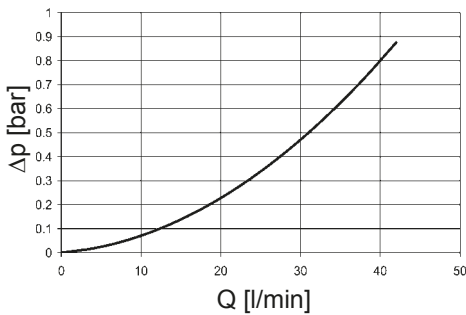

MDF 60-110

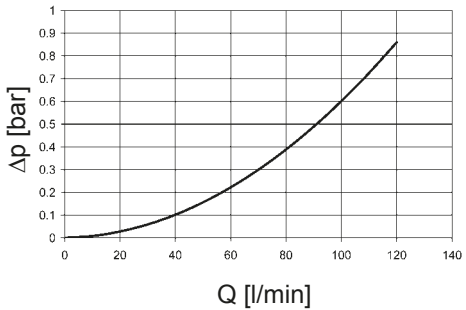

MDF 160-240

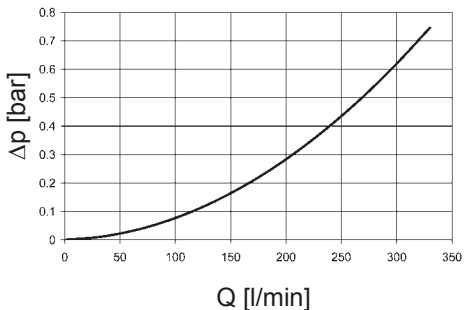

3.2 GRADIENT COEFFICIENTS (SK) FOR FILTER ELEMENTS

The gradient coefficients in mbar/(l/min) apply to mineral oils with a kinematic viscosity of 30 mm²/s. The pressure drop changes proportionally to the change in viscosity.

MDF	V				W	BH4HC			
	3 μm	5 μm	10 μm	20 μm		3 μm	5 μm	10 μm	20 μm
30	18.4	13.5	7.5	3.6	3.030	91.2	50.7	36.3	19.0
60	16.0	9.3	5.4	3.3	0.757	58.6	32.6	18.1	12.2
110	8.2	5.6	3.3	2.2	0.413	25.4	14.9	8.9	5.6
160	4.6	3.2	2.3	1.4	0.284	16.8	10.4	5.9	4.4
240	3.1	2.5	1.7	1.1	0.189	10.6	6.8	3.9	2.9

BN4HC: MDF 30

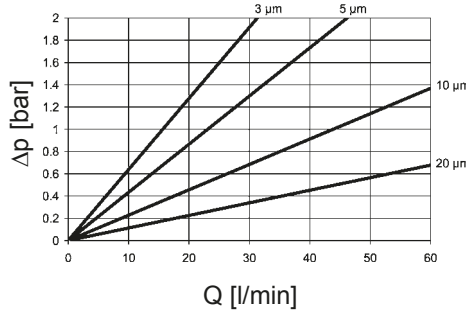

BN4HC: MDF 60

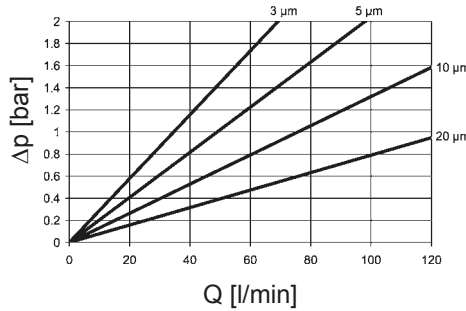

BN4HC: MDF 110

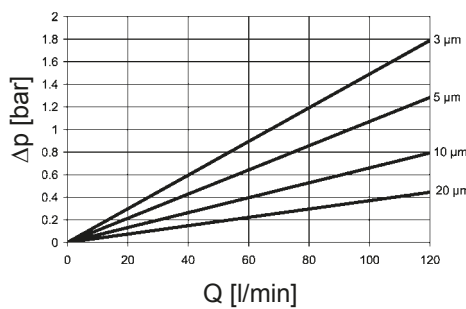

BN4HC: MDF 160

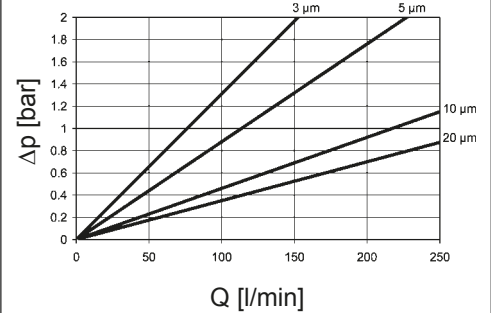

BN4HC: MDF 240

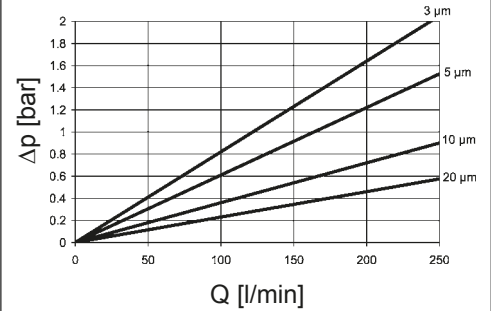

4. DIMENSIONS

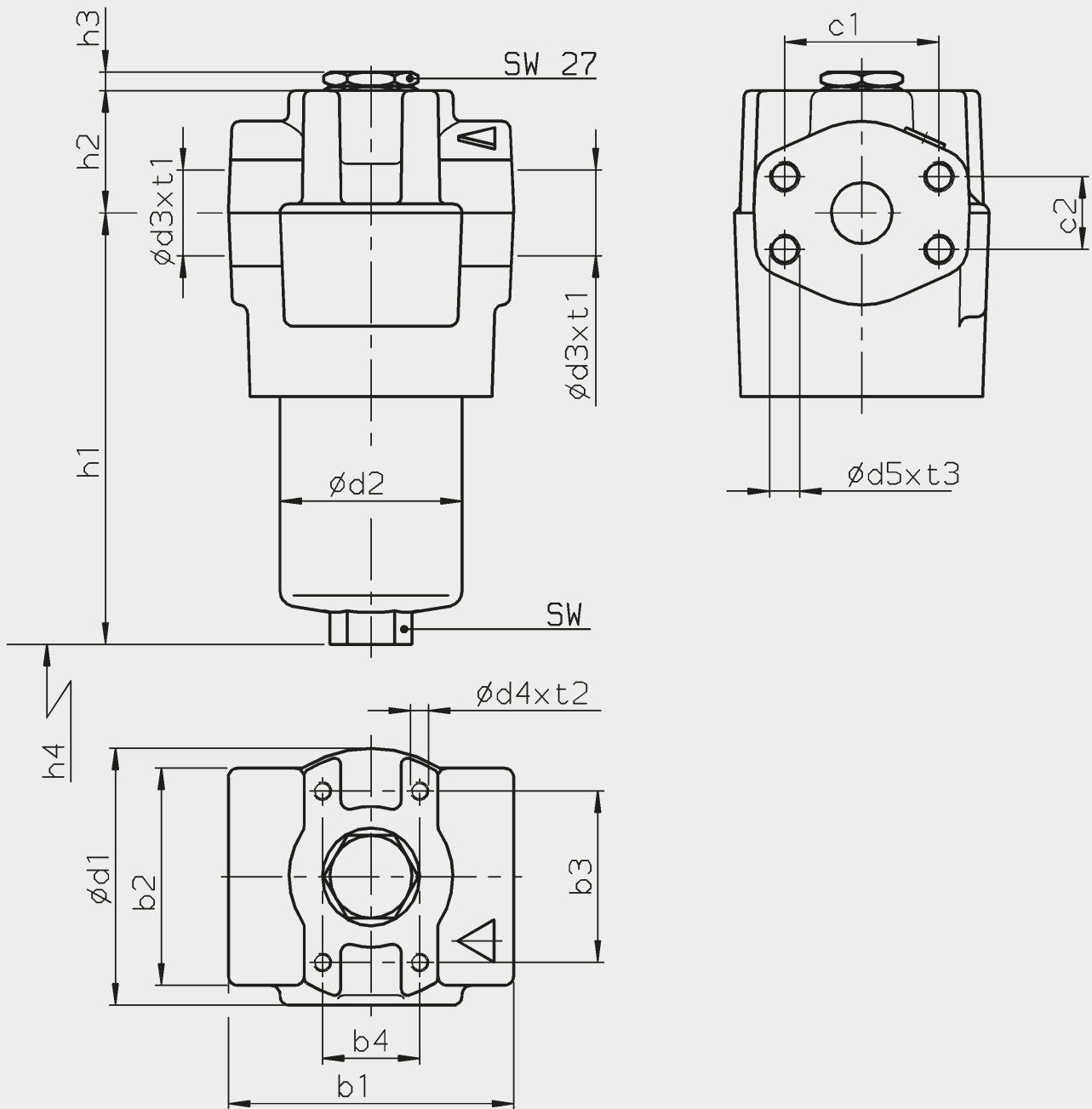

MDF	b1	b2	b3	b4	c1	c2	d1	d2	d3	d4	d5	h1	h2	h3	h4	SW	t1	t2	t3	Weight incl. element [kg]	Volume of pressure chamber [l]
30 (B/C)	71	55	45	30	-	-	69	45	G $\frac{1}{2}$ - G $\frac{3}{4}$	M5	-	133	38	6	75	19	14 - 17	6	-	2.3	0.1
30 (H)	70	55	45	30	38.1	17.5	69	45	SAE DN 13	M5	M8	133	38	6	75	19	-	6	12	2.3	0.1
60 (C/D)	90	71	56	32	-	-	86	59	G $\frac{3}{4}$ - G1	M6	-	138	40	6	85	27	17 - 19	9	-	4.1	0.18
60 (I)	89	71	56	32	47.6	22.2	86	59	SAE DN 20	M6	M10	138	40	6	85	27	-	9	15	4.1	0.18
110 (C/D)	90	71	56	32	-	-	86	59	G $\frac{3}{4}$ - G1	M6	-	206	40	6	85	27	17 - 19	9	-	4.6	0.32
110 (I)	89	71	56	32	47.6	22.2	86	59	SAE DN 20	M6	M10	206	40	6	85	27	-	9	15	4.6	0.32
160 (E/F)	133	95	85	35	-	-	119	84	G1 $\frac{1}{4}$ - G1 $\frac{1}{2}$	M10	-	187	47	6	105	32	21 - 23	14	-	9.6	0.55
160 (J)	133	95	85	35	58.7	30.2	119	84	SAE DN 32	M10	M10	187	47	6	105	32	-	14	15	9.6	0.55
240 (E/F)	133	95	85	35	-	-	119	84	G1 $\frac{1}{4}$ - G1 $\frac{1}{2}$	M10	-	246	47	6	105	32	21 - 23	14	-	10.5	0.79
240 (J)	133	95	85	35	58.7	30.2	119	84	SAE DN 32	M10	M10	246	47	6	105	32	-	14	15	10.5	0.79

(.) = connection size (see Point 2.1: Type and size of connection)

NOTE

The information in this brochure relates to the operating conditions and applications described.
For applications or operating conditions not described, please contact the relevant technical department.
Subject to technical modifications.

HYDAC Filtrertechnik GmbH
Industriegebiet
D-66280 Sulzbach/Saar
Tel.: 0 68 97 / 509-01
Fax: 0 68 97 / 509-300
Internet: www.hydac.com
E-Mail: filter@hydac.com