

TA3155

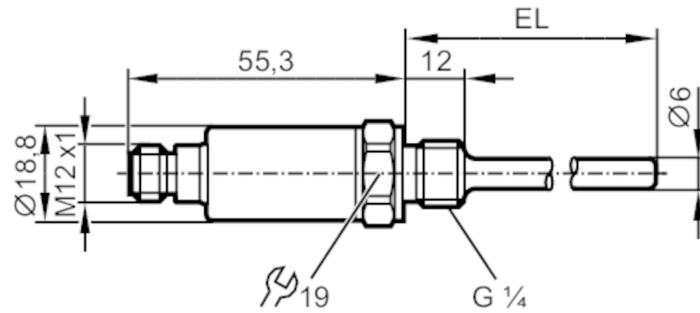

Temperature transmitter

TA-200CLEM14-A-ZVG/US



Product characteristics

Number of inputs and outputs	Number of analogue outputs: 1	
Measuring range	-50...150 °C	-58...302 °F
Process connection	threaded connection G 1/4 external thread	
Installation length EL [mm]	200	

Application

Special feature	Gold-plated contacts	
Measuring element	1 x Pt 1000; (to DIN EN 60751, class A)	
Media	liquids and gases	
Pressure rating [bar]	400	

Electrical data

Operating voltage [V]	10...30 DC; ("supply class 2" to cULus)	
Current consumption [mA]	< 30	
Protection class	III	
Reverse polarity protection	yes	

Inputs / outputs

Number of inputs and outputs	Number of analogue outputs: 1	
------------------------------	-------------------------------	--

Outputs

Total number of outputs	1	
Output signal	analogue signal	
Number of analogue outputs	1	
Analogue current output [mA]	4...20	
Max. load [Ω]	(U _b - 8,5 V) / 21,5 mA; 24 V: 720 Ω	
Short-circuit protection	yes	
Overload protection	yes	

Measuring/setting range

Measuring range	-50...150 °C	-58...302 °F
-----------------	--------------	--------------

Resolution

Resolution of analogue output [K]	0.04	
-----------------------------------	------	--

TA3155



Temperature transmitter

TA-200CLEM14-A-ZVG/US

Accuracy / deviations		
Precision analogue output [K]		$\pm 0,3 + (\pm 0,1 \% \text{ MS})$
Temperature coefficient [% of the span / 10 K]		0,1; (in case of deviation from the reference condition $25 \pm 5 \text{ }^\circ\text{C}$)
Response times		
Dynamic response T05 / T09 [s]		1 / 3; (to DIN EN 60751)
Operating conditions		
Ambient temperature [°C]		-40...100
Storage temperature [°C]		-40...100
Protection		IP 68; IP 69K
Tests / approvals		
EMC	DIN EN 61000-6-2	
	DIN EN 61000-6-3	
Shock resistance	DIN EN 60068-2-27	50 g (11 ms)
Vibration resistance	DIN EN 60068-2-6	20 g (10...2000 Hz)
MTTF [years]		1092
UL approval	UL Approval no.	K005
Mechanical data		
Weight [g]		155.5
Dimensions [mm]		$\varnothing 18.8$
Materials		stainless steel (1.4404 / 316L); PEI; FKM
Materials (wetted parts)		stainless steel (1.4404 / 316L); FKM
Process connection		threaded connection G 1/4 external thread
Probe diameter [mm]		6
Installation length EL [mm]		200
Remarks		
Remarks	The values for accuracy apply to flowing water. referring to UL: for use on a low voltage circuit with overcurrent protection in accordance with UL873 tab. 28.1 or $I_{\text{max}} = 100/U_b$ (U_b = voltage of the circuit)	
Pack quantity		1 pcs.
Electrical connection		
Connector: 1 x M12; Contacts: gold-plated		
		



TA3155



Temperature transmitter

TA-200CLEM14-A-ZVG/US

Connection

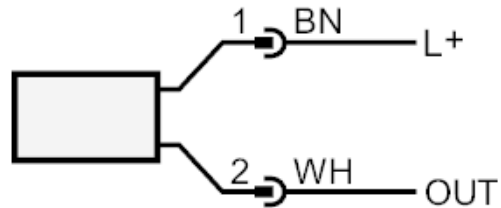

OUT: analogue output
colours to DIN EN 60947-5-2