

SPECIFICATION

FOR

EUROPEAN JUMPER CORDSET (PB FR)

CORD : H05VV-F 3X1.00mm² PVC LEAD FREE

CUSTOMER : VPE/FARNELL

CUSTOMER'S PART No. : 1702766

VOLEX'S SPEC. REF. No. : 143023/7

ISSUE No. : 001

DATE : 30TH OCTOBER 2014

CUSTOMER APPROVED :

APPROVED BY :	
SIGNATURE :	
APPROVED DATE :	
No. OF PAGES :	









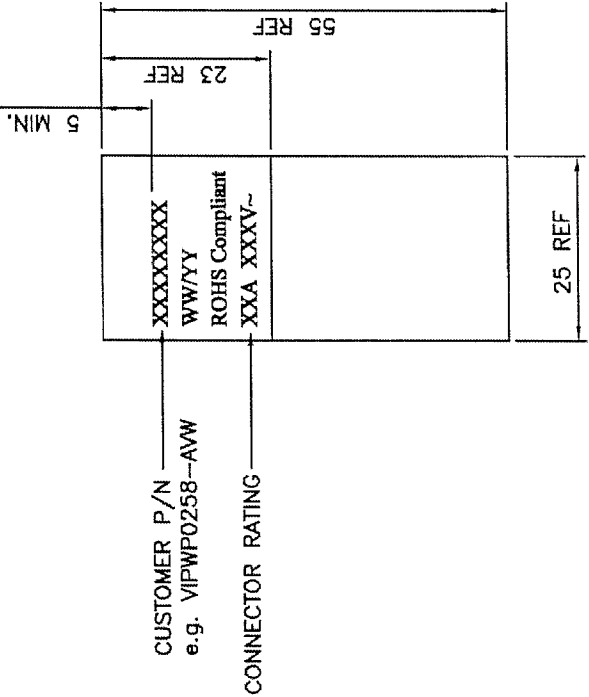



Volex (Asia) Pte Ltd

35 Tampines St. 92
Singapore 528880
Tel : (65) 6788 7833
Fax : (65) 6788 7822

DRAWING NUMBER : VL-0356
 REVISION : D



- NOTES :**
1. ALL DIMENSION IN MM.
 2. GENERAL TOLERANCE ±2MM, UNLESS OTHERWISE SPECIFIED.
 3. WHITE BACKGROUND WITH BLACK PRINT.
 4. FONT: TIMES NEW ROMAN; HEIGHT: 2.0MM.
 5. PRINTED MARKING SHALL BE DURABLE & LEGIBLE, SURFACE RUBBED WITH THUMB PRESSURE BACK & FORTH 10X, AND INK SHOULD NOT SMEAR.
 6. PRINTER/RIBBON TYPE: TEC B-572 OR TEC B-672/905019 OR 905034.
 7. FOR PN WITH THE CHARACTERS >=10, USE VL0356-1 TO PRINT.  FOR PN WITH THE CHARACTERS <10, USE VL0356-2 TO PRINT. 

S/N.	DESCRIPTION	ITEM NO.	REMARKS																																								
1	TRANSPARENT OPP LABEL 55X25MM	6102464																																									
<table border="1"> <tr> <td colspan="2">TITLE :</td> <td colspan="2">WRAPAROUND CORD LABEL 25X55MM</td> </tr> <tr> <td>PRINT FILE :</td> <td>FILENAME :</td> <td>SCALE :</td> <td>PAGE :</td> </tr> <tr> <td>VL0356D </td> <td>..\\LABEL\\HOUSE-VL\\VL-0356</td> <td>1 : 1</td> <td>1 / 1</td> </tr> </table>				TITLE :		WRAPAROUND CORD LABEL 25X55MM		PRINT FILE :	FILENAME :	SCALE :	PAGE :	VL0356D 	..\\LABEL\\HOUSE-VL\\VL-0356	1 : 1	1 / 1																												
TITLE :		WRAPAROUND CORD LABEL 25X55MM																																									
PRINT FILE :	FILENAME :	SCALE :	PAGE :																																								
VL0356D 	..\\LABEL\\HOUSE-VL\\VL-0356	1 : 1	1 / 1																																								
<table border="1"> <tr> <th>DRAWN :</th> <th>ALICE</th> <th>REV</th> <th>SRN/ECR</th> <th>BY</th> <th>DATE</th> <th>REV</th> <th>SRN/ECR</th> <th>BY</th> <th>DATE</th> </tr> <tr> <td>RELEASED :</td> <td>05/12/07</td> <td>A</td> <td>H612-018-07</td> <td>ALICE</td> <td>10/12/07</td> <td>B</td> <td>080027</td> <td>ALICE</td> <td>14/01/08</td> </tr> <tr> <td>CHECKED :</td> <td></td> <td>C</td> <td>120686</td> <td>ALICE</td> <td>03/09/12</td> <td>D</td> <td>130243</td> <td>ALICE</td> <td>15/03/13</td> </tr> <tr> <td>APPROVED :</td> <td></td> <td></td> <td></td> <td></td> <td></td> <td></td> <td></td> <td></td> <td></td> </tr> </table>				DRAWN :	ALICE	REV	SRN/ECR	BY	DATE	REV	SRN/ECR	BY	DATE	RELEASED :	05/12/07	A	H612-018-07	ALICE	10/12/07	B	080027	ALICE	14/01/08	CHECKED :		C	120686	ALICE	03/09/12	D	130243	ALICE	15/03/13	APPROVED :									
DRAWN :	ALICE	REV	SRN/ECR	BY	DATE	REV	SRN/ECR	BY	DATE																																		
RELEASED :	05/12/07	A	H612-018-07	ALICE	10/12/07	B	080027	ALICE	14/01/08																																		
CHECKED :		C	120686	ALICE	03/09/12	D	130243	ALICE	15/03/13																																		
APPROVED :																																											

REV.	DESCRIPTION	DATE
I	REMOVE INSULATION COLOR 'BLUE, BROWN, BLACK'	01/09/06
	FM. REV. H PER HD STANDARD.	
J	CHANGE THE COMPLIANCE STANDARD	23/12/13
	PER SAFETY.	
	UPDATE FORMAT AS SHOWN.	

1. PVC FLEXIBLE CORD

1.1 SCOPE

This specification shall be in accordance with EN 50525-2-11. 

1.2 CONSTRUCTION

CONDUCTOR	ANNEALED COPPER WIRE
INSULATION	PVC (BLUE, BROWN, GREEN&YELLOW)
JACKET	PVC

ITEM	UNIT	SPEC. VALUE	
TEMPERATURE RATING	°C	70	
RATED VOLTAGE	V	300/500	
NO. OF CORE	NO.	3	
CONDUCTOR NOMINAL AREA	mm ²	1.00	
MIN. AVE. THICKNESS OF INSULATION	mm	0.60	
MIN. THICKNESS AT ANY POINT OF INSULATION	mm	0.44	
MIN. AVE. THICKNESS OF JACKET	mm	0.80	
MIN. THICKNESS AT ANY POINT OF JACKET	mm	0.58	
OVERALL DIAMETER OF JACKET	mm	6.3~8.0	
DIELECTRIC-STRENGTH TEST IMMERSSED IN WATER, 20±5°C FOR MINIMUM 1HR	ON COMPLETED CABLE	—	2000 V FOR 15 MINS (MINIMUM)
	ON CORES	—	1500 V FOR 5 MINS (MINIMUM)
VOLTAGE TEST (D.C)	—	—	2000 Va.c FOR 5 MINS (MINIMUM) OR 5000 Vd.c FOR 5 MINS (MINIMUM)
INSULATION RESISTANCE TEST (70°C)	MΩ km	> 0.01	
CONDUCTOR RESISTANCE TEST (20°C)	Ω /km	<= 19.5	

TITLE : CABLE SPECIFICATION
EUROPEAN APPROVED POWER SUPPLY CABLE
H05VV-F 3X1.00mm²



SPEC NO. : CS-048EU	APPROVED BY :	CHECKED BY :	DRAWN BY :	REVISION :	 Voilex (Asia) Pte Ltd <small>Confidential property of Voilex. Information contained herein shall not be disclosed to others, reproduced or used for any other purposes except as authorized in writing by an authorized official of voilex asia.</small>
	DATE :	DATE :	DATE :	PAGE :	
	<i>[Signature]</i>	<i>[Signature]</i>	HONGYAN	J	
	30/12/13	27/12/13	23/12/13	1/1	

REV.	DESCRIPTION	DATE
A	INITIAL RELEASE.	12/10/02
B	UPDATE MARKING DETAILS.	19/01/05
	UPDATE THE FORMAT AS SHOWN.	
	ADD IN '(EU/SAA/SAB/IEC)' ON THE TITLE.	

CABLE MARKING

BAO HING (SHENZHEN)

 H05VV-F 3G1.0mm² <VDE> KEMA-KEUR +s+s+s
 <ÖVE> CEPEC IEMMEQU SABS 1574 (S) (N) (D) (FI)
 BAOHING GTSA-3 N14586 CE LF

DRAWN	LI XF	19/01/05	FILENAME :	TITLE : CABLE MARKING (EU/SAA/SAB/IEC) 
CHECK	<i>wait</i>	19/1/05	CABLE MARKING/ BH/H05/H05VV-F	
APPR	<i>chongpin</i>	19/01/05	3X1.0 LF- BH	
SCALE	N.T.S.	REV.	B	
REFERENCE :				Volex (Asia) Pte Ltd <small>Confidential property of Volex. Information contained herein shall not be disclosed to others. reproduced or used for any other purposes except as authorized in writing by an authorized official of volex asia.</small> 
H05VV-F 3X1.0mm ² LF				

REV.	DESCRIPTION	DATE
	UPDATE FORMAT AS SHOWN.	
C	ADD IN '(EU/SAA/SAB/IEC)' ON THE TITLE.	21/01/05
	ADD IN NEW MARKING PER ECN002-13.	
D	ADD IN NOTE 1.	07/05/13

CABLE MARKING

TONG YUAN (SHENZHEN)

H05W-F 3G1.0mm² <VDE> KEMA-KEUR CEBC +++++ <ÖVE>

ⓉⓈⓃⓕ IEMMEQU S/370 SABS 1574 NF-USE TONGYUAN LF



H05W-F 3G1.0mm² <VDE> KEMA-KEUR CEBC +++++ <ÖVE>

ⓉⓈⓃⓕ IEMMEQU SABS 60227-5 NF-USE 1321FC TONGYUAN LF

NOTES:

- 1) * - PREFERRED CABLE MARKING.

DRAWN	HONGYAN	07/05/13	FILENAME :	TITLE : CABLE MARKING (EU/SAA/SAB/IEC)
CHECK	<i>[Signature]</i>	09/05/13	C-MARKING/TONG	
APPR	<i>[Signature]</i>	11/5/13	YUAN/H05/H05W	
SCALE	N.T.S.	REV.	D	
REFERENCE :				Volex (Asia) Pte Ltd
H05W-F 3X1.0mm ² LF				
<small>Confidential property of Volex. Information contained herein shall not be disclosed to others, reproduced or used for any other purpose except as authorized in writing by an authorized official of Volex Asia.</small>				

3. CONNECTOR

REV	DESCRIPTION	DATE
	CHANGE 'TEST RESULT' TO 'ACCEPTANCE CRITERIA'.	
S	CHANGE FORMAT AS SHOWN.	11/03/13
T	ADD IN CATALOGUE NO. 'VAC14LA'.	03/06/13

3.1. SCOPE

The connector shall be in accordance with IEC 60320-2-2 / EN 60320-2-2 & IEC 60320-1 / EN 60320-1 : Test specification - appliance couplers.

3.2. CONSTRUCTION

The connector construction shall comply with our catalogue No: VAC14S, VAC14A, VAC20S, VAC14LS, VAC14KC, VAC14KAL, VAC14KAR, VAC14LA, VAC20KAL, VAC20KAR & VAC20KC.

"All Connectors complying to Standard Sheet C14 and C20"

3.3. CHARACTERISTICS

NO.	TEST ITEM	DESCRIPTION	ACCEPTANCE CRITERIA
1.	Moisture resistance test	Samples are kept in a humidity cabinet containing air with a relative humidity between 91 to 95% and a temperature of 20°C-30°C for a duration of 48 hours.	No damage
2.	Electric strength test	Voltages of 3000V±60V and 1500V±60V, with min. trip current of 100mA is applied for 60s±5s between current-carrying contacts and body and between each contacts respectively after the moisture resistance tests.	No flashover and breakdown
3.	Insulation resistance test	This test is measured with a D.C 500V after the moisture resistance test. Readings are taken after 60s ± 5s of application of voltage.	Min. 5 M Ohm
4.	Glow wire test	Glow wire is applied for 30s with temperature of 750°C on inserts and housings retaining contacts and 650°C on elsewhere.	Flame (if any) shall be self-extinguished within 30s . upon the removal of the glow wire and molten droplets shall not ignite paper.

DRAWN:	XIAOZHI	03/06/13	TITLE : EUROPEAN & BRITISH PLUG CONNECTOR
CHECK:	<i>hong</i>	03/06/13	
APPR:	<i>WZ</i>	3/6/13	
REV:	T		
REFERENCE:			Volex (Asia) Pte Ltd
			<small>Confidential property of Volex. Information contained herein shall not be disclosed to others, reproduced or used for any other purposes except as authorized in writing by an authorized official of volex asia.</small>

NO.	TEST ITEM	DESCRIPTION	ACCEPTANCE CRITERIA
5.	Bending test	The sample shall be loaded with a weight of 10N for 0.75mm ² or 20N for 1.00mm ² or bigger and the oscillating member shall be moved backward and forward through an angle of 90°(45° on either side of the vertical) the number of flexing being 20,000. A rated current is applied. For round cord, the sample is turned 90 degree around the axis of cable after 10,000 cycles. The flexing is further completed in this axis. Flat cable is flexed only along the bigger axis of the cable.	There shall be no complete breakage of any of the conductor. Broken conductor shall not have pierced the insulation.
6.	Tumbling test	The sample is dropped from a height of 50cm onto a steel plate(3mm thick) for a total of 500 times.	No damage to impair further use of connector.
7.	Temperature rise test	An alternating current at 1.25 times rated current is passed through the current carrying contacts for 1 hour. This is repeated for connector with earth contact passing current between earth and each of the current carrying contacts.	The temperature rise shall not exceed 45K.
8.	Cord-anchorage test	The cord is subjected to pulls of 50N(2.5A) or 60N(others) for 100 times each time for 1 sec. without jerk. Thereafter the cord is subjected for 1 min. to a torque of 0.15Nm(0.75mm ²) or 0.25Nm(others).	The cord shall not be damaged and shall not be displaced by more than 2mm.
9.	Heat deformation test	Samples are kept for 1 hour in a heating cabinet at temperature of 100±2°C.	No damage to impair further use of connector.
10.	Heat pressure test	A pressure of 20N is applied at a temperature of 100°C ± 2°C for 1 hour.	No damage to impair further use of connector.
11.	Aging test	The samples are kept for 168 hours in a heating cabinet at a temperature of 80±2°C.	No damage & marking shall be legible.
12.	Ball pressure test	A ball of 5mm in diameter is applied on the connector with the following temperature with 20N force for 1 hour. i) 125°C for hot connectors. ii) 125°C for parts retaining current carrying parts and earth circuit. iii) 75°C for other parts for cold connector. The connector is then cooled down to room temperature with cold water.	The diameter of the impression shall not exceed 2mm.

DRAWN:	XIAOZHI	03/06/13	TITLE : EUROPEAN & BRITISH PLUG CONNECTOR
CHECK:	<i>[Signature]</i>	03/06/13	
APPR:	<i>[Signature]</i>	3/6/13	
REV:	T		
REFERENCE:			Volex (Asia) Pte Ltd <small>Confidential property of Volex. Information contained herein shall not be disclosed to others. reproduced or used for any other purposes except as authorized in writing by an authorized official of volex asia.</small>

3. CONNECTOR

REV	DESCRIPTION	DATE
	CHANGE 'TEST RESULT' TO 'ACCEPTANCE CRITERIA'	
AP	CHANGE FORMAT AS SHOWN.	11/03/14
AQ	ADD IN CATALOGUE NO. VAC17KS.	24/02/14

3.1. SCOPE

The connector shall be in accordance with IEC 60320-1 or EN 60320-1, Test specification - appliance couplers.

3.2. CONSTRUCTION

The connector construction shall comply with our catalogue No: VAC5S, APC5A, APC5S, APC5M, VAC5AR, APC5SM, DLC5A3, V1625, V1625A, VAC19, VAC17S, VSCC13, AVL13, APC13, APC13S, VSC19, V1625LA, VAC19A, VSCC15, APC5SP, APC13F, V1625BS, APC13G, VAC13A, VAC13S, PIC17S, VIC13A, DLC5U3, VAC13KS, SOC5S, V1625H, VAC19KS, DLC5E3, HPC13A, V1625AT, VAC17A, APC5SF, VCC13, VCC5S, APC13H, VCC17S, VAC19H, APC13FH, APC13HC & VAC17KS "All connectors complying to Standard Sheet C5, C13, C15, C15A, C17 and C19"

3.3. CHARACTERISTICS

NO.	TEST ITEM	DESCRIPTION	ACCEPTANCE CRITERIA
1.	Moisture resistance test	Samples are kept in a humidity cabinet containing air with a relative humidity between 91 to 95% and a temperature of 20°C-30°C for a duration of 48 hours.	No damage
2.	Electric strength test	Voltages of 3000V±60V and 1500V±60V, with min. trip current of 100mA is applied for 60s±5s between current-carrying contacts and body and between each contacts respectively after the moisture resistance tests.	No flashover and breakdown
3.	Insulation resistance test	This test is measured with a D.C 500V after the moisture resistance test. Readings are taken after 60s ± 5s of application of voltage.	Min. 5 M Ohm
4.	Withdrawal force test	<p>i) Min. 1.5N (2N for 16A) - A single pin made to the minimum dimension is inserted into the connector. The pin, together with the weight should exert a force of 1.5N (2N for 16A connector). Each individual pole of the connector is tested separately.</p> <p>ii) Max. 50N (60N for 16A) - Insert and withdraw the connector from a socket having pin dimension to the maximum and shroud dimension to the minimum for 10 times. The connector is then inserted again into the socket hang with a total weight of 50N(60N for 16A). The weight consist of a principal weight which is 90% of the total weight and a supplementary weight of 10%.</p> <p>The test is repeated for hot connector with temperature of 120°C±2°C on the pins.</p>	<p>i) The pin with the weight should not be withdrawn from the connector for more than 3 seconds.</p> <p>ii) The connector shall be withdrawn from the socket. If not the supplementary weight is lifted from a height of 5cm and drop. The connector must be withdrawn.</p> <p>The test is repeated after temperature rise test.</p>

DRAWN:	MOLLY	24/02/14	TITLE: EUROPEAN & BRITISH APPLIANCE COUPLERS
CHECK:	<i>[Signature]</i>	24/02/14	
APPR:	<i>[Signature]</i>	24/2/14	
REV:	AQ		
REFERENCE:			Voilex (Asia) Pte Ltd
			<small>Confidential property of Voilex. Information contained herein shall not be disclosed to others, reproduced or used for any other purposes except as authorized in writing by an authorized official of voilex asia.</small>

NO.	TEST ITEM	DESCRIPTION	ACCEPTANCE CRITERIA
5.	Glow wire test	Glow wire is applied for 30s with temperature of 750°C on inserts and housings retaining contacts and 650°C on elsewhere.	Flame (if any) shall be self-extinguished within 30s. upon the removal of the glow wire and molten droplets shall not ignite paper.
6.	Bending test	The sample shall be loaded with a weight of 10N for 0.75mm ² or 20N for 1.00mm ² or bigger and the oscillating member shall be moved backward and forward through an angle of 90°(45° on either side of the vertical) the number of flexing being 20,000. A rated current is applied. For round cord, the sample is turned 90 degree around the axis of cable after 10,000 cycles. The flexing is further completed in this axis. Flat cable is flexed only along the bigger axis of the cable.	There shall be no complete breakage of any of the conductor. Broken conductor shall not have pierced the insulation.
7.	Tumbling test	The sample is dropped from a height of 50cm onto a steel plate(3mm thick) for a total of 500 times.	No damage to impair further use of connector.
8.	Breaking capacity test	The connector is connected and disconnected 50 times (100 strokes) with the inlet at a rate of 30 strokes per minute with 275V and 1.25 times of rated current.	No flashover or sustained arcing during the test and no damage to impair further use of connector.
9.	Normal operation test	Test is similar to breaking capacity except that the test voltage is 250V with the connector connected and disconnected with the inlet for 1000 times (2000 strokes) with rated current and 3000 times (6000 strokes) without current.	Withstand electric strength at 1500V for 1 min, and show no damage.
10.	Temperature rise test	An alternating current at 1.25 times rated current is passed through the current carrying contacts for 1 hour. This is repeated for connector with earth contact passing current between earth and each of the current carrying contacts.	The temperature rise shall not exceed 45K.
11.	Cord-anchorage test	The cord is subjected to pulls of 50N(2.5A) or 60N(others) for 100 times each time for 1 sec. without jerk. Thereafter the cord is subjected for 1 min. to a torque of 0.15Nm(0.75mm ²) or 0.25Nm(others).	The cord shall not be damaged and shall not be displaced by more than 2mm.
12.	Heat deformation test	Samples are kept for 1 hour in a heating cabinet at temperature of 100±2°C.	No damage to impair further use of connector.
13.	Heat pressure test	A pressure of 20N is applied at a temperature of 100°C ± 2°C for 1 hour.	No damage to impair further use of connector.

DRAWN:	MOLLY	24/02/14	TITLE:
CHECK:	<i>[Signature]</i>	24/02/14	EUROPEAN & BRITISH
APPR:	<i>[Signature]</i>	24/2/14	APPLIANCE COUPLERS
REV:	AQ		
REFERENCE:			<i>Volex (Asia) Pte Ltd</i>
			<small>Confidential property of Volex. Information contained herein shall not be disclosed to others, reproduced or used for any other purposes except as authorized in writing by an authorized official of volex asia.</small>

NO.	TEST ITEM	DESCRIPTION	ACCEPTANCE CRITERIA
14.	Aging test	The samples are kept for 168 hours in a heating cabinet at a temperature of 80±2°C.	No damage & marking shall be legible.
15.	Ball pressure test	A ball of 5mm in diameter is applied on the connector with the following temperature with 20N force for 1 hour. i) 125°C for hot connectors. ii) 125°C for parts retaining current carrying parts and earth circuit. iii) 75°C for other parts for cold connector. The connector is then cooled down to room temperature with cold water.	The diameter of the impression shall not exceed 2mm.

DRAWN:	MOLLY	24/02/14	TITLE:
CHECK:	<i>[Signature]</i>	24/02/14	EUROPEAN & BRITISH
APPR:	<i>[Signature]</i>	24/2/14	APPLIANCE COUPLERS
REV:	AQ		
REFERENCE:			<i>Volex (Asia) Pte Ltd</i>
			<small>Confidential property of Volex. Information contained herein shall not be disclosed to others. reproduced or used for any other purposes except as authorized in writing by an authorized official of volex asia.</small>

REV.	DESCRIPTION	DATE
G	UPDATE FORMAT AS SHOWN. REMOVE THE CLOSED FACTORY FM. MANU. LOC. MARK.	03/11/06
H	REMOVE THE CLOSED FACTORY FROM MANU. LOCATION MARK.	23/07/09

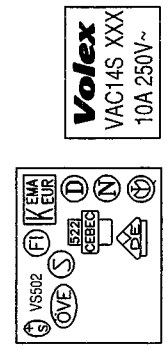
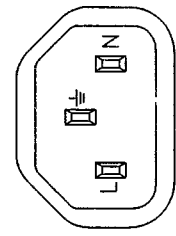
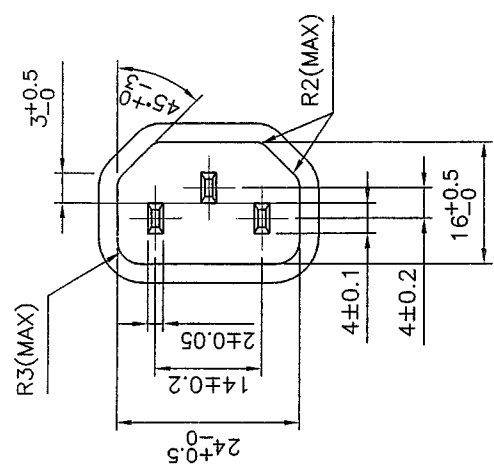
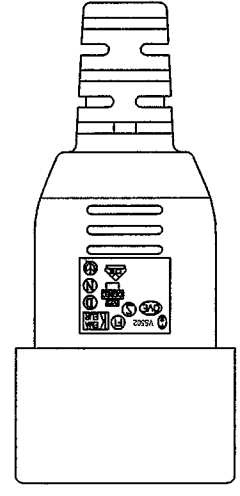
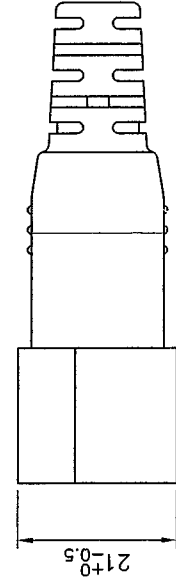
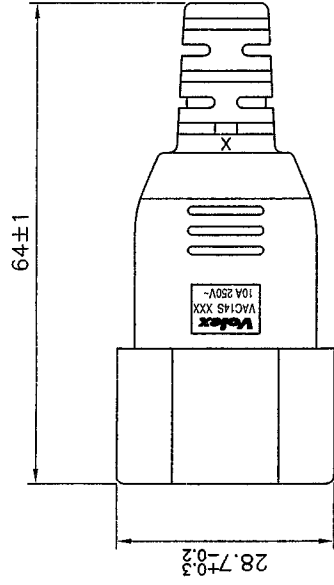

MARKING DETAILS :

- NOTES :**
- 1.) ALL DIMENSIONS IN mm.
 - 2.) X - CAVITY NO. (OPTIONAL)
 - 3.) XXX - MANUFACTURING LOCATION.

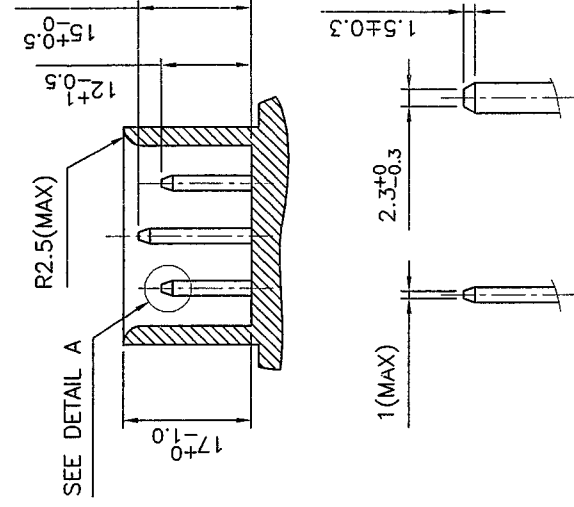

DETAIL A

TITLE :		FILE NAME :		DRAWN :		CHECK :		APPR :		REV. :		SCALE :		REFERENCE :	
MOLDED PLUG CONNECTOR		A-CONNECTOR/ EURO/GENERAL/ VAC14S-EURO		QIAN SM		hengsh		30/7/09		H		N.T.S.		EUROPEAN APPROVAL	
VAC14S														<p>MANUFACTURE LOCATION MARK</p> <p>(' X ' IS APPLICABLE ONLY)</p>	
Volex (Asia) Pte Ltd															
<small>Confidential property of Volex. Information contained herein shall not be disclosed to others, reproduced or used for any other purposes except as authorized in writing by an authorized official of Volex Asia.</small>															

REV.	DESCRIPTION	DATE
J	UPDATE FORMAT AS SHOWN. REMOVE THE CLOSED FACTORY FM. MANU. LOC. MARK.	02/11/06
K	REMOVE THE CLOSED FACTORY FROM MANU. LOCATION MARK.	23/07/09

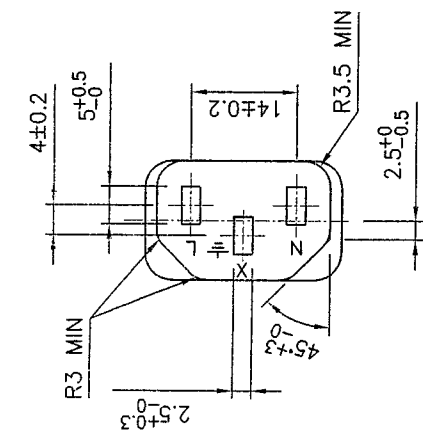

Voilex V1625
10A 250V ~ XXX

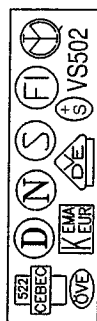

MARKING DETAILS

5.7^{+1.5}₋₀

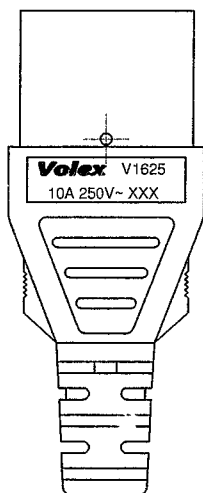
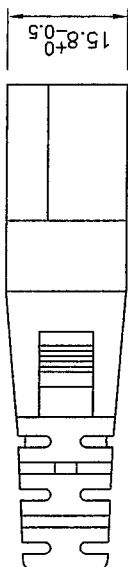
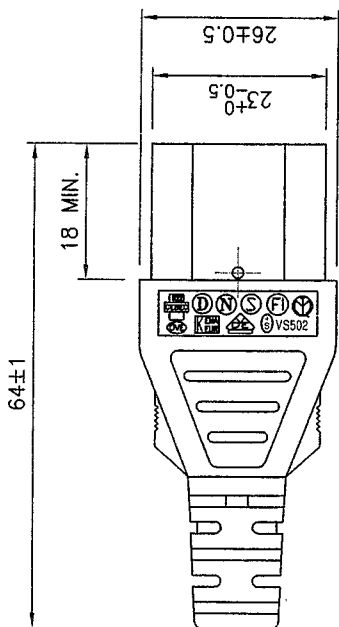
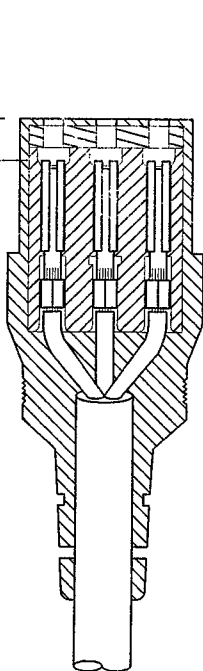

HENG GANG (CHINA)		X	DRAWN	QIAN SM	23/07/09	FILE NAME :	TITLE :		
SM1	ZHONGSHAN (CHINA)	X	CHECK	henggh	>10/09	A CONN/EURO/ GENERAL/V1625- EUROPEAN	MOLDED CONNECTOR V1625		
VH	HANOI (VIETNAM)	X	APPR	Wang	30/7/9				
B	BATAM (INDONESIA)	X	REV.	K	SCALE	N.T.S.			
VC	CHENNAI (INDIA)	X	REFERENCE :						
MANUFACTURE LOCATION MARK (' X ' IS APPLICABLE ONLY)		EUROPEAN APPROVAL							
		Voilex (Asia) Pte Ltd							



NOTES :

- 1.) ALL DIMENSIONS IN mm.
- 2.) X - CAVITY NO. (OPTIONAL)
- 3.) XXX - MANUFACTURING LOCATION

Confidential property of Voilex.
Information contained herein shall not be disclosed to others,
reproduced or used for any other purpose except as
authorized in writing by an authorized official of Voilex asia.