

Product Data Sheet

8315100253

VWS0112EUGAS

AR126-00253 12V P/2

Rev 4.200

**ebmpapst**

engineering a better life



AR126-00253 12V P/2 Rev 4.200

**INDEX**

<b>1</b>	<b>General .....</b>	<b>3</b>
<b>2</b>	<b>Mechanics .....</b>	<b>3</b>
2.1	General .....	3
2.2	Connections .....	3
<b>3</b>	<b>Operating Data .....</b>	<b>5</b>
3.1	Electrical Interface - Input .....	5
3.2	Electrical Operating Data .....	6
3.3	Electrical Interface - Output .....	7
3.4	Electrical Features .....	8
3.5	Aerodynamics .....	9
3.6	Sound Data .....	11
<b>4</b>	<b>Environment .....</b>	<b>11</b>
4.1	General .....	11
4.2	Climatic Requirements .....	11
4.3	Mechanical Requirements .....	12
4.4	EMC .....	12
<b>5</b>	<b>Safety .....</b>	<b>14</b>
5.1	Electrical Safety .....	14
5.2	Approval Tests .....	14
<b>6</b>	<b>Reliability .....</b>	<b>14</b>
6.1	General .....	14

**1 General**

Fan type	Axial	
Rotating direction looking at rotor	Clockwise - reversible	
Airflow direction	Air inlet and air outlet axially	
Bearing system	Ball bearing	
Mounting position - shaft	Any	

**2 Mechanics****2.1 General**

Width	126 mm	
Height	123 mm	
Depth	26,4 mm	
Diameter	126 mm	
Mass	0,17 kg	
Housing material	Plastic	
Impeller material	Plastic	

**2.2 Connections**

Electrical connection	Wires	
Lead wire length	L = 310 mm	
Tolerance	+ - 10 mm	
Wire size (AWG)	26	
Insulation diameter		

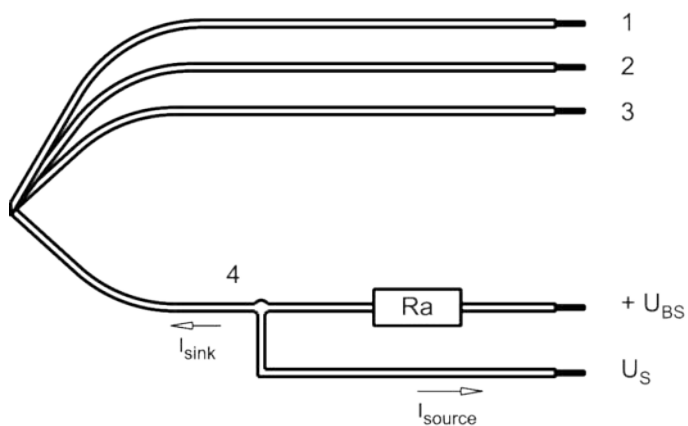

Wire	Color	Operation
1	red	+ UB
2	blue	- GND
3	violet	CTRL
4	white	Tacho

### 3 Operating Data

#### 3.1 Electrical Interface - Input

Control input	PWM
---------------	-----

#### Features

Input type	Open collector	
PWM - Frequency		1 kHz - 5 kHz typical: 2 kHz

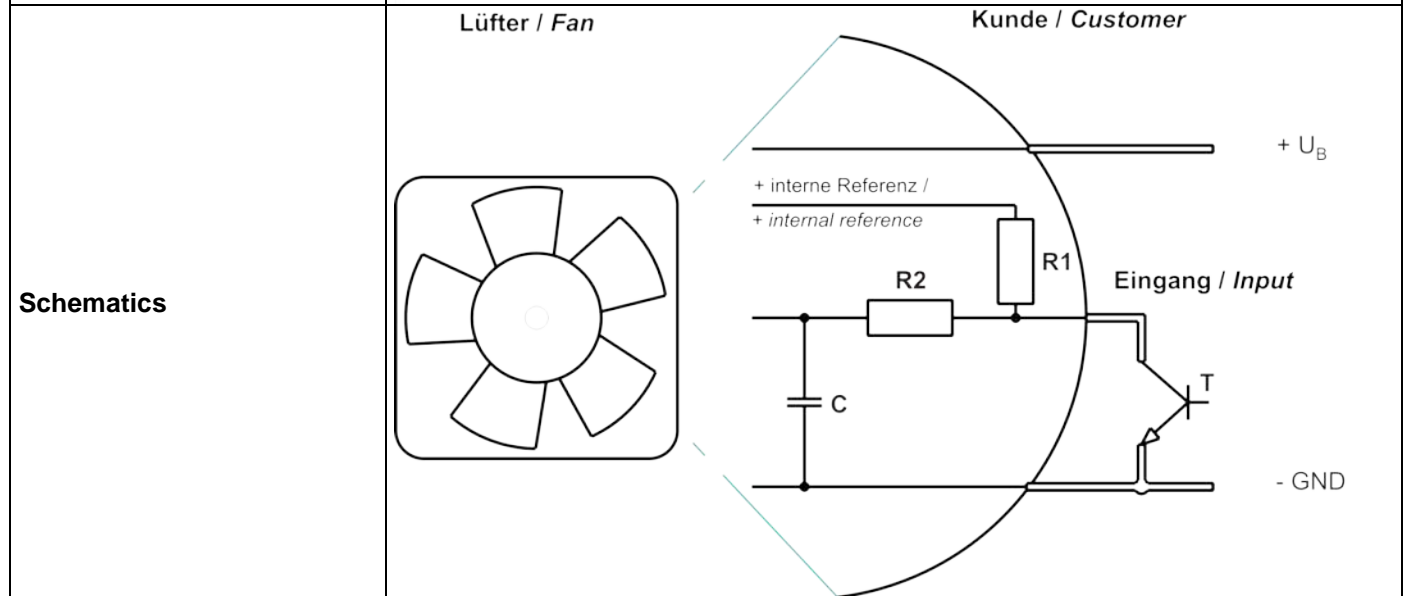
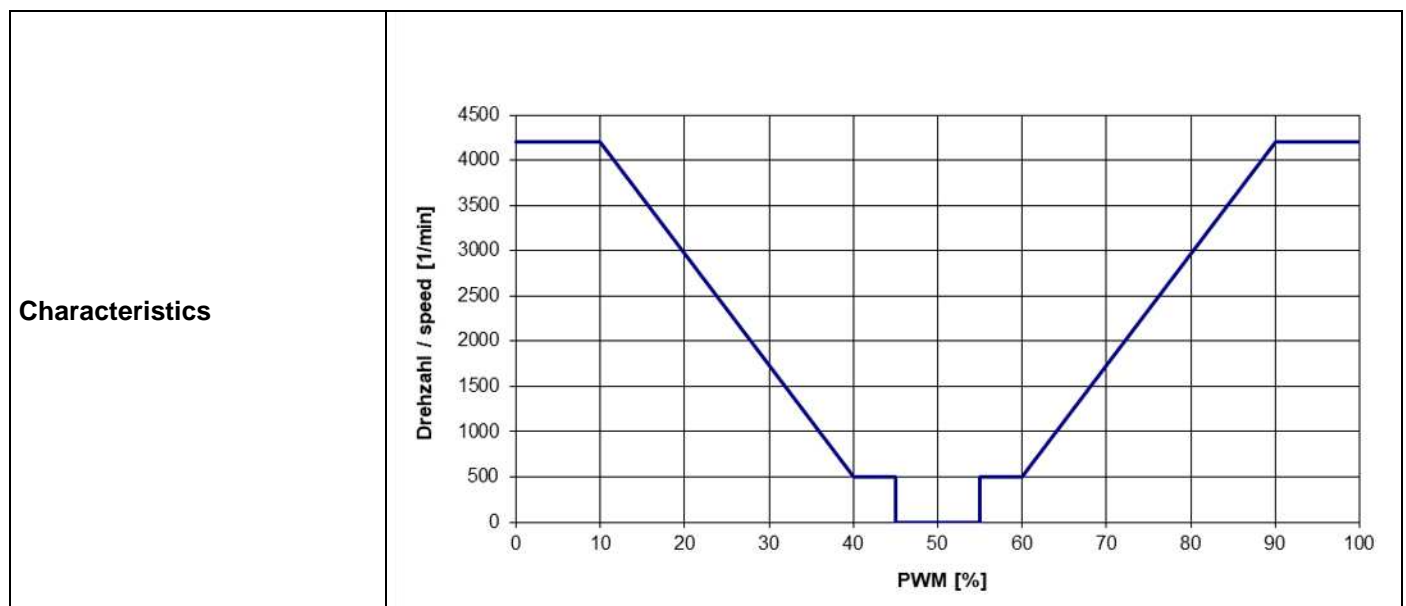

When 50% PWM is applied to the control input, the fan brakes actively from a speed of less than or equal to 2600 rpm so that the rotor stops immediately.

### 3.2 Electrical Operating Data

Measurement conditions: Normal air density = 1,2 kg/m<sup>3</sup>; Temperature 23°C +/- 3°C; Motor axis horizontal; warm-up time before measuring 5 minutes. In the intake and outlet area should not be any solid obstruction within 0,5 m.

$\Delta p = 0$ : corresp. to free air flow (see chapter aerodynamics)  
I: corresp. to arithm. mean current value

Name	Condition
PWM 0001	PWM: 5 %; f: 2 kHz

Features	Condition	Symbol	Values		
Voltage range		U	10,8 V		13,2 V
Nominal voltage		U <sub>N</sub>		12 V	
Power consumption	$\Delta p = 0$	P	2,4 W	2,5 W	2,6 W
Tolerance	PWM 0010		+/- 12 %	+/- 12 %	+/- 12 %
Current consumption	$\Delta p = 0$	I	220 mA	210 mA	200 mA
Tolerance	PWM 0010		+/- 12 %	+/- 12 %	+/- 12 %
Speed	$\Delta p = 0$	n	4.200 1/min	4.200 1/min	4.200 1/min
Tolerance	PWM 0010		+/- 10 %	+/- 10 %	+/- 10 %

3.3 Electrical Interface - Output

Tacho type	/2 (open collector)
------------	---------------------

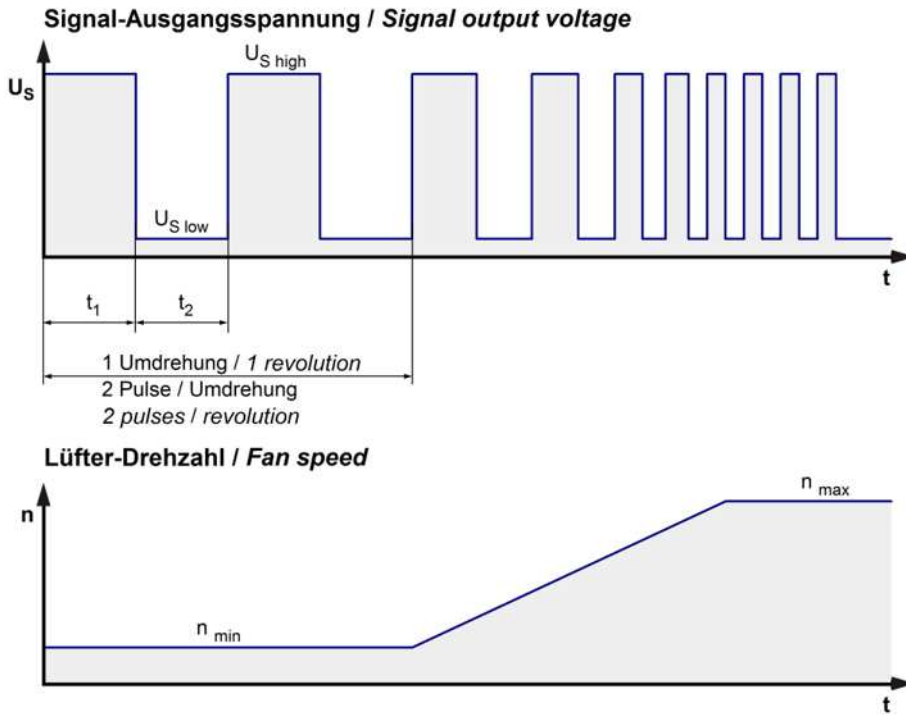

$$R_a = \frac{U_{BS} - U_{S\ low}}{I_{sink}}$$

Lüfter / Fan      Kunde / Customer

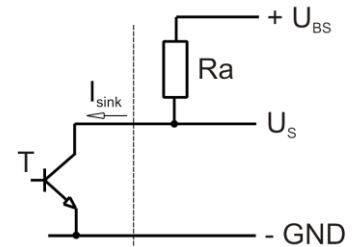

Features	Note	Values
Tacho operating voltage	$U_{BS}$	$\leq 30\text{ V}$
Tacho signal Low	$U_{S\ low}$	$\leq 0,4\text{ V}$
Tacho signal High	$U_{S\ high}$	$\leq 30\text{ V}$
Maximum sink current	$I_{sink}$	$\leq 4\text{ mA}$
Maximum source current		$0\text{ mA}$
External resistor	External resistor $R_a$ from $U_{BS}$ to $U_S$ required. All voltages measured to GND.	
Tacho frequency	$(2 \times n) / 60$	$140\text{ Hz @ } 4.200\text{ 1/min}$

n = revolutions per minute (1/min)

### 3.4 Electrical Features

Electronic function	Speed-Controlled	
Reversed polarity protection	Rectifying diode	
Max. residual current at $U_N$	$I_F \leq 15 \text{ mA}$	
Locked rotor protection	Auto restart	
Locked rotor current at $U_N$	$I_{\text{block}}$ approx. 70 mA	
Clock signal at locked rotor	$t_3 / t_4$ typical: 2 s / 2 s	



**3.5 Aerodynamics**

Measurement conditions: Measured with a double chamber intake rig acc. to DIN EN ISO 5801.  
 Normal air density = 1,2 kg/m<sup>3</sup>; Temperature 23°C +/- 3°C;  
 In the intake and outlet area should not be any solid obstruction within 0,5 m. Motor shaft horizontal.  
 The information is only valid under the specified test conditions and may be changed by the installation conditions. If there are deviations from the standard test conditions, the characteristic values must be checked under the installed conditions. Power consumption of the fan motor when operating at normal voltage is shown. Depending on the operating conditions of the application, the power input may be higher.

a.) Operation condition:

4.200 1/min at free air flow	PWM 5 %; f: 2 kHz		
------------------------------	-------------------	--	--

Max. free-air flow ( $\Delta p = 0 / \dot{V} = \text{max.}$ )	130 m <sup>3</sup> /h	
Max. static pressure ( $\Delta p = \text{max.} / \dot{V} = 0$ )	102 Pa	

130 m<sup>3</sup>/h Air outlet over struts, 135 m<sup>3</sup>/h Air intake over struts.

b.) Operation condition:

4.200 1/min at free air flow	PWM 95 %; f: 2 kHz		
------------------------------	--------------------	--	--

Max. free-air flow ( $\Delta p = 0 / \dot{V} = \text{max.}$ )	135 m <sup>3</sup> /h	
Max. static pressure ( $\Delta p = \text{max.} / \dot{V} = 0$ )	98 Pa	

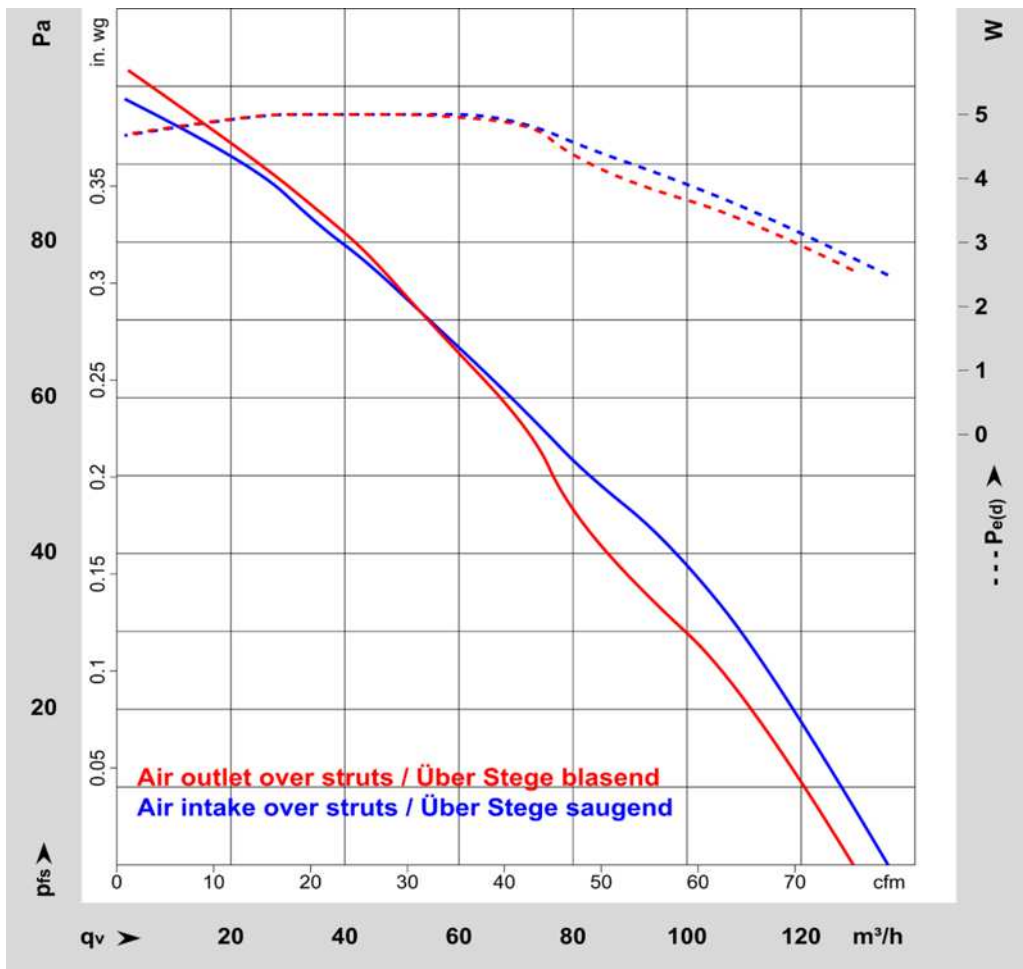

**3.6 Sound Data**

Measurement conditions: Sound pressure level: 1 meter distance between microphone and the air intake.  
 Sound power level: According to ISO 13347-3. Sound power level: According to ISO 13347-3.  
 Measured in a semianechoic chamber with a background noise level of  $L_p(A) < 5 \text{ dB(A)}$   
 For further measurement conditions see chapter aerodynamics.

a.) Operation condition:

4.200 1/min at free air flow	PWM 5 %; f: 2 kHz		
------------------------------	-------------------	--	--

Optimal operating point	130 m <sup>3</sup> /h @ 0 Pa		
Sound power level at the optimal operating point	6,2 bel(A)		
Sound pressure level at free air flow, measured in rubber bands	52 dB(A)		

b.) Operation condition:

4.200 1/min at free air flow	PWM 95 %; f: 2 kHz		
------------------------------	--------------------	--	--

Optimal operating point	135 m <sup>3</sup> /h @ 0 Pa		
Sound power level at the optimal operating point	6,5 bel(A)		
Sound pressure level at free air flow, measured in rubber bands	55 dB(A)		

**4 Environment**

**4.1 General**

Min. permitted ambient temperature TU min.	-20 °C		
Max. permitted ambient temperature TU max.	60 °C		
Min. permitted storage temperature TL min.	-35 °C		
Max. permitted storage temperature TL max.	85 °C		

**4.2 Climatic Requirements**

Humidity requirements	humid heat, cyclic; according to DIN EN 60068-2-30, 6 cycle		
Water exposure	None		
Dust requirements	Dust check; according to DIN EN 60068-2-68, 6g/m <sup>2</sup> d, 1 day		
Salt fog requirements	None		

Permitted application area:

The product is for the use in sheltered rooms with limited controlled temperature. Occasionally condensed water is allowed. Direct exposure to water must be avoided. Saline ambient conditions must be avoided.

Pollution degree 2 (according DIN EN 60664-1)

It occurs only non-conductive pollution. Occassionally, temporary conductivity caused by condensation occurs.

### 4.3 Mechanical Requirements

severity level	stationary use		
1	storage / transportation	Random vibration not in use IEC 60068-2-64 Frequency range / ASD  G <sub>RMS</sub> Axes of vibration Test duration	Random vibration 5 - 20 Hz : 1,0 m <sup>2</sup> / s <sup>3</sup> 20 - 500 Hz : - 3 dB / Oct 0,91 G 3 3 x 5 h
	storage / transportation	Bump not in use IEC 60068-2-29 Shock spectrum Acceleration Duration Number of bumps (+X, -X, -Y, +Y, -Z, +Z) Total bumps	Bump half sine 18 G 6 ms 100 in each direction 600
	stationary use	Random vibration in use IEC 60068-2-64 Frequency range / ASD  G <sub>RMS</sub> Axes of vibration Test duration	Random vibration 5 - 20 Hz : 2,0 m <sup>2</sup> / s <sup>3</sup> 20- 150 Hz : - 3 dB / Oct 0,83 G 3 3 x 5 h
	stationary use	Bump in use IEC 60068-2-29 Shock spectrum Acceleration Duration Number of bumps (+X, -X, -Y, +Y, -Z, +Z) Total bumps	Bump half sine 5 G 11 ms 100 in each direction 600

### 4.4 EMC

Kind	Conducted Emission; Voltage; 150 kHz-30 MHz (without PE)
According	DIN EN 55032:2016-02
Check accuracy / Limit	Class B
Result	Below limit Class B

Kind	Radiated Emission; 30 MHz - 1000 MHz (without PE)
According	DIN EN 55032:2016-02
Check accuracy / Limit	Class B
Result	Below limit Class B

<b>Kind</b>	<b>Electrostatic Discharge Immunity Test</b>
Accordinging	DIN EN 61000-4-2:2001-12
Ceck accuracy / Limit	Contact Discharge +/- 4 kV; Air Discharge +/- 8 kV
Result	A: The monitored function operates as designed during and after exposure to a disturbance.

<b>Kind</b>	<b>Electromagnetic Field Immunity Test</b>
Accordinging	DIN EN 61000-4-3:2006-12
Ceck accuracy / Limit	10 V/m; 80 - 1000 MHz; AM; m = 0,8; f = 1 kHz; 1%; t = 3 s
Result	A: The monitored function operates as designed during and after exposure to a disturbance.

<b>Kind</b>	<b>Electrical Fast Transient / Burst Immunity Test</b>
Accordinging	DIN EN 61000-4-4:2005-07
Ceck accuracy / Limit	+/- 2 kV on Power Lines; Coupling: POS, NEG, {PE}, ALL, 5 kHz and 100 kHz; 1 min
Result	A: The monitored function operates as designed during and after exposure to a disturbance.

<b>Kind</b>	<b>Immunity to Conducted Disturbances, Induced by RF-Fields</b>
Accordinging	DIN EN 61000-4-6:2001-12
Ceck accuracy / Limit	10 Vrms; 150 kHz - 80 MHz; AM; m = 0,8; f = 1 kHz; 1%; t = 3 s
Result	A: The monitored function operates as designed during and after exposure to a disturbance.

**5 Safety**

**5.1 Electrical Safety**

Dielectric strength DIN EN 62368 and DIN EN 60335 A.) Type test Measuring conditions: After 48h of storage at 95% R.H. and 25°C. No arcing or breakdown is allowed! All connections together to ground. B.) Routine test Measuring conditions: At indoor climate. No arcing or breakdown is allowed! All connections together to ground.	Not applicable  850 VDC / 1 Sec.	
Isolation resistance Measuring conditions: After 48h of storage at 95% R.H. and 25°C measured with U=500 VDC for 1 min.		
Clearance / creepage distance		
Protection class	III	

**5.2 Approval Tests**

CE	EC Declaration of Conformity	Yes
EAC	Eurasian Conformity	Yes
UL	Underwriters Laboratories	Yes / UL507, Electric Fans E38324
VDE	Association for Electrical, Electronic and Information Technologies	Yes / Approval acc. to EN 60335 (VDE 0700) - Safety for household and similar electrical appliances
CSA	Canadian Standards Association	Yes / CSA audited by UL according to C22.2 No. 113 Fans and Ventilators
CCC	China Compulsory Certification	Not applicable

**6 Reliability**

**6.1 General**

--	--	--

Upon request

The reproduction, distribution and utilization of this document as well as the communication of its contents to others without express authorization is prohibited. Offenders will be held liable for the payment of damages. All rights reserved in the event of the grant of a patent. Utility model or design. Refer to publication number I 52 10401.

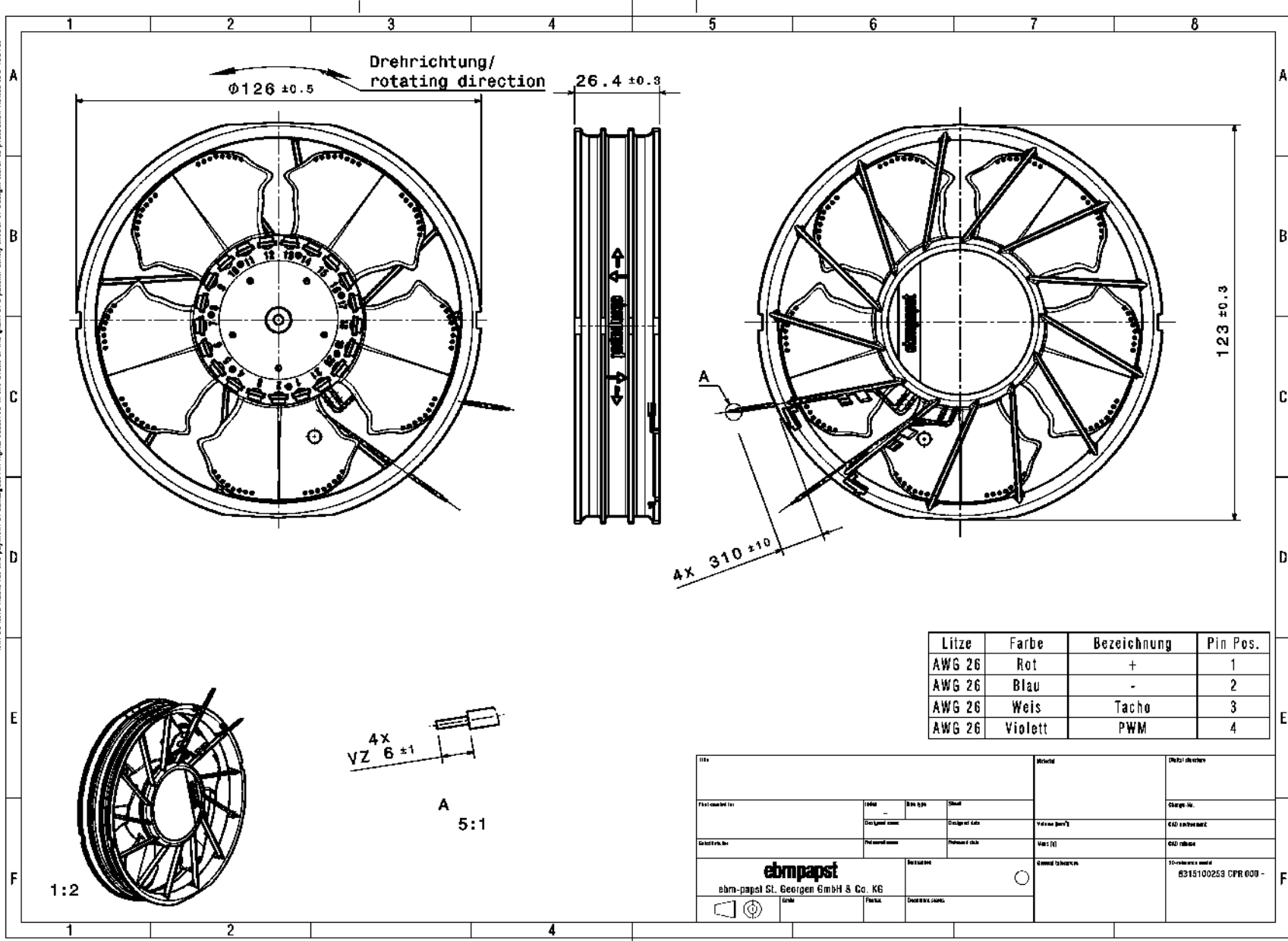

Litze	Farbe	Bezeichnung	Pin Pos.
AWG 26	Rot	+	1
AWG 26	Blau	-	2
AWG 26	Weiss	Tacho	3
AWG 26	Violett	PWM	4

Title			Article		Date / revision	
Part number (1)			Order	Site type	Sheet	Storage No.
Design name			Design date	Version (Rev.)	CAD software	
Customer no.			Project name	Year (Y)	CAD release	
<b>ebmpapst</b>				Drawing No.		Drawing status
ebm-papst St. Georgen GmbH & Co. KG				Drawing scale		3D-references used
Scale				Part no.		8315100253 CPR 000 -