

M12 FEMALE 90° SHIELDED

PUR 8x0,25 shielded GRAY, 5m

M12
Female 90°
8-pole, shielded

Plastic housings with good resistance against chemicals and oils. The resistance to aggressive media should be individually tested for your application. Further details on request. Further cable lengths on request.

[Link to Product](#)**Illustration**

Female

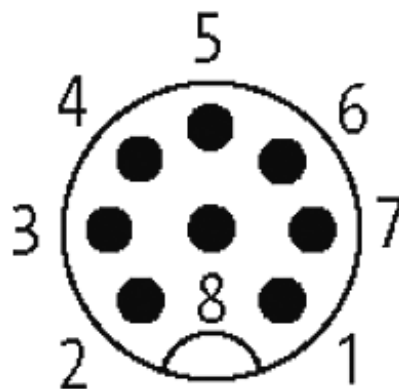

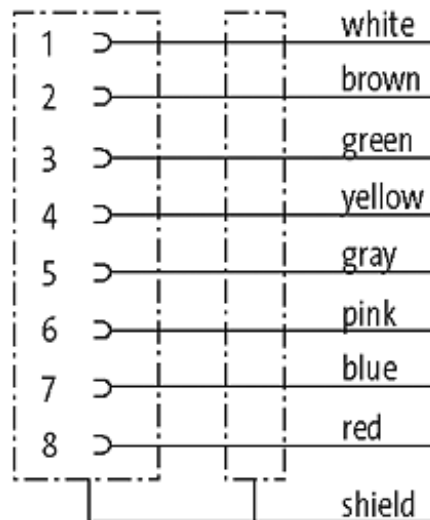
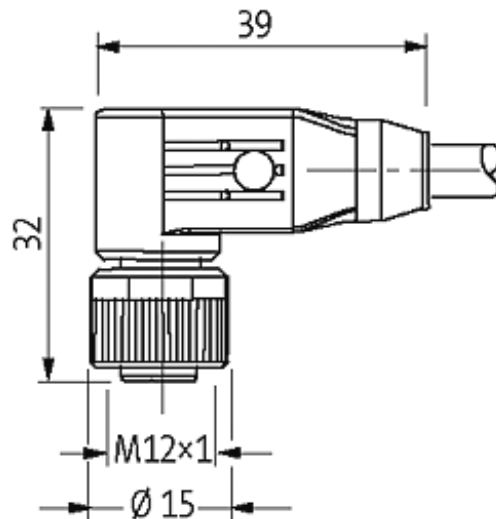

Product may differ from Image

Approvals



Form

17141

Technical Data

Operating voltage	max. 30 V AC/DC
Operating current per contact	max. 2 A
Locking of ports	Screw thread M12 × 1 mm (recommended torque 0.6 Nm) self-securing
Protection	IP67 inserted and tightened (EN 60529)

Cables

Cable number	291
--------------	-----

No./diameter of wires	8 × 0.25 mm ²
Wire isolation	PP (wh, br, gn, ye, gr, pk, bl, rd)
C-track properties	5 Mio.
Torsion	2 Mio. ± 30°/m
Jacket Color	gray
Shore hardness outer jacket	90 ± 5A
Material (jacket)	PUR, suitable for C-tracks
Outer diameter	approx. 7.0 mm
Bend radius (fixed)	5 × outer Ø
Bend radius (moving)	10 × outer Ø
Temperature range (fixed)	-40...+80 °C
Temperature range (mobile)	-25...+80 °C
Shielded	yes

General data

Temperature range -25...+85 °C, depending on cable quality

Commercial data

country of origin	DE
customs tariff number	85444290
minimum order quantity	1