

Thermistor motor prot. relay Compact evaluation unit  
 17.5 mm enclosure Screw terminals 1 CO contact US =  
 24 V AC/DC Auto RESET Suitable for bimetal switches  
 Supply = output voltage 1 LED (READY)



Figure similar

Article number		
<b>Product brand name</b>		SIRIUS
<b>Product category</b>		SIRIUS 3RN2 thermistor motor protection
<b>Product designation</b>		Thermistor motor protection relay
<b>Product type designation</b>		3RN2

General technical data		
<b>Display version LED</b>		Yes
<b>Power loss [W] for rated value of the current</b>		
• at AC in hot operating state	W	0.5
• at DC in hot operating state	W	0.3
<b>Insulation voltage</b>		
• for overvoltage category III according to IEC 60664		
— with degree of pollution 3 rated value	V	300
<b>Degree of pollution</b>		3
<b>Surge voltage resistance rated value</b>	kV	4
<b>Protection class IP</b>		IP20
<b>Shock resistance</b>		

<ul style="list-style-type: none"> <li>• acc. to IEC 60068-2-27</li> </ul>		11g / 15 ms
<b>Vibration resistance</b>		
<ul style="list-style-type: none"> <li>• acc. to IEC 60068-2-6</li> </ul>		10 ... 55 Hz: 0.35 mm
<b>Mechanical service life (switching cycles)</b>		
<ul style="list-style-type: none"> <li>• typical</li> </ul>		10 000 000
<b>Electrical endurance (switching cycles)</b>		
<ul style="list-style-type: none"> <li>• at AC-15 at 230 V typical</li> </ul>		100 000
<b>Thermal current of the switching element with contacts maximum</b>	A	5
<b>Equipment marking</b>		
<ul style="list-style-type: none"> <li>• acc. to DIN 40719 extended according to IEC 204-2 acc. to IEC 750</li> </ul>		K
<ul style="list-style-type: none"> <li>• acc. to DIN EN 61346-2</li> </ul>		K
<ul style="list-style-type: none"> <li>• acc. to DIN EN 81346-2</li> </ul>		K

Control circuit/ Control		
<b>Type of voltage of the control supply voltage</b>		AC/DC
<b>Control supply voltage at AC</b>		
<ul style="list-style-type: none"> <li>• at 50 Hz rated value</li> </ul>	V	24 ... 24
<ul style="list-style-type: none"> <li>• at 60 Hz rated value</li> </ul>	V	24 ... 24
<b>Control supply voltage at DC</b>		
<ul style="list-style-type: none"> <li>• rated value</li> </ul>	V	24 ... 24
<b>Operating range factor control supply voltage rated value at DC</b>		
<ul style="list-style-type: none"> <li>• initial value</li> </ul>		0.85
<ul style="list-style-type: none"> <li>• Full-scale value</li> </ul>		1.1
<b>Operating range factor control supply voltage rated value at AC at 50 Hz</b>		
<ul style="list-style-type: none"> <li>• initial value</li> </ul>		0.85
<ul style="list-style-type: none"> <li>• Full-scale value</li> </ul>		1.1
<b>Operating range factor control supply voltage rated value at AC at 60 Hz</b>		
<ul style="list-style-type: none"> <li>• initial value</li> </ul>		0.85
<ul style="list-style-type: none"> <li>• Full-scale value</li> </ul>		1.1
<b>Inrush current peak</b>		
<ul style="list-style-type: none"> <li>• at 24 V</li> </ul>	A	1.8
<b>Duration of inrush current peak</b>		
<ul style="list-style-type: none"> <li>• at 24 V</li> </ul>	ms	2

Measuring circuit		
<b>Buffering time in the event of power failure minimum</b>	ms	40

Precision		
<b>Relative metering precision</b>	%	9

Auxiliary circuit		
<b>Material of switching contacts</b>		AgSnO <sub>2</sub>
<b>Number of NC contacts</b>		0
• for auxiliary contacts		
<b>Number of NO contacts</b>		0
• for auxiliary contacts		
<b>Number of CO contacts</b>		1
• for auxiliary contacts		
<b>Operating current of auxiliary contacts at DC-13</b>		
• at 24 V	A	1
• at 125 V	A	0.2
• at 250 V	A	0.1

Main circuit		
<b>Operating frequency rated value</b>	Hz	50 ... 60

Outputs		
<b>Ampacity of the output relay at AC-15</b>		
• at 250 V at 50/60 Hz	A	3
<b>Ampacity of the output relay at DC-13</b>		
• at 24 V	A	1
• at 125 V	A	0.2
<b>Continuous current of the DIAZED fuse link of the output relay</b>	A	6

Electromagnetic compatibility		
<b>Conducted interference</b>		
• due to burst acc. to IEC 61000-4-4		2 kV (power ports) / 1 kV (signal ports)
• due to conductor-earth surge acc. to IEC 61000-4-5		2 kV (line to ground)
• due to conductor-conductor surge acc. to IEC 61000-4-5		1 kV (line to line)
<b>Electrostatic discharge acc. to IEC 61000-4-2</b>		6 kV contact discharge / 8 kV air discharge

Galvanic isolation		
<b>Design of the electrical isolation</b>		No separation
<b>Galvanic isolation</b>		
• between entrance and outlet		No
• between the voltage supply and other circuits		No

Connections/Terminals		
<b>Product function</b>		
• removable terminal for auxiliary and control circuit		Yes
<b>Type of electrical connection</b>		screw-type terminals
<b>Type of connectable conductor cross-sections</b>		

<ul style="list-style-type: none"> <li>• solid</li> <li>• finely stranded with core end processing</li> <li>• at AWG conductors solid</li> </ul>		1x (0.5 ... 4.0 mm <sup>2</sup> ), 2x (0.5 ... 2.5 mm <sup>2</sup> ) 1x (0.5 ... 4 mm <sup>2</sup> ), 2x (0.5 ... 1.5 mm <sup>2</sup> ) 1x (20 ... 12), 2x (20 ... 14)
<b>Connectable conductor cross-section</b>		
<ul style="list-style-type: none"> <li>• solid</li> <li>• finely stranded with core end processing</li> </ul>	mm <sup>2</sup>	0.5 ... 4
	mm <sup>2</sup>	0.5 ... 4
<b>AWG number as coded connectable conductor cross section</b>		
<ul style="list-style-type: none"> <li>• solid</li> <li>• stranded</li> </ul>		20 ... 12
		20 ... 12
<b>Tightening torque</b>		
<ul style="list-style-type: none"> <li>• with screw-type terminals</li> </ul>	N·m	0.6 ... 0.8

### Installation/ mounting/ dimensions







<b>Mounting position</b>		any
<b>Mounting type</b>		screw and snap-on mounting onto 35 mm standard mounting rail
<b>Height</b>	mm	100
<b>Width</b>	mm	17.5
<b>Depth</b>	mm	90
<b>Required spacing</b>		
<ul style="list-style-type: none"> <li>• with side-by-side mounting           <ul style="list-style-type: none"> <li>— forwards</li> <li>— Backwards</li> <li>— upwards</li> <li>— downwards</li> <li>— at the side</li> </ul> </li> <li>• for grounded parts           <ul style="list-style-type: none"> <li>— forwards</li> <li>— Backwards</li> <li>— upwards</li> <li>— at the side</li> <li>— downwards</li> </ul> </li> <li>• for live parts           <ul style="list-style-type: none"> <li>— forwards</li> <li>— Backwards</li> <li>— upwards</li> <li>— downwards</li> <li>— at the side</li> </ul> </li> </ul>	mm	0
	mm	0
	mm	0
	mm	0
	mm	0
	mm	0
	mm	0
	mm	0
	mm	0
	mm	0
	mm	0
	mm	0
	mm	0
	mm	0
	mm	0

### Ambient conditions

<b>Installation altitude at height above sea level</b>		
<ul style="list-style-type: none"> <li>• maximum</li> </ul>	m	2 000

<b>Ambient temperature</b>		
• during operation	°C	-25 ... +60
• during storage	°C	-40 ... +85
• during transport	°C	-40 ... +85
<b>Relative humidity</b>		
• during operation	%	70

#### Certificates/approvals

<b>General Product Approval</b>	<b>EMC</b>	<b>For use in hazardous locations</b>	<b>Declaration of Conformity</b>
 CSA	 UL	 EAC	 C-Tick
 PTB	 EG-Konf.		

<b>Test Certificates</b>	<b>Marine / Shipping</b>	<b>other</b>
<a href="#">Type Test Certificates/Test Report</a>	 LRS	 PRS
	 DNV-GL DNVGL.COM/AF	<a href="#">Confirmation</a>
		<a href="#">Environmental Confirmations</a>

#### Further information

##### Information- and Downloadcenter (Catalogs, Brochures,...)

<http://www.siemens.com/industrial-controls/catalogs>

##### Industry Mall (Online ordering system)

<https://mall.industry.siemens.com/mall/en/en/Catalog/product?mlfb=3RN2000-1AA30>

##### Cax online generator

<http://support.automation.siemens.com/WW/CAXorder/default.aspx?lang=en&mlfb=3RN2000-1AA30>

##### Service&Support (Manuals, Certificates, Characteristics, FAQs,...)

<https://support.industry.siemens.com/cs/ww/en/ps/3RN2000-1AA30>

##### Image database (product images, 2D dimension drawings, 3D models, device circuit diagrams, EPLAN macros, ...)

[http://www.automation.siemens.com/bilddb/cax\\_de.aspx?mlfb=3RN2000-1AA30&lang=en](http://www.automation.siemens.com/bilddb/cax_de.aspx?mlfb=3RN2000-1AA30&lang=en)

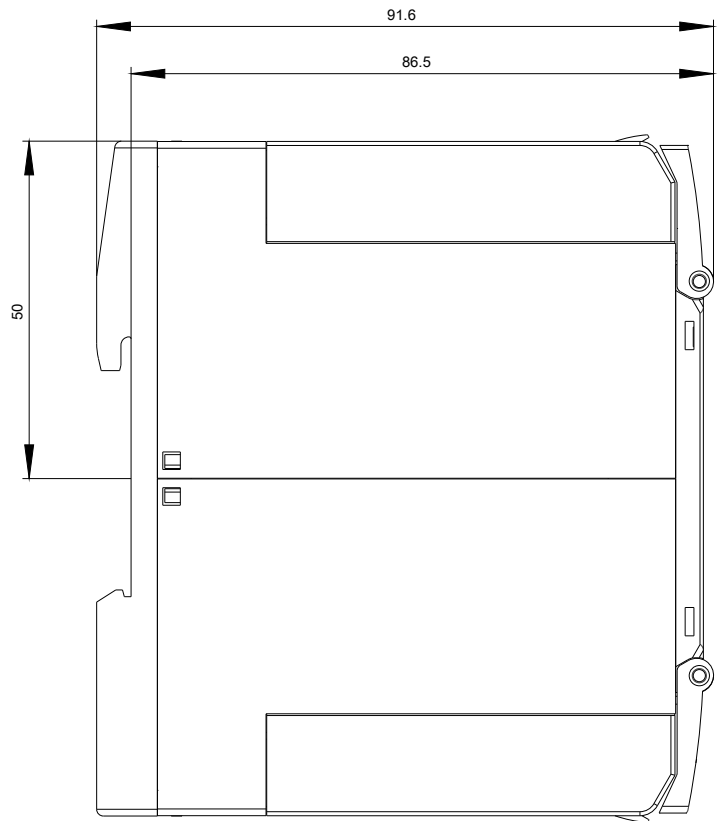
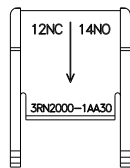
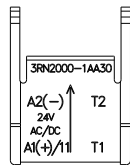
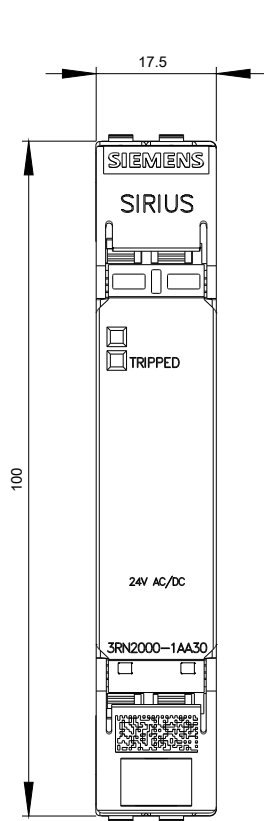

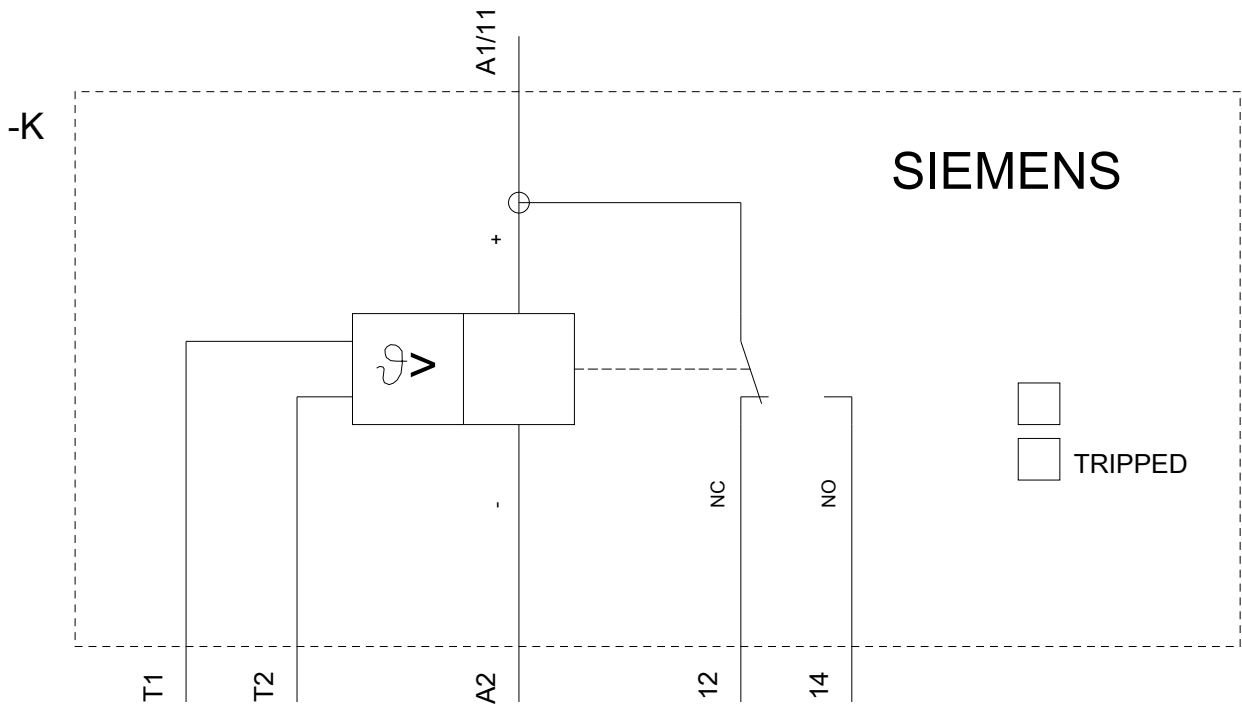

last modified:

09/25/2017