

TACT & KEY SWITCHES

TACT & KEY SWITCH SELECTION GUIDE: This catalog contains an extensive variety of tact & key switches with many options. To facilitate easy selection of the desired switch for your application, this guide lists the various Series with a brief description.

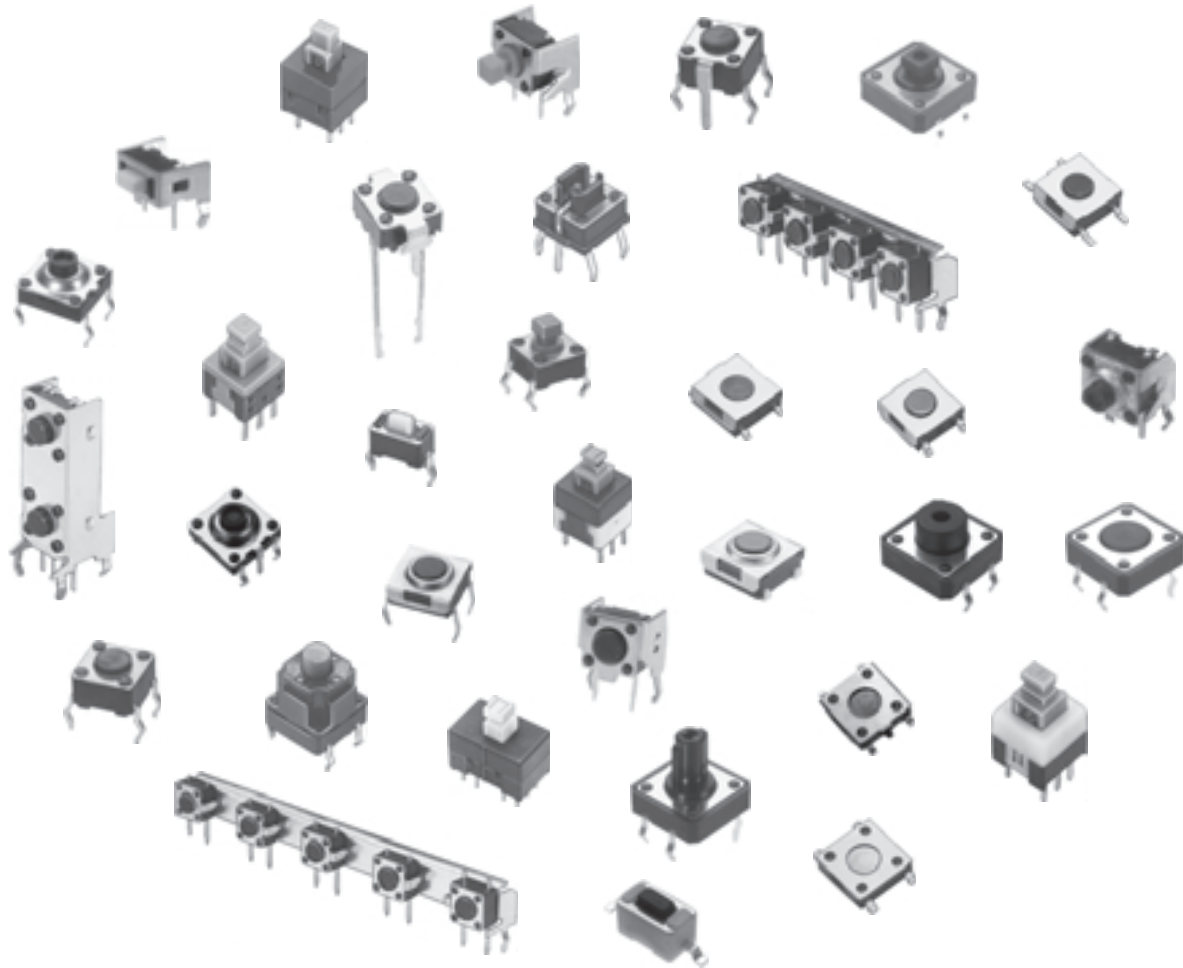

SPECIFICATIONS SUBJECT TO CHANGE WITHOUT NOTICE.

F

SERIES	DESCRIPTION	PAGE(S)
MJTP	12mm Square tact switches, through-hole mounting, single pole-single throw momentary action	F1-F2
MJTP	6mm Square tact switches, through-hole mounting, single pole-single throw momentary action	F3-F7
MJTP	6mm & 4mm Square tact switches, surface mounting, single pole-single throw momentary action	F8-F13
MHPS	Miniature square key switches, through-hole mounting, double pole-double throw, momentary & maintained action	F14-F15
MTP	Miniature square key switches, through-hole mounting, single pole-single throw momentary action, totally sealed	F16

MJTP SERIES - 12 MM SQUARE TACT SWITCHES

FEATURES

- SPST momentary action.
- Excellent tactile feed-back (Snap dome).
- Long operating life for high reliability.
- Molded-in terminals minimize wicking of flux or solder.
- Flush, round, keyed or square actuator.
- Thru-hole mounting.

MATERIALS

Case: PBT, color black.
 Actuator: P.O.M. thermoplastic, color black.
 Cover: Stainless steel.
 Terminals: Silver plated brass.
 Shorting Contact: Silver plated phosphor bronze.



MJTP1212

MJTP1212A

MJTP1212B

MJTP1212C

GENERAL SPECIFICATIONS

ELECTRICALS

Contact rating:	50 mA @ 12 VDC
Insulation resistance:	100 megohms min. (500 VDC)
Dielectric withstanding voltage:	250 VAC for 1 minute
Contact resistance:	100 milliohms max.
Electrical Life:	100,000 cycles min. (1,000,000 cycles available - consult factory)
Contact bounce:	less than 5 msec.

MECHANICALS, THERMALS, ENVIRONMENTALS

Plunger travel:	.012" ± .006" (0.30 ± 0.15 mm)
Actuation force:	160 grams ± 50 grams
Operating temperature range:	-20°C to +70°C
Storage temperature range:	-30°C to +80°C for 96 hours
Shock resistance:	30G (peak value) for 11 millisecond. per Method 213B, MIL-STD-202F (3 times each on 6 sides).
Vibration resistance:	10-55-10 Hz. for 1 minute in X, Y and Z planes per Method 201A, MIL-STD-202F (2 hours in each direction).

SOLDERING

Wave soldering:	260°C max. for 5 seconds max..
Hand soldering:	30 watt iron max. controlled at 320°C for approx. 2 seconds
Solvent washing:	Non-washable.

MJTP1212

Flush actuator

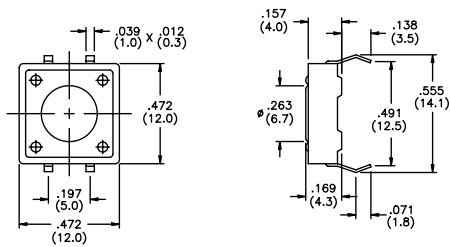

MJTP1212A

Round actuator

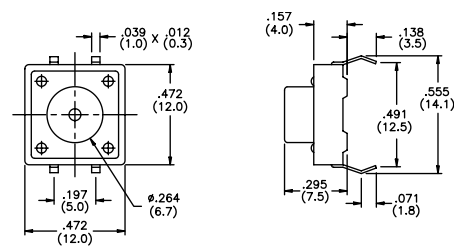

SPECIFICATIONS SUBJECT TO CHANGE WITHOUT NOTICE.

F

MJTP1212B

Round keyed actuator

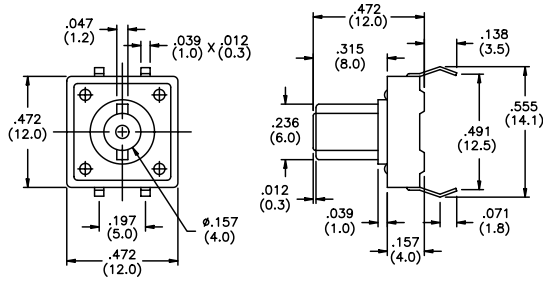
**MJTP1212C**

Square actuator

Caps available - see below

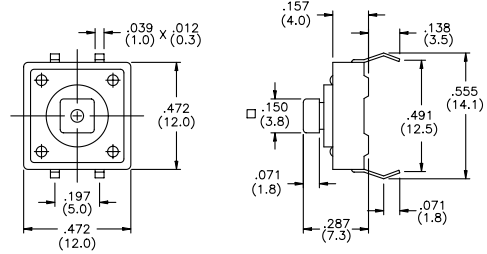
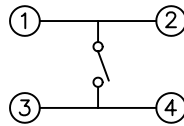
**SCHEMATIC****PRINTED CIRCUIT BOARD LAYOUT**

Layout Tolerances;
Linear: $\pm .004"$ ($\pm 0,1\text{mm}$)
Holes: $\pm .002"$ ($\pm 0,05\text{mm}$)

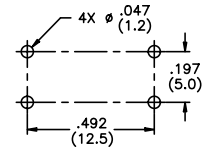
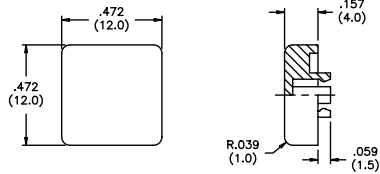
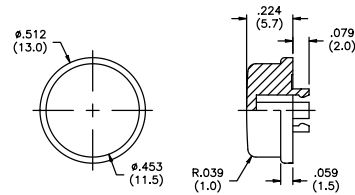
**CAPS (for MJTP1212C only)****MJ121** Square cap**MJ122** Round cap

SPECIFICATIONS SUBJECT TO CHANGE WITHOUT NOTICE.

F

Note - add digit from table to cap part numbers above for color.
Example - **MJ1212** indicates square black cap.

No.	Color
1	blue
2	black
3	green
5	yellow
6	red
7	ivory

MJTP SERIES 6MM THRU-HOLE MTG. TACT SWITCHES

FEATURES

- Numerous single pole-single throw momentary configurations.
- Excellent tactile feed-back (Snap dome).
- Ultra-compact size.
- Long operating life for high reliability.
- Molded-in terminals minimize wicking of flux or solder.

MATERIALS

Case: Thermoplastic, color black.
 Actuator: Thermoplastic, color black unless otherwise specified.
 Cover/Bracket: PET film, tin plated brass or stainless steel.
 Terminals: Silver plated brass.
 Shorting Contact: Phosphor bronze or stainless steel with silver plating.
 L.E.D. rating: Forward voltage- 2.1 V (3.0 V Max.). Cont. fwd. current 20mA max. @ 25°C.

Gold plating available on contacts & terminals - consult factory.

SPECIFICATIONS SUBJECT TO CHANGE WITHOUT NOTICE.

GENERAL SPECIFICATIONS

ELECTRICALS

Contact rating: 50 mA @ 12 VDC
 Insulation resistance: 100 megohms min. (100 VDC)
 Dielectric withstanding voltage: 250 VAC for 1 minute
 Contact resistance: 100 milliohms max. @ 5 VDC, 10 mA
 Electrical life: 100,000 cycles min. (except models MJTP1243 & 1250- 50,000 cycles)
 1,000,000 cycles available - consult factory
 Contact bounce: less than 10 msec.

MECHANICALS, THERMALS, ENVIRONMENTALS

Plunger travel: .010" + .008", - .004" (0,25 +0,2, -0,1 mm)
 Actuation force: 160 grams ±30 grams
 Operating temperature range: -20°C to +70°C
 Storage temperature range: -30°C to +80°C for 96 hours
 Shock resistance: 30G per method 213, MIL-STD-202
 Vibration resistance: passes method 201, MIL-STD-202

SOLDERING (note - non-washable except for models indicated 'process compatible' below).

IR reflow soldering: 240°C max. for 20 seconds max.
 Wave soldering: 255°C max. for 5 seconds max.
 Hand soldering: 320°C max. for 3.5 seconds max. (40 watt iron max.)

MJTP1105T

Right angle, grounding

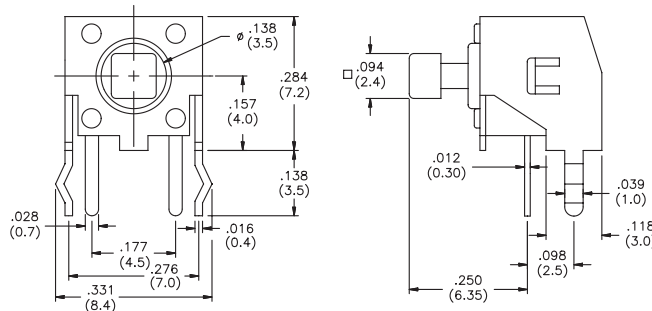

Caps available - see end of section.
Bulk packaged.

MJTP1109

Process compatible, grounding

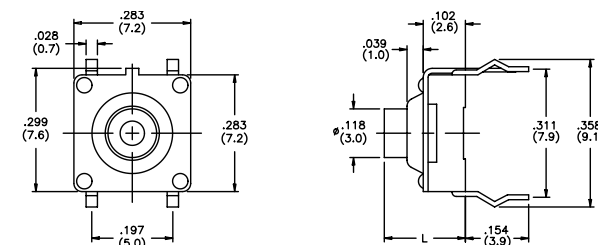

Model No.	Dim. L (In./mm)
MJTP1109	.197 (5.0)
MJTP1109A	.354 (9.0)
MJTP1109B	.512 (13.0)

Bulk packaged.

MJTP1117
Right angle, grounding



New!

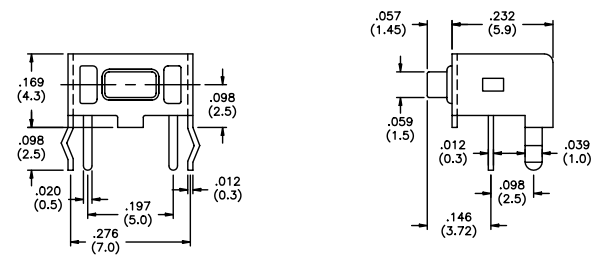

Bulk packaged.

MJTP1119
Process compatible



New!

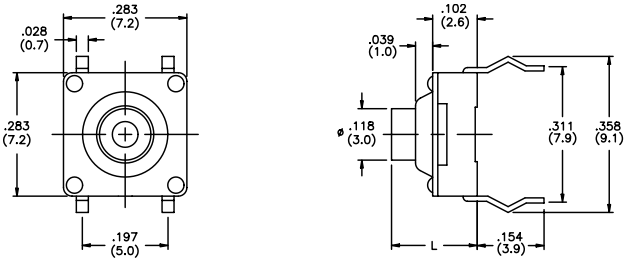

Model No.	Dim. L (in./mm)
MJTP1119	.197 (5.0)
MJTP1119A	.354 (9.0)
MJTP1119B	.512 (13.0)

Bulk packaged.

F

MJTP1129
Right angle, grounding, process compatible

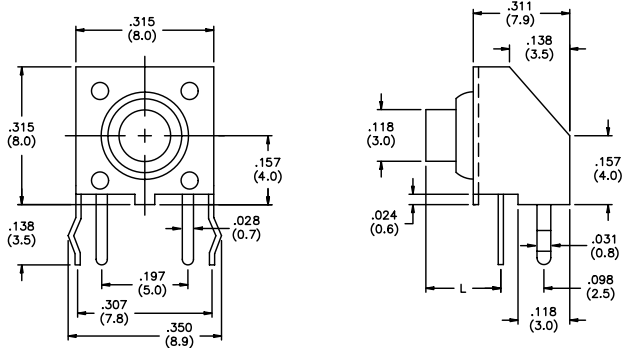
Model No.	Dim. L (in./mm)
MJTP1129	.171 (4.35)
MJTP1129A	.329 (8.35)
MJTP1129B	.486 (12.35)

Bulk packaged.

MJTP1141
Long terminals

Model No.	Dim. L (in./mm)
MJTP1141	.169 (4.3)
MJTP1141A	.197 (5.0)

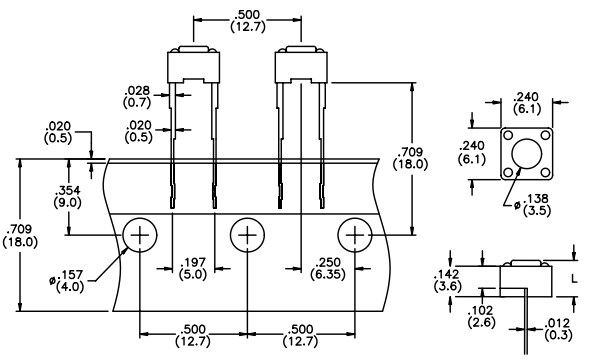
Packaged on tape. Note: other models available with this tape packaging - consult factory.

MJTP1144
Long terminals, grounding



New!

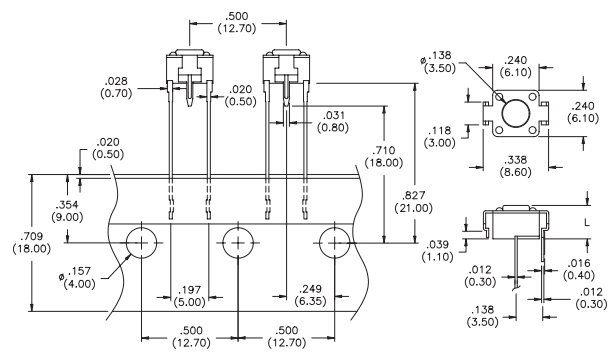

Model No.	Dim. L (in./mm)
MJTP1144	.169 (4.3)
MJTP1144A	.197 (5.00)

Caps available - see end of section. Bulk packaged.

MJTP1145
Right angle, grounding



New!

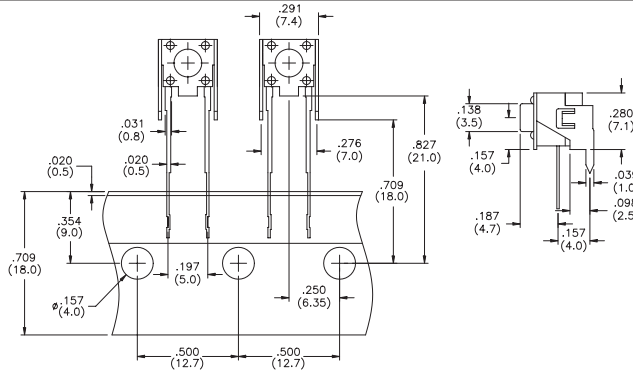

Model No.	Actuator Color
MJTP1145	Black
MJTP1145W	Gray

Bulk packaged.

MJTP1193
With L.E.D.



New!

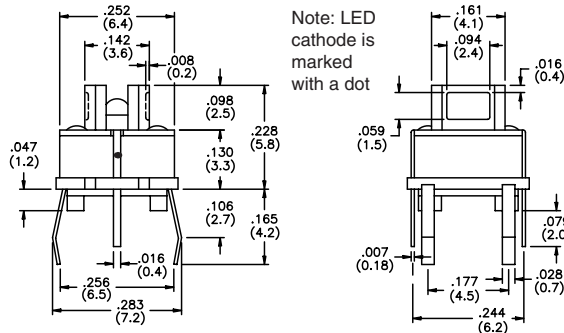

Model No.	L.E.D. Color
MJTP1193	No L.E.D.
MJTP1193B	Red
MJTP1193S	Yellow
MJTP1193C	Green

Caps available with lens - see end of section.
Bulk packaged.

MJTP1230

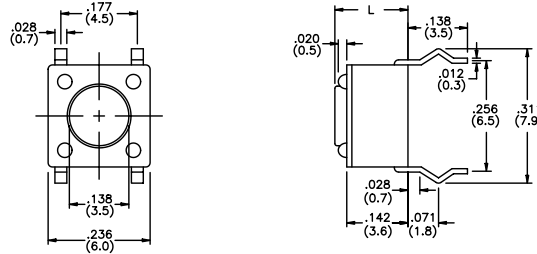

Model No.	Dim. L (in./mm)
MJTP1230	.170 (4,3)
MJTP1230A	.197 (5,0)
MJTP1230B	.374 (9,5)
MJTP1230C	.315 (8,0)
MJTP1230D	.512 (13,0)
MJTP1230E	.287 (7,3)
MJTP1230F	.335 (8,5)
MJTP1230G	.275 (7,0)

Bulk packaged.

MJTP1232
Grounding

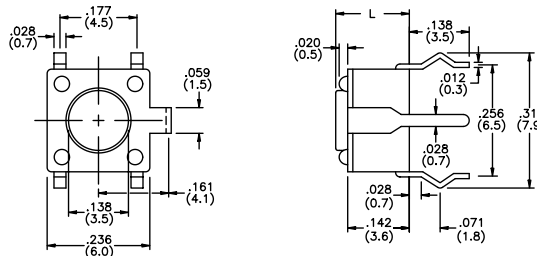

Model No.	Dim. L (in./mm)
MJTP1232	.170 (4,3)
MJTP1232A	.197 (5,0)
MJTP1232B	.374 (9,5)
MJTP1232C	.315 (8,0)
MJTP1232D	.512 (13,0)
MJTP1232E	.287 (7,3)
MJTP1232F	.335 (8,5)
MJTP1232G	.275 (7,0)

Bulk packaged.

MJTP1234

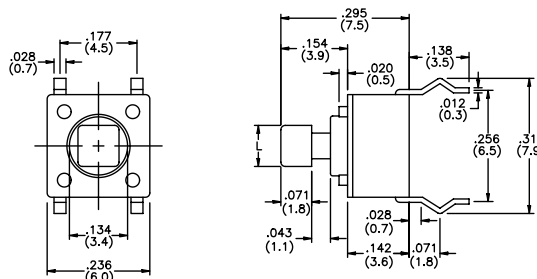

Model No.	Dim. L (in./mm)
MJTP1234	.094 (2,4)
MJTP1234A	.110 (2,8)

Caps available - see end of section.
Bulk packaged.

F

MJTP1236

Right angle, grounding

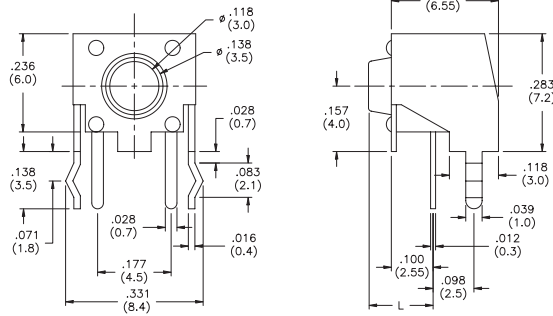

Model No.	Dim. L (in./mm)
MJTP1236	.124 (3,1)
MJTP1236A	.152 (3,9)
MJTP1236B	.329 (8,4)
MJTP1236C	.270 (6,9)
MJTP1236D	.466 (11,9)
MJTP1236E	.244 (6,2)
MJTP1236F	.289 (7,3)
MJTP1236G	.230 (5,8)

Bulk packaged.

MJTP1243 & MJTP1250

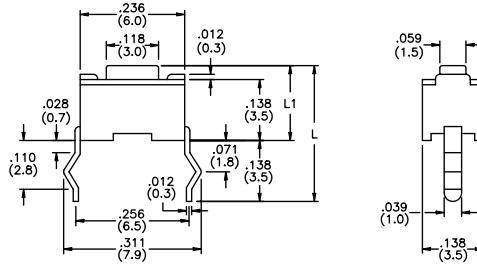

Model No.	Dim. L1 (in./mm)	Dim. L (in./mm)
MJTP1243	.169 (4,3)	.307 (7,8)
MJTP1250	.197 (5,0)	.335 (8,5)

Bulk packaged.

MJTP2205

2 switch vertical gang assembly, black actuators

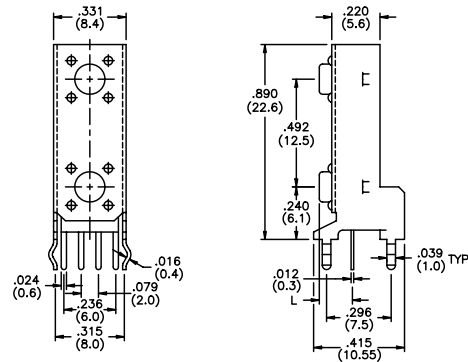

Model No.	Dim. L (in./mm)
MJTP2205	.124 (3,15)
MJTP2205A	.152 (3,85)
MJTP2205B	.329 (8,35)
MJTP2205C	.270 (6,85)
MJTP2205D	.466 (11,85)
MJTP2205E	.242 (6,15)

Bulk packaged.

MJTP4102

4 switch horizontal gang assembly, black actuators

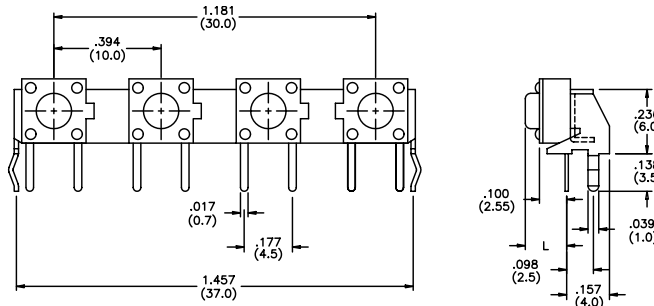

Model No.	Dim. L (in./mm)
MJTP4102	.125 (3,2)
MJTP4102A	.152 (3,85)
MJTP4102B	.329 (8,35)

Bulk packaged.

MJTP5302

5 switch horizontal gang assembly, black actuators

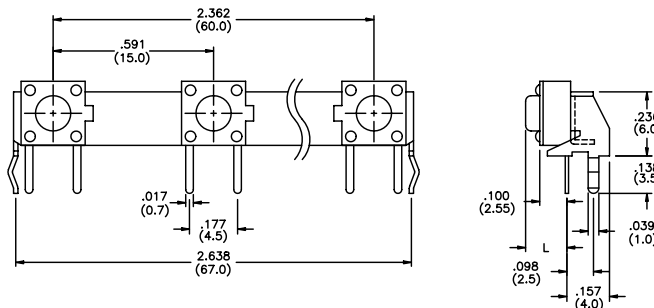

Model No.	Dim. L (in./mm)
MJTP5302	.125 (3,2)
MJTP5302A	.152 (3,85)
MJTP5302B	.329 (8,35)

Bulk packaged.

SPECIFICATIONS SUBJECT TO CHANGE WITHOUT NOTICE.

F

SPECIFICATIONS SUBJECT TO CHANGE WITHOUT NOTICE.

MJTPSHW
Process compatible

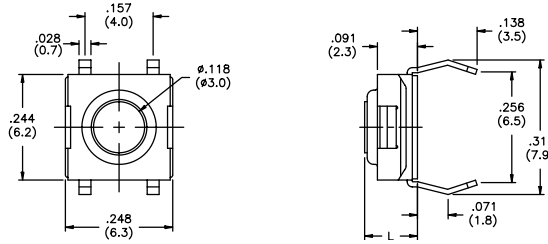

Model No.	Dim. L (in./mm)
MJTPSHW	.122 (3,1)
MJTPSHWA	.091 (2,3)
MJTPSHWB	.146 (3,7)

Bulk packaged.

CAPS (for MJTP1105T and MJTP1234 only)

CAPS (for MJTP1193 only)

New!

CAP COLORS

MJ61 Square cap

MJ62 Round cap

MJ3 Square cap (w/clear lens in center for LED illumination)

Note - add digit from table to cap part number for color.
Example - **MJ612** indicates square black cap.

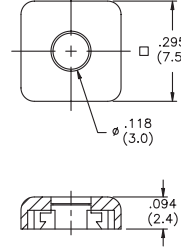
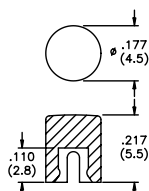
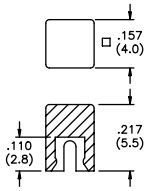

No.	Color
1	blue
2	black
3	green
5	yellow
6	red
7	ivory

SCHEMATICS

- MJTP1109
- MJTP1119
- MJTP1193
- MJTP1230
- MJTP1232

- MJTP1234
- MJTP2205
- MJTP4102
- MJTP5302
- MJTPSHW

Note: LED is for MJTP1193 only.

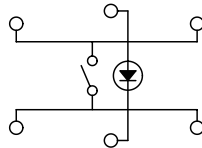

- MJTP1105
- MJTP1117
- MJTP1129
- MJTP1141
- MJTP1144
- MJTP1145

- MJTP1236
- MJTP1243
- MJTP1250
- MJTP2205
- MJTP4102
- MJTP5302

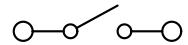

F

PRINTED CIRCUIT BOARD LAYOUTS

Layout tolerances; Linear: ± .004" (± 0,1MM) Holes: ± .002" (± 0,05MM)

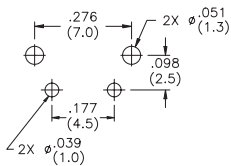

MJTP1105T

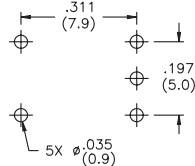

MJTP1109

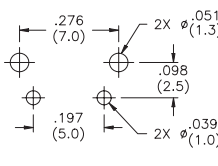

MJTP1117

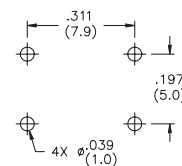

MJTP1119

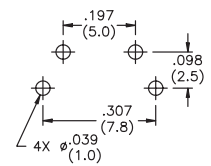

MJTP1129

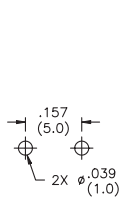

MJTP1141, 44 & 45

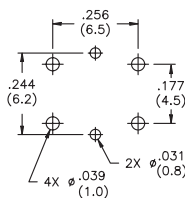

MJTP1193

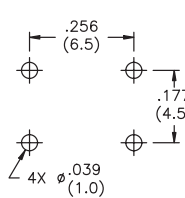

MJTP1230

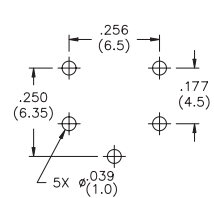

MJTP1232

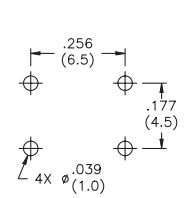

MJTP1234

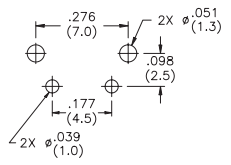

MJTP1236

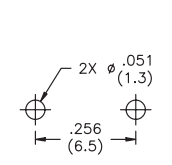

MJTP1243

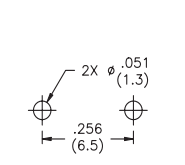

MJTP1250

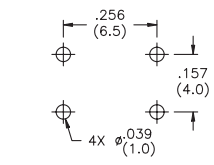

MJTPSHW

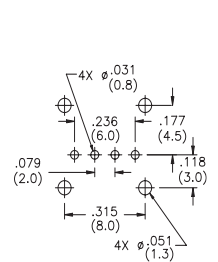

MJTP2205

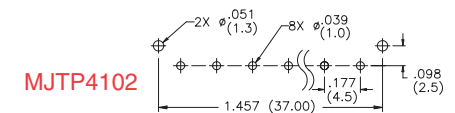

MJTP4102

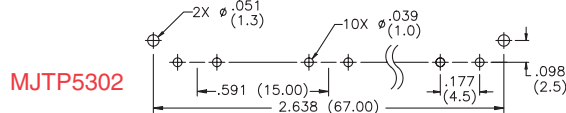

MJTP5302

MJTP SERIES 6MM & 4MM SMD TACT SWITCHES

FEATURES

- Numerous single pole-single throw momentary configurations.
- Excellent tactile feed-back (Snap dome).
- Ultra-compact size.
- Long operating life for high reliability.
- Molded-in terminals minimize wicking of flux or solder.

MATERIALS

Gold plating available on contacts & terminals
- consult factory.

Case: High temperature 4/6 nylon.
 Actuator: High temperature 4/6 nylon.
 Cover/Bracket: PET film, tin plated brass or stainless steel.
 Terminals: Silver plated brass.
 Shorting Contact: Phosphor bronze or stainless steel with silver plating.
 L.E.D. rating: Forward voltage- 2.1 V (3.0 V Max.). Cont. fwd. current 20mA max. @ 25°C.

GENERAL SPECIFICATIONS

ELECTRICALS

Contact rating: 50 mA @ 12 VDC
 Insulation resistance: 100 megohms min. (100 VDC)
 Dielectric withstanding voltage: 250 VAC for 1 minute
 Contact resistance: 100 milliohms max. @ 5 VDC, 10 mA
 Electrical life: 100,000 cycles min. (1,000,000 cycles available - consult factory)
 Contact bounce: less than 10 msec.

MECHANICALS, THERMALS, ENVIRONMENTALS

Plunger travel: .010" + .008", - .004" (0,25 +0,2, -0,1 mm)
 Actuation force: 160 grams ±30 grams
 Operating temperature range: -20°C to +70°C
 Storage temperature range: -30°C to +80°C for 96 hours
 Shock resistance: 30G per method 213, MIL-STD-202
 Vibration resistance: passes method 201, MIL-STD-202

SOLDERING (note - non-washable except for models indicated as 'process compatible').

IR reflow soldering: 240°C max. for 20 seconds max.
 Wave soldering: 255°C max. for 5 seconds max.
 Hand soldering: 320°C max. for 3.5 seconds max. (40 watt iron max.)

SPECIFICATIONS SUBJECT TO CHANGE WITHOUT NOTICE.

F

MJTP1106S

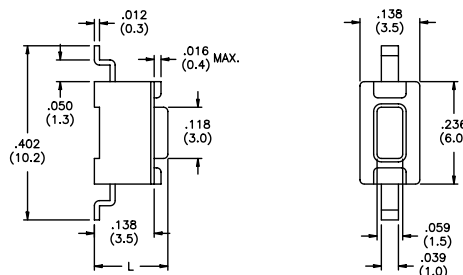

Model No.	Dim. L (in./mm)
MJTP1106S	.169 (4,3)
MJTP1106SA	.197 (5,0)

Bulk packaged.

MJTP1106STR & MJTP1106SATR

Same as above, except supplied on tape and reel as shown.

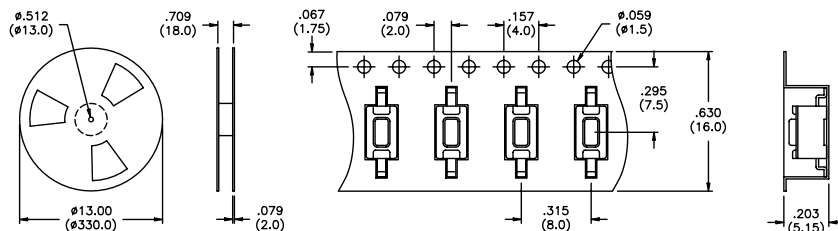

Tape & reel packaging - quantity 2200 per reel.

SPECIFICATIONS SUBJECT TO CHANGE WITHOUT NOTICE.

MJTP1122
Grounding

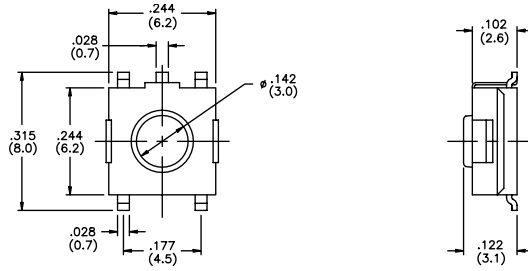

Bulk packaged.

MJTP1122A
Grounding

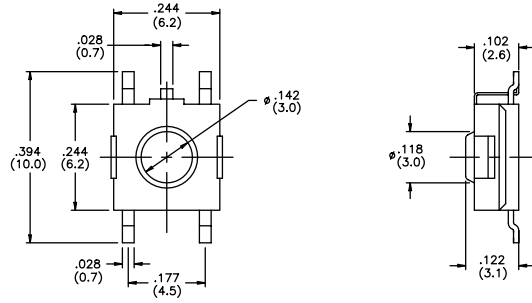

Bulk packaged.

MJTP1122B

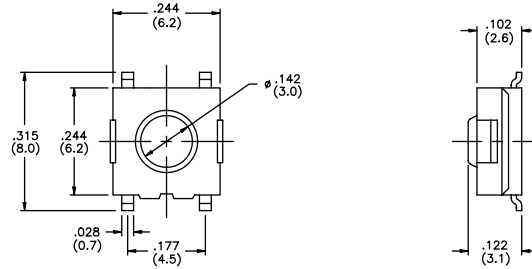

Bulk packaged.

MJTP1122TR & MJTP1122BTR
Same as above, except supplied on tape & reel as shown.
Note - MJTP1122A not available on tape & reel.

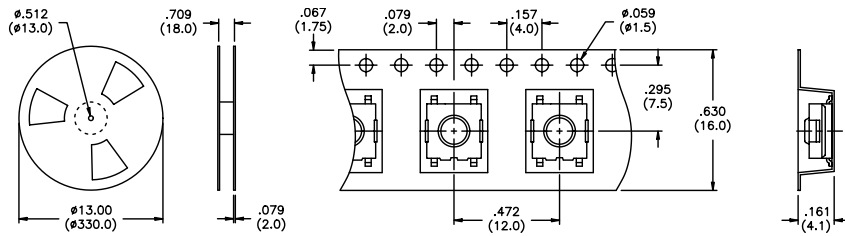

Tape & reel packaging - quantity 1500 per reel.

MJTP1125A
Grounding

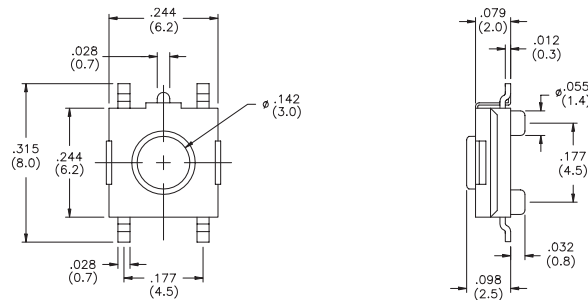

Bulk packaged.

New!

F

MJTP1125B



New!

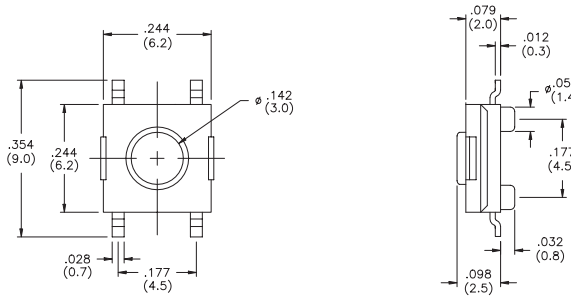

Bulk packaged.

MJTP1137

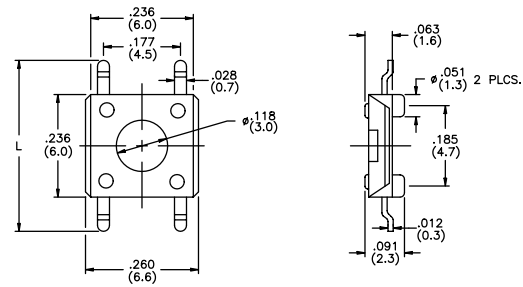



Model No.	Dim. L (in./mm)
MJTP1137	.315 (8,0)
MJTP1137A	.394 (10,0)

Bulk packaged.

F

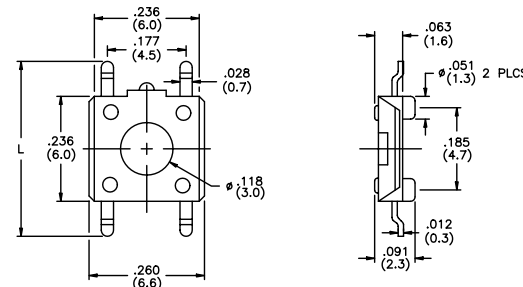
MJTP1137E
Grounding

Model No.	Dim. L (in./mm)
MJTP1137E	.315 (8,0)
MJTP1137AE	.394 (10,0)

Bulk packaged.

MJTP1125ATR.
MJTP1125BTR.
MJTP1137TR &
MJTP1137ETR
Same as above, except supplied on tape & reel as shown.

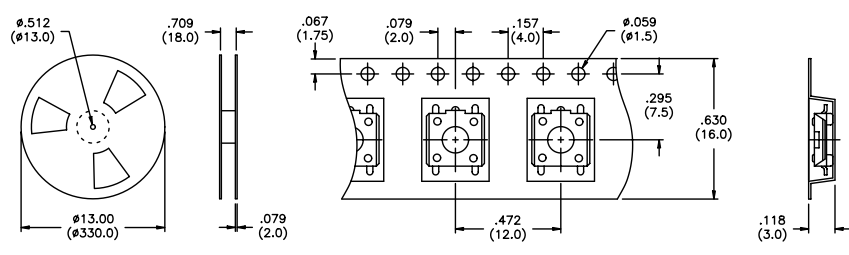

Tape & reel packaging - minimum quantity 2200 per reel.

MJTP1138

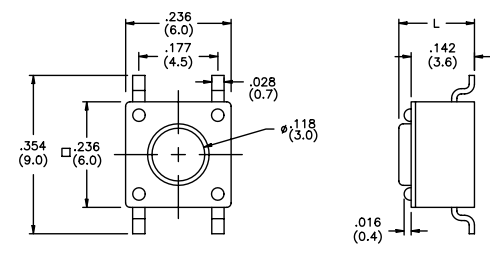



Model No.	Dim. L (in./mm)
MJTP1138	.170 (4,3)
MJTP1138A	.197 (5,0)
MJTP1138B	.374 (9,5)
MJTP1138C	.315 (8,0)
MJTP1138E	.287 (7,3)
MJTP1138F	.335 (8,5)
MJTP1138G	.275 (7,0)

Models MJTP1138 & MJTP1138A bulk packaged. Other models supplied in tubes (90 pcs.).

SPECIFICATIONS SUBJECT TO CHANGE WITHOUT NOTICE.

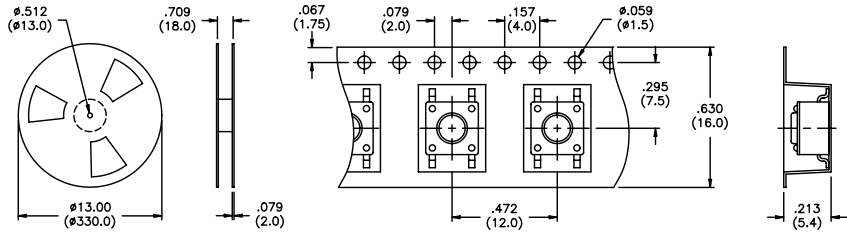
MJTP1138TR & MJTP1138ATR
Same as above except supplied on tape & reel as shown.



Tape & reel packaging - quantity 1250 per reel.

MJTP1140
4mm x 4mm

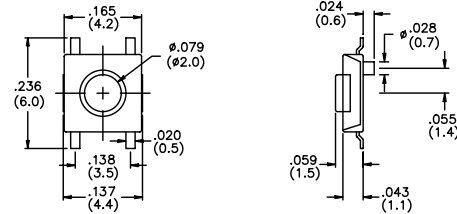

Bulk packaged.

MJTP1140A

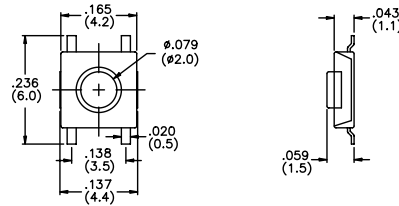

Bulk packaged.

MJTP1140TR & MJTP1140ATR
Same as above, except supplied on tape & reel as shown.

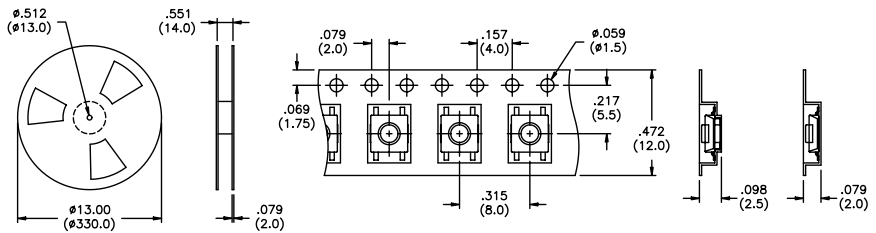

Tape & reel packaging - quantity 3400 per reel.

MJTP1162

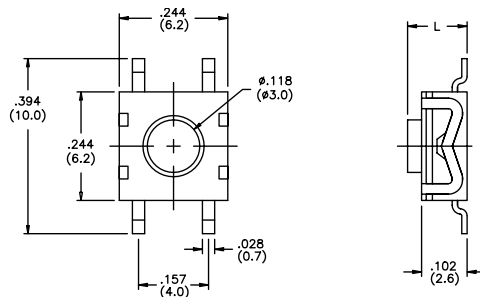

Model No.	Dim. L (in./mm)
MJTP1162	.102 (2,6)
MJTP1162A	.134 (3,4)

Bulk packaged.

MJTP1162TR & MJTP1162ATR

Same as above except supplied on tape & reel as shown.

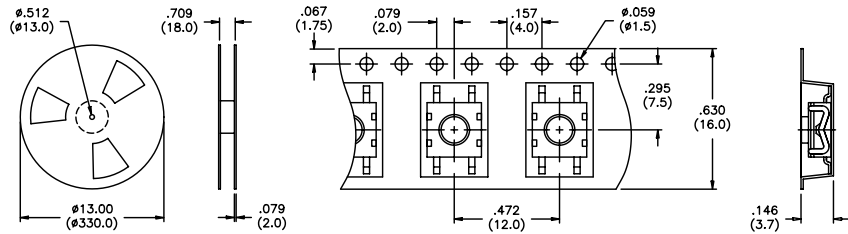

Tape & reel packaging - quantity 1600 per reel.

MJTPSJW66N

Process compatible

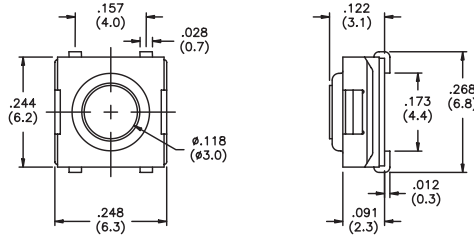

Bulk packaged.

New!

MJTPSJW69N

Process compatible

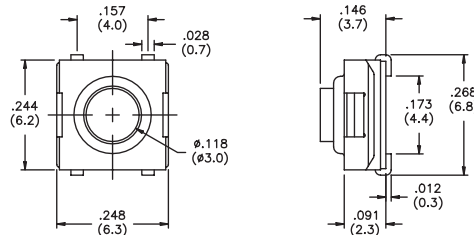

Bulk packaged.

New!

MJTPSJW66NTR & MJTPSJW69NTR

Same as above, except supplied on tape & reel as shown.

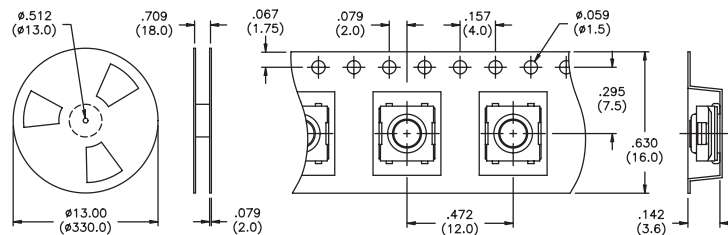

Tape & reel packaging - quantity 1600 per reel.

New!

MJTPSMW

Process compatible

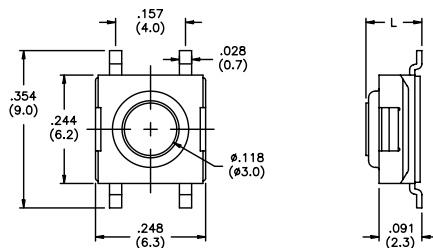

Model No.	Dim. L (in./mm)
MJTPSMW	.122 (3,1)
MJTPSMWA	.091 (2,3)
MJTPSMWB	.146 (3,7)

Bulk packaged.

SPECIFICATIONS SUBJECT TO CHANGE WITHOUT NOTICE.

SPECIFICATIONS SUBJECT TO CHANGE WITHOUT NOTICE.

MJTPSMWTR
MJTPSMWATR
MJTPSMWBTR

Same as above except supplied on tape & reel as shown.

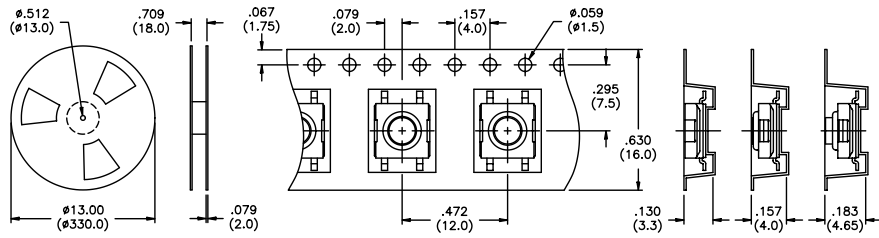

Tape & reel packaging - quantity 'MWTR' & 'MWATR' 2000 per reel, 'MWBTR' 1900 per reel.

SCHEMATICS

MJTP1122
MJTP1125
MJTP1137
MJTP1138
MJTP1140
MJTP1162
MJTPSJW66N
MJTPSJW69N
MJTPSMW

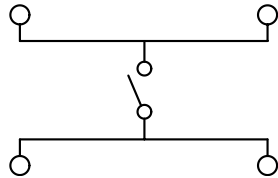

MJTP1106

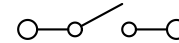

PRINTED CIRCUIT BOARD LAYOUTS

Layout tolerances; Linear: $\pm .004"$ ($\pm 0,1\text{MM}$) Holes: $\pm .002"$ ($\pm 0,05\text{MM}$) Pads: $\pm .008"$ ($\pm 0,2\text{MM}$)

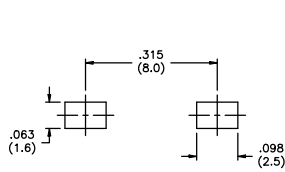

MJTP1106S

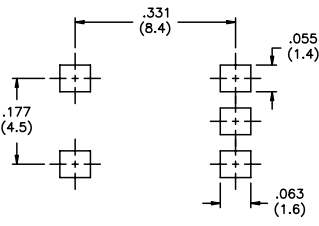

MJTP1122

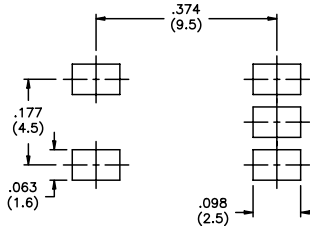

MJTP1122A

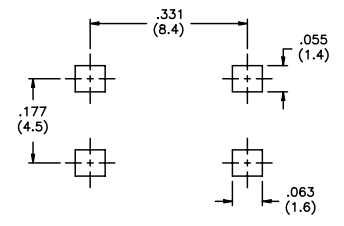

MJTP1122B

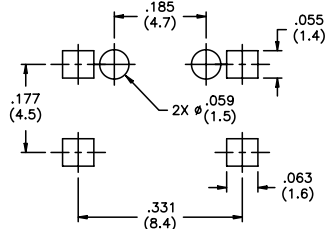

MJTP1137

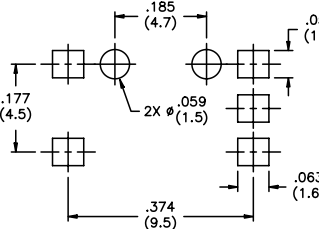

MJTP1137E

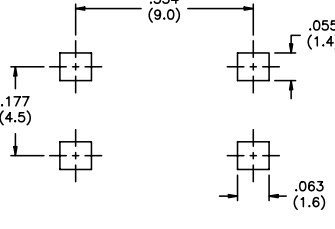

MJTP1138

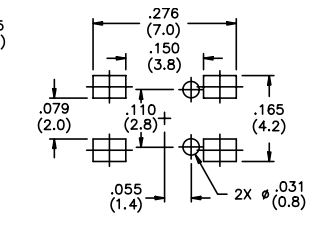

MJTP1140

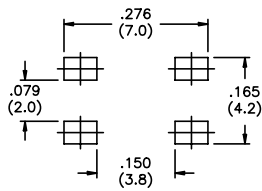

MJTP1140A

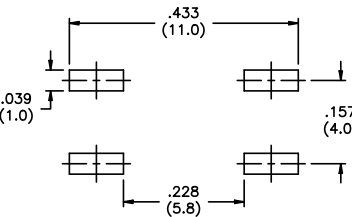

MJTP1162

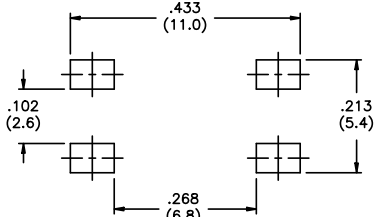

MJTPSMW

F

MHPS SERIES KEY SWITCHES

FEATURES

- Double pole - double throw and 4 pole - double throw configurations.
- Momentary (non-locking) and maintained action (locking) models.
- Shorting and non-shorting contacts.
- Audible ('click') and non-audible action models.

GENERAL SPECIFICATIONS

Contact rating:	100 mA @ 30 VDC
Insulation resistance:	100 megohms minimum at 500 VDC
Dielectric withstanding voltage:	500 VAC for 1 minute
Contact resistance:	100 milliohms maximum
Life:	10,000 cycles minimum
Operating temperature range:	-20°C to +65°C

SOLDERING

Wave soldering:	260°C max. for 5 seconds maximum
Manual soldering:	350°C ± 10°C for 3 seconds maximum
Solvent washing:	Non-washable.

MATERIALS

Case:	PBT (model MHPS2266 only - Type 6/6 nylon)
Cover:	Acetal (model MHPS2266 only - Type 6/6 nylon)
Actuator:	Acetal
Terminals:	Silver plated brass
Shorting Contact:	Silver plated phosphor bronze

SPECIFICATIONS SUBJECT TO CHANGE WITHOUT NOTICE.

F

MHPS2266

Travel: full- .075" (1.9mm)
to lock- .039" (1mm)
Operating force: 140±50g



DOUBLE POLE

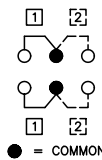
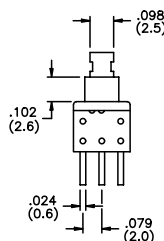
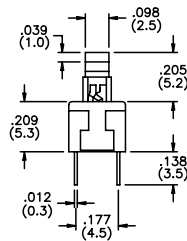
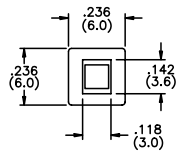

SCHEMATIC

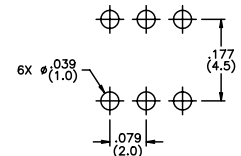

P.C. board layout

Model No.	Action	Contacts	Audible
MHPS2266	maint'd.	non-sh't'g.	no
MHPS2266N	mom.	non-sh't'g.	no

MHPS2273

Travel: full- .071" (1.8mm)
to lock- .039" (1mm)
Operating force: 140±50g



DOUBLE POLE

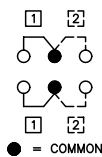
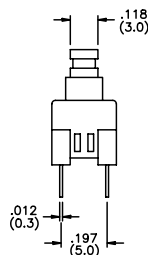
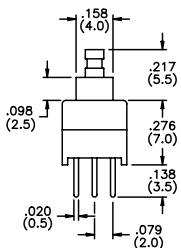
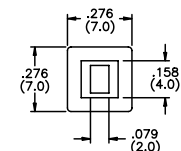

SCHEMATIC

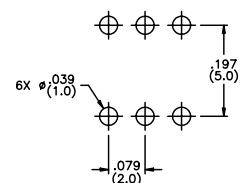

P.C. board layout

Model No.	Action	Contacts	Audible
MHPS2273	maint'd.	non-sh't'g.	no
MHPS2273N	mom.	non-sh't'g.	no

SPECIFICATIONS SUBJECT TO CHANGE WITHOUT NOTICE.

MHPS2283

Travel: full- .098" (2.5mm)
to lock- .059" (1.5mm)
Operating force: 180±50g



DOUBLE POLE

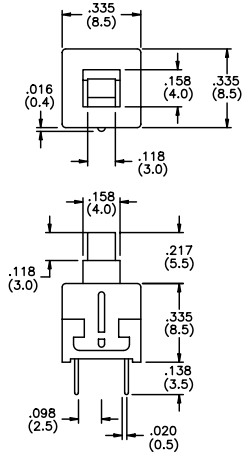

Model No.	Action	Contacts	Audible
MHPS2283	maint'd.	non-shft'g.	yes
MHPS2283N	mom.	non-shft'g.	no
MHPS2283V	mom.	non-shft'g.	yes

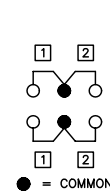

SCHEMATIC

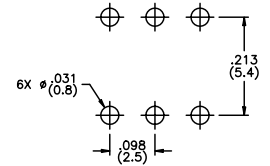

P.C. board layout

MHPS2285

Travel: full- .098" (2.5mm)
to lock- .059" (1.5mm)
Operating force: 180±50g



DOUBLE POLE

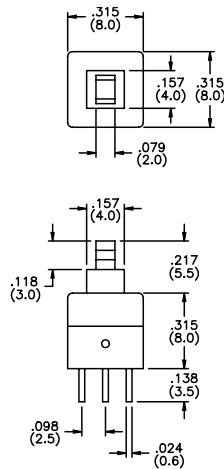

Model No.	Action	Contacts	Audible
MHPS2285	maint'd.	non-shft'g.	yes
MHPS2285N	mom.	non-shft'g.	no
MHPS2285V	mom.	non-shft'g.	yes

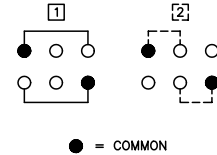

SCHEMATIC

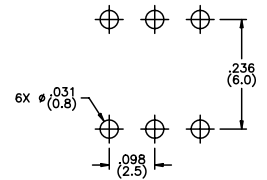

P.C. board layout

MHPS4284

Travel: full- .098" (2.5mm)
to lock- .059" (1.5mm)
Operating force: 180g
+100g, -50g



FOUR POLE

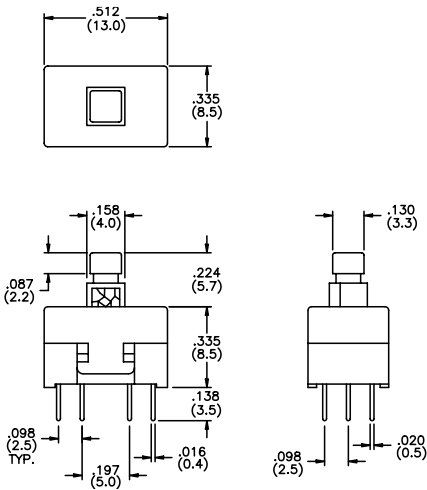

Model No.	Action	Contacts	Audible
MHPS4284	maint'd.	non-shft'g.	no
MHPS4284N	mom.	non-shft'g.	no
MHPS4284V	mom.	non-shft'g.	yes

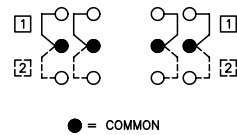

SCHEMATIC

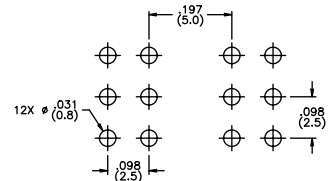

P.C. board layout

CAPS (fit MHPS2273, MHPS2283 and MHPS2285 models only)

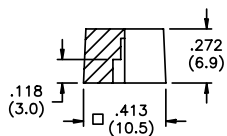

MH1 Square cap

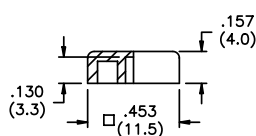

MHU2 Square cap

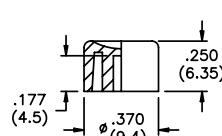

MHU3 Round cap

Note - add digit from table to cap part number for color.
Example - **MH12** indicates black cap.

No.	Color
1	blue
2	black
3	green
5	yellow
6	red
7	ivory

F

MTP SERIES KEY SWITCHES

FEATURES

- Totally sealed - process compatible.
- Excellent tactile feed-back (snap dome).
- Shock & vibration resistance.
- SPST momentary action.

GENERAL SPECIFICATIONS

ELECTRICALS

Contact rating:	50 mA @ 12 VDC
Insulation resistance:	100 megohms minimum at 100 VDC
Dielectric withstanding voltage:	250 VAC for 1 minute
Contact resistance:	100 milliohms maximum
Life:	100,000 cycles minimum

MECHANICALS, THERMALS

Operating force:	160±50 grams
Plunger travel:	.010 +.008 / -.004" (.25 +0.2 / -0.1mm)
Shock:	Withstands 80 g for 3 cycles in each of 6 directions (18 cycles total)
Vibration:	Withstands 10-55 Hz. for 2 hours in each of 3 mutually perpendicular planes, including direction of stem travel.
Operating temperature range:	-20°C to +70°C
Storage temperature range:	-30°C to +80°C

SOLDERING

Wave soldering:	255°C max. for 5 seconds maximum. Preheat - 100°C max. for 45 sec. max.
Manual soldering:	350°C ± 10°C for 3 seconds maximum
Solvent washing:	Washable.

MATERIALS

Case:	Polyetherimide
Cover:	PBT
Actuator:	Acetal
Terminals:	Silver plated brass
Shorting Contact:	Silver plated copper alloy
Internal seal:	Nitrile

SPECIFICATIONS SUBJECT TO CHANGE WITHOUT NOTICE.

F

MTP1149

Process compatible

