

MCV 1,5/12-G-3,81

Order No.: 1803523

The figure shows a 10-position version of the product

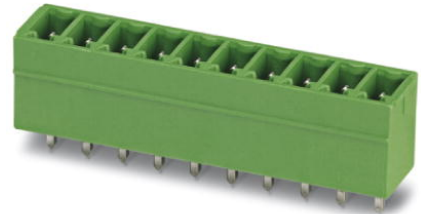

<http://eshop.phoenixcontact.se/phoenix/treeViewClick.do?UID=1803523>

Header, Nominal current: 8 A, Nom. voltage: 160 V, Pitch: 3.81 mm,
Number of positions: 12, Color: green, Assembly: Soldering

Commercial data

EAN	4017918045838
Pack	50
Customs tariff	85366990
Catalog page information	Page 153 (CC-2007)

Product notes

WEEE/RoHS-compliant since:
2003-01-01



Please note that the data given here has been taken from the online catalog. For comprehensive information and data, please refer to the user documentation at <http://www.download.phoenixcontact.com>. The General Terms and Conditions of Use apply to Internet downloads.

Technical data

Dimensions / positions

Pitch	3.81 mm
Dimension a	41.91 mm
Number of positions	12
Pin dimensions	0,8 x 0,8 mm
Hole diameter	1.2 mm

Technical data

Insulating material group	IIIa
Rated surge voltage (III/3)	2.5 kV
Rated surge voltage (III/2)	2.5 kV
Rated surge voltage (II/2)	2.5 kV
Rated voltage (III/2)	160 V
Rated voltage (II/2)	250 V
Connection in acc. with standard	EN-VDE
Nominal current I_N	8 A
Nominal voltage U_N	160 V
Maximum load current	8 A
Insulating material	PBT
Inflammability class acc. to UL 94	V0

Certificates



Certification CB, CSA, CUL, GOST, UL, VDE-PZI

CSA

Nominal voltage U_N	300 V
Nominal current I_N	8 A

CUL

Nominal voltage U_N	300 V
Nominal current I_N	8 A

UL

Nominal voltage U_N	300 V
Nominal current I_N	8 A

Drawings

Drilling diagram

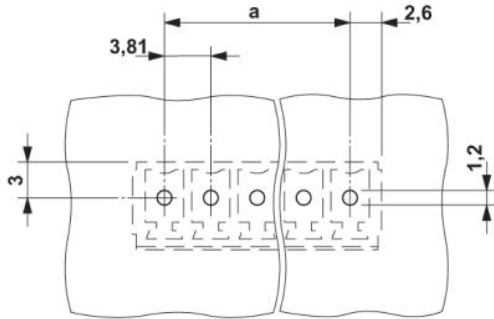

Dimensioned drawing

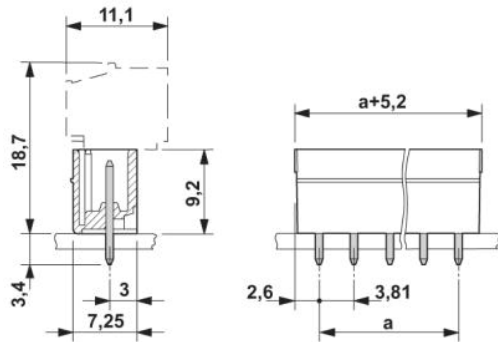

Address

Phoenix Contact AB
Linvägen 2
14144 Huddinge, Sweden
Phone +46 (0)8 - 608 64 00
Fax +46 (0)8 - 608 64 99
<http://www.phoenixcontact.se>

Phoenix Contact Oy
Technical modifications reserved;