

E60105

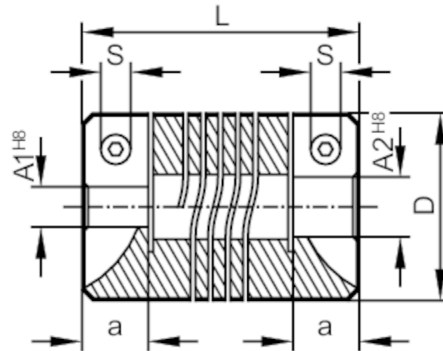

Flexible coupling for encoders

COUPLING 25-8-10-32-KV



Mechanical data

Weight	[g]	33.5
Materials		aluminium
External diameter D	[mm]	25
Inside diameter A1	[mm]	8
Inside diameter A2	[mm]	10
Length L	[mm]	32
Depth of the clamping hub	[mm]	8
Clamp screw	[mm]	M3
Max. revolution, mechanical	[U/min]	6000
Max. axial shaft misalignment	[mm]	± 0,5
Max. radial shaft misalignment	[mm]	± 0,35
Max. angular displacement	[°]	± 4,0

Remarks

Remarks	The data indicated apply to couplings with the above hub borings at an ambient temperature of 23 °C. The values of radial, angular and axial displacement are maximum values which must not reach their maximum simultaneously while in operation.
Pack quantity	1 pcs.