

M12 MALE,90° SHIELDED, D-COD, ETHERNET

PUR 2x2xAWG22 shielded green UL,CSA+dragchain 20m

M12

Male 90°

Ethernet CAT 5e, D-coded

4-pole, shielded

Further cable lengths on request. Plastic housings with good resistance against chemicals and oils. The resistance to aggressive media should be individually tested for your application. Further details on request.

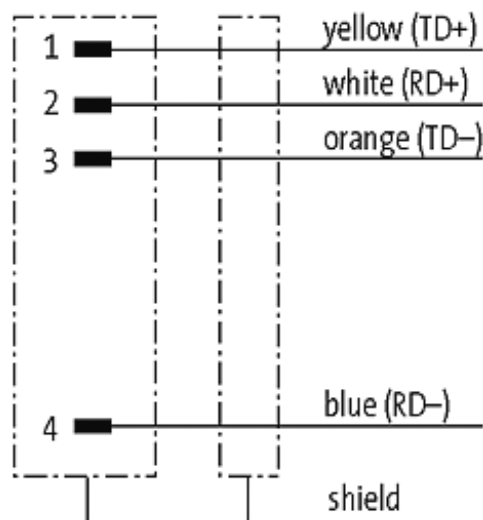
[Link to Product](#)**Illustration**

Male

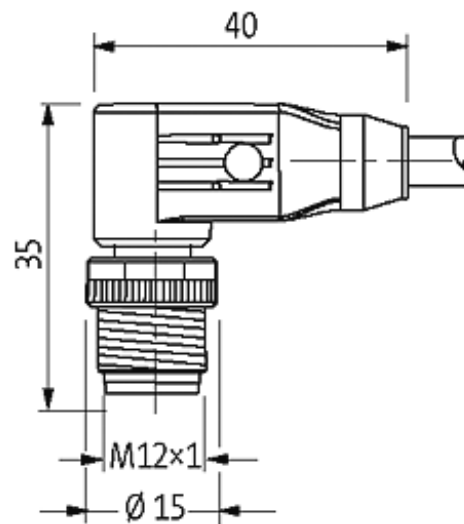
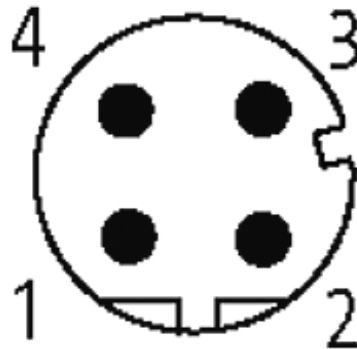

Product may differ from Image

Approvals



More Info





Form

14561

Technical Data

Operating voltage	60 V DC
Operating current per contact	max. 4 A

The information in this brochure has been compiled with the utmost care.

Liability for the correctness completeness and topicality of the information is restricted to gross negligence. Version: 05/15

Murrelektronik GmbH | Falkenstraße 3, 71570 Oppenweiler | Fon +49 (71 91) 47-0, Fax +49 (71 91) 47-491000 | shop@murrelektronik.de | shop.murrelektronik.de

Locking of ports	Screw thread M12 × 1 mm (recommended torque 0.6 Nm) self-securing
Protection	IP67 inserted and tightened (EN 60529)

Cables

Cable number	796
No./diameter of wires	2 × 2 × AWG22
Wire isolation	PE (wh, ye, bl, or)
C-track properties	2 Mio.
Jacket Color	green
Shore hardness outer jacket	90 ± 5A
Material (jacket)	PUR (UL/CSA)
Outer diameter	approx. 6.7 mm
Bend radius (fixed)	5 × outer Ø
Bend radius (moving)	15 × outer Ø
Temperature range (fixed)	-40...+80 °C
Temperature range (mobile)	-20...+60 °C
Shielded	yes

Commercial data

country of origin	DE
customs tariff number	85444290
minimum order quantity	1