

# MOSFET - Power, N-Channel, SUPERFET<sup>®</sup> III, FAST

**650 V, 190 mΩ, 16 A**

## NTPF190N65S3H

### Description

SUPERFET III MOSFET is ON Semiconductor's brand-new high voltage super-junction (SJ) MOSFET family that is utilizing charge balance technology for outstanding low on-resistance and lower gate charge performance. This advanced technology is tailored to minimize conduction loss, provides superior switching performance, and withstand extreme dv/dt rate.

Consequently, SUPERFET III FAST MOSFET series helps minimize various power systems and improve system efficiency.

### Features

- 700 V @  $T_J = 150^\circ\text{C}$
- Typ.  $R_{DS(on)} = 156\text{ m}\Omega$
- Ultra Low Gate Charge (Typ.  $Q_g = 31\text{ nC}$ )
- Low Effective Output Capacitance (Typ.  $C_{oss(eff.)} = 292\text{ pF}$ )
- 100% Avalanche Tested
- These Devices are Pb-Free and are RoHS Compliant

### Applications

- Computing / Display Power Supplies
- Telecom / Server Power Supplies
- Industrial Power Supplies
- Lighting / Charger / Adapter



**ON Semiconductor<sup>®</sup>**

[www.onsemi.com](http://www.onsemi.com)

$V_{DSS}$	$R_{DS(on)}\text{ MAX}$	$I_D\text{ MAX}$
650 V	190 mΩ @ 10 V	16 A

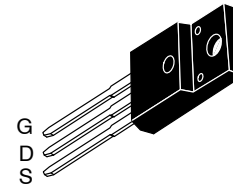
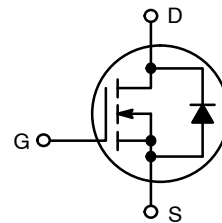

**TO-220 FULLPAK  
CASE 221D**

### MARKING DIAGRAM



T190N65S3H = Specific Device Code  
 A = Assembly Location  
 Y = Year  
 WW = Work Week  
 ZZ = Lot Code

### ORDERING INFORMATION

See detailed ordering and shipping information on page 2 of this data sheet.

# NTPF190N65S3H

## ABSOLUTE MAXIMUM RATINGS (T<sub>C</sub> = 25°C, Unless otherwise specified)

Symbol	Parameter	Value	Unit
V <sub>DSS</sub>	Drain to Source Voltage	650	V
V <sub>GSS</sub>	Gate to Source Voltage	DC	±30
		AC (f > 1 Hz)	±30
I <sub>D</sub>	Drain Current	Continuous (T <sub>C</sub> = 25°C)	16*
		Continuous (T <sub>C</sub> = 100°C)	10*
I <sub>DM</sub>	Drain Current	Pulsed (Note 1)	45*
E <sub>AS</sub>	Single Pulsed Avalanche Energy (Note 2)	142	mJ
I <sub>AS</sub>	Avalanche Current (Note 2)	3.6	A
E <sub>AR</sub>	Repetitive Avalanche Energy (Note 1)	1.29	mJ
dv/dt	MOSFET dv/dt	120	V/ns
	Peak Diode Recovery dv/dt (Note 3)	20	
P <sub>D</sub>	Power Dissipation	(T <sub>C</sub> = 25°C)	32
		Derate Above 25°C	0.25
T <sub>J</sub> , T <sub>STG</sub>	Operating and Storage Temperature Range	-55 to +150	°C
T <sub>L</sub>	Maximum Lead Temperature for Soldering, 1/8" from Case for 5 s	260	°C

Stresses exceeding those listed in the Maximum Ratings table may damage the device. If any of these limits are exceeded, device functionality should not be assumed, damage may occur and reliability may be affected.

\*Drain current limited by maximum junction temperature.

1. Repetitive rating; pulse-width limited by maximum junction temperature.

2. I<sub>AS</sub> = 3.6 A, R<sub>G</sub> = 25 Ω, starting T<sub>J</sub> = 25°C.

3. I<sub>SD</sub> ≤ 8 A, di/dt ≤ 200 A/μs, V<sub>DD</sub> ≤ 400 V, starting T<sub>J</sub> = 25°C.

## THERMAL CHARACTERISTICS

Symbol	Parameter	Value	Unit
R <sub>θJC</sub>	Thermal Resistance, Junction to Case, Max.	3.88	°C/W
R <sub>θJA</sub>	Thermal Resistance, Junction to Ambient, Max.	62.5	

## PACKAGE MARKING AND ORDERING INFORMATION

Part Number	Top Marking	Package	Shipping
NTPF190N65S3H	T190N65S3H	TO-220 FULLPAK	50 Units / Tube

# NTPF190N65S3H

## ELECTRICAL CHARACTERISTICS ( $T_C = 25^\circ\text{C}$ unless otherwise noted)

Symbol	Parameter	Test Conditions	Min	Typ	Max	Unit
--------	-----------	-----------------	-----	-----	-----	------

### OFF CHARACTERISTICS

BV <sub>DSS</sub>	Drain to Source Breakdown Voltage	V <sub>GS</sub> = 0 V, I <sub>D</sub> = 1 mA, T <sub>J</sub> = 25°C	650			V
		V <sub>GS</sub> = 0 V, I <sub>D</sub> = 1 mA, T <sub>J</sub> = 150°C	700			V
ΔBV <sub>DSS</sub> /ΔT <sub>J</sub>	Breakdown Voltage Temperature Coefficient	I <sub>D</sub> = 10 mA, Referenced to 25°C		0.63		V/°C
I <sub>DSS</sub>	Zero Gate Voltage Drain Current	V <sub>DS</sub> = 650 V, V <sub>GS</sub> = 0 V			1	μA
		V <sub>DS</sub> = 520 V, T <sub>C</sub> = 125°C		0.8		
I <sub>GSS</sub>	Gate to Body Leakage Current	V <sub>GS</sub> = ±30 V, V <sub>DS</sub> = 0 V			±100	nA

### ON CHARACTERISTICS

V <sub>GS(th)</sub>	Gate Threshold Voltage	V <sub>GS</sub> = V <sub>DS</sub> , I <sub>D</sub> = 1.4 mA	2.4		4.0	V
R <sub>DS(on)</sub>	Static Drain to Source On Resistance	V <sub>GS</sub> = 10 V, I <sub>D</sub> = 8 A		156	190	mΩ
g <sub>FS</sub>	Forward Transconductance	V <sub>DS</sub> = 20 V, I <sub>D</sub> = 8 A		18		S

### DYNAMIC CHARACTERISTICS

C <sub>iss</sub>	Input Capacitance	V <sub>DS</sub> = 400 V, V <sub>GS</sub> = 0 V, f = 250 kHz		1600		pF
C <sub>oss</sub>	Output Capacitance			23		pF
C <sub>oss(eff.)</sub>	Effective Output Capacitance	V <sub>DS</sub> = 0 V to 400 V, V <sub>GS</sub> = 0 V		292		pF
C <sub>oss(er.)</sub>	Energy Related Output Capacitance	V <sub>DS</sub> = 0 V to 400 V, V <sub>GS</sub> = 0 V		41		pF
Q <sub>g(tot)</sub>	Total Gate Charge at 10 V	V <sub>DS</sub> = 400 V, I <sub>D</sub> = 8 A, V <sub>GS</sub> = 10 V (Note 4)		31		nC
Q <sub>gs</sub>	Gate to Source Gate Charge			7.1		nC
Q <sub>gd</sub>	Gate to Drain "Miller" Charge			7.9		nC
ESR	Equivalent Series Resistance	f = 1 MHz		1.1		Ω

### SWITCHING CHARACTERISTICS

t <sub>d(on)</sub>	Turn-On Delay Time	V <sub>DD</sub> = 400 V, I <sub>D</sub> = 8 A, V <sub>GS</sub> = 10 V, R <sub>g</sub> = 10 Ω (Note 4)		19		ns
t <sub>r</sub>	Turn-On Rise Time			7.8		ns
t <sub>d(off)</sub>	Turn-Off Delay Time			61		ns
t <sub>f</sub>	Turn-Off Fall Time			3.5		ns

### SOURCE-DRAIN DIODE CHARACTERISTICS

I <sub>S</sub>	Maximum Continuous Source to Drain Diode Forward Current			16		A
I <sub>SM</sub>	Maximum Pulsed Source to Drain Diode Forward Current			45		A
V <sub>SD</sub>	Source to Drain Diode Forward Voltage	V <sub>GS</sub> = 0 V, I <sub>SD</sub> = 8 A			1.2	V
t <sub>rr</sub>	Reverse Recovery Time	V <sub>DD</sub> = 400 V, I <sub>SD</sub> = 8 A, dI <sub>F</sub> /dt = 100 A/μs		259		ns
Q <sub>rr</sub>	Reverse Recovery Charge			3.2		μC

Product parametric performance is indicated in the Electrical Characteristics for the listed test conditions, unless otherwise noted. Product performance may not be indicated by the Electrical Characteristics if operated under different conditions.

4. Essentially independent of operating temperature typical characteristics.

# NTPF190N65S3H

## TYPICAL CHARACTERISTICS

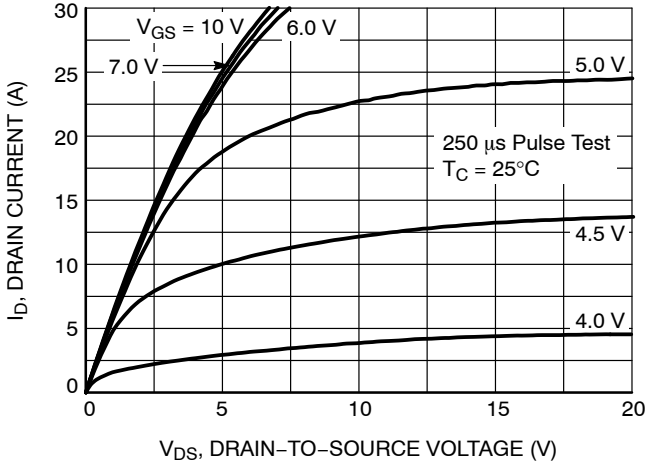

Figure 1. On-Region Characteristics

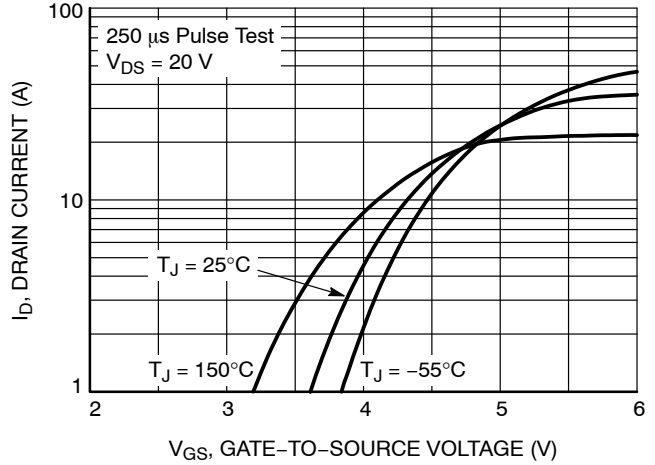

Figure 2. Transfer Characteristics

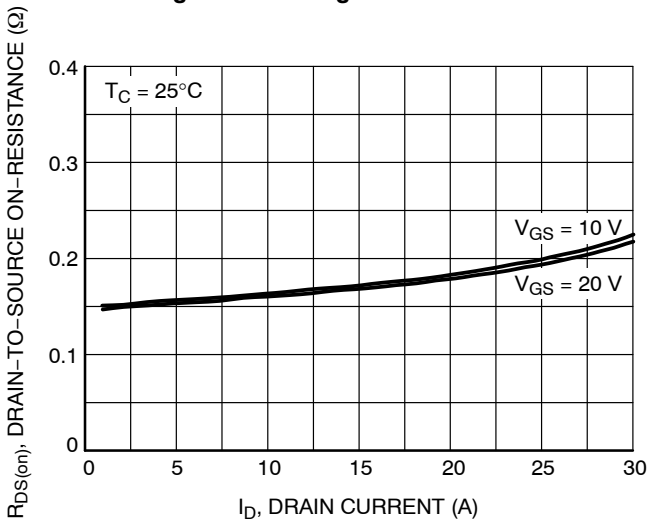

Figure 3. On Resistance Variation vs. Drain Current and Gate Voltage

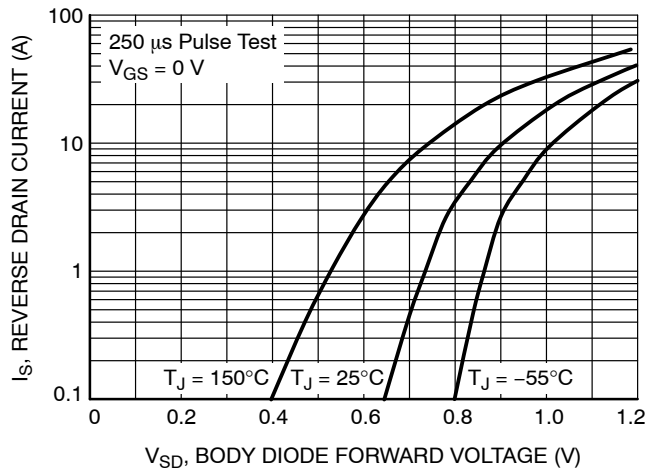

Figure 4. Diode Forward Voltage Variation vs. Source Current and Temperature

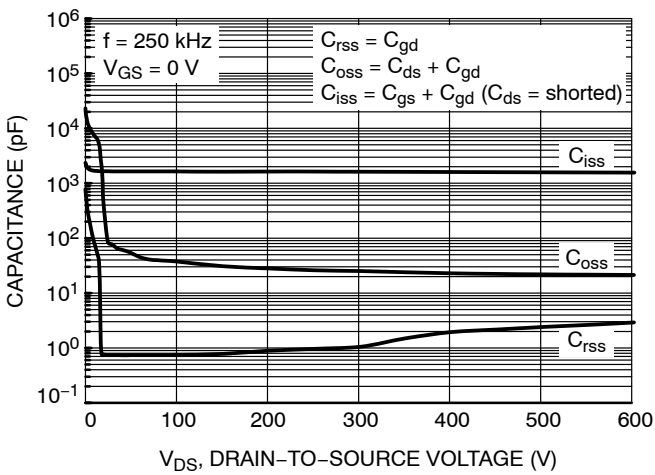

Figure 5. Capacitance Characteristics

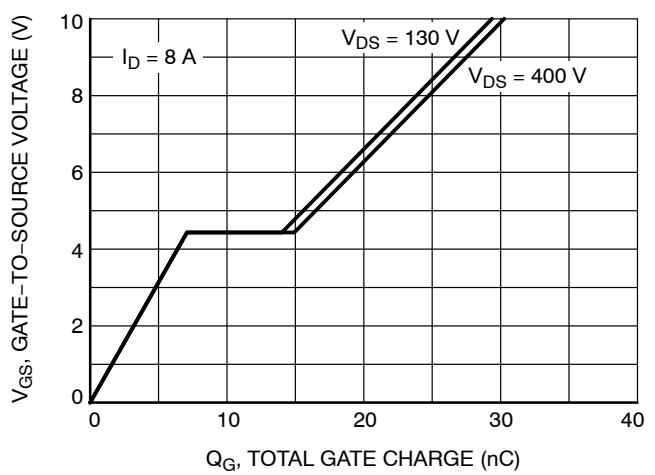
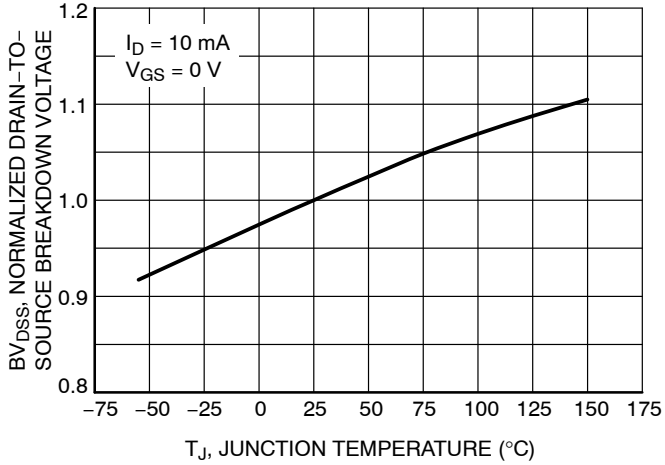

Figure 6. Gate Charge Characteristics

# NTPF190N65S3H

## TYPICAL CHARACTERISTICS



**Figure 7. Breakdown Voltage Variation vs. Temperature**

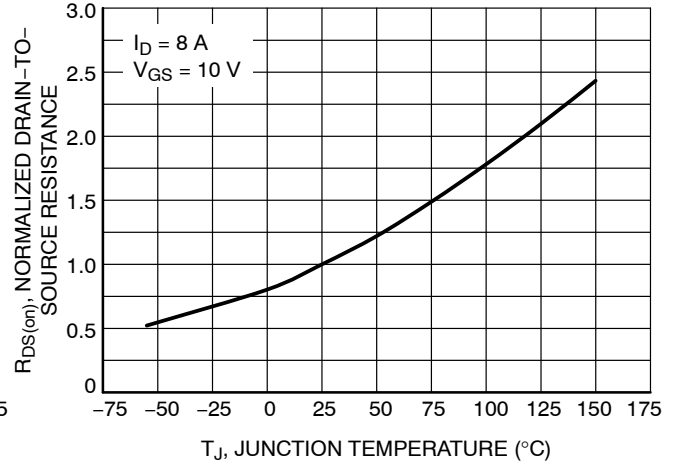

**Figure 8. On-Resistance Variation vs. Temperature**

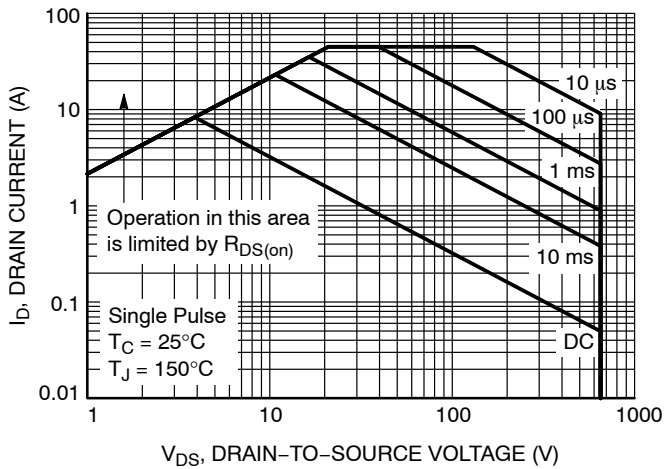

**Figure 9. Maximum Safe Operating Area**

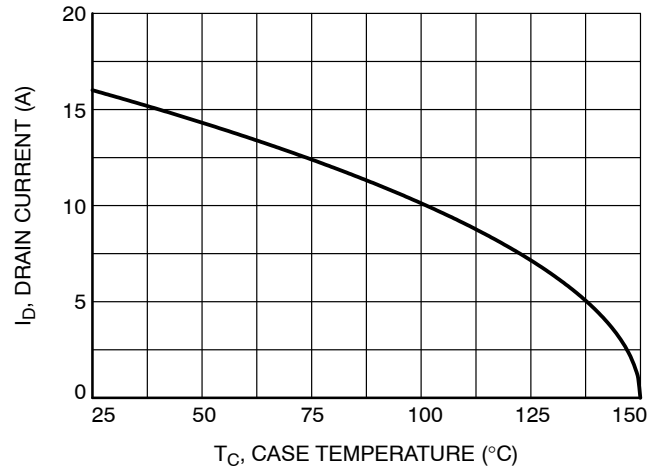

**Figure 10. Maximum Drain Current vs. Case Temperature**

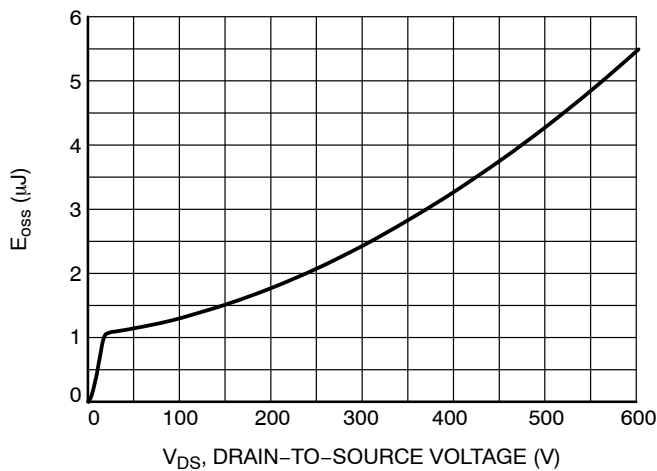

**Figure 11.  $E_{oss}$  vs. Drain-to-Source Voltage**

# NTPF190N65S3H

## TYPICAL CHARACTERISTICS

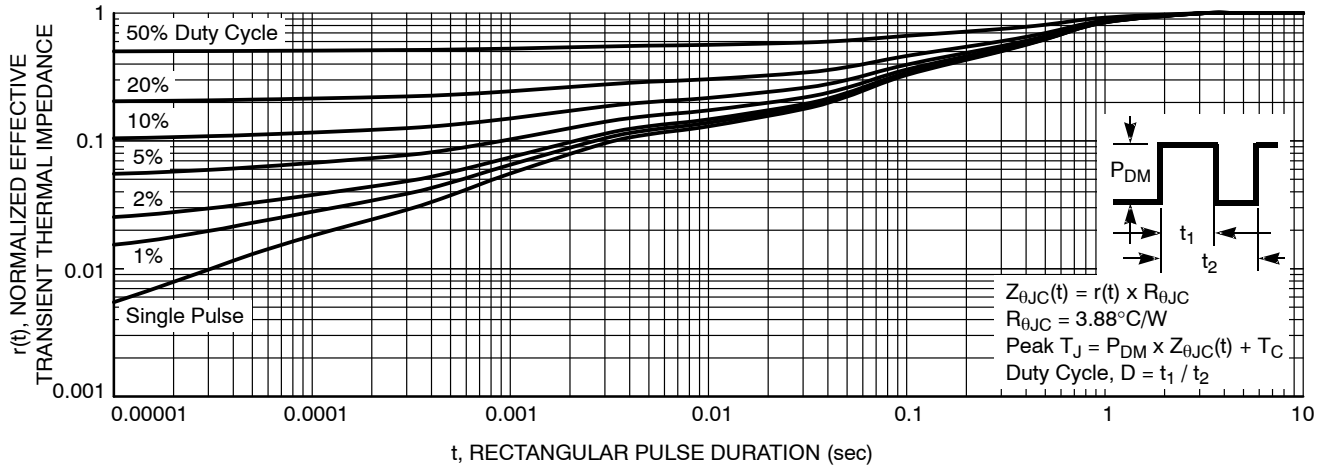

Figure 12. Transient Thermal Response Curve

# NTPF190N65S3H



Figure 13. Gate Charge Test Circuit & Waveform



Figure 14. Resistive Switching Test Circuit & Waveforms

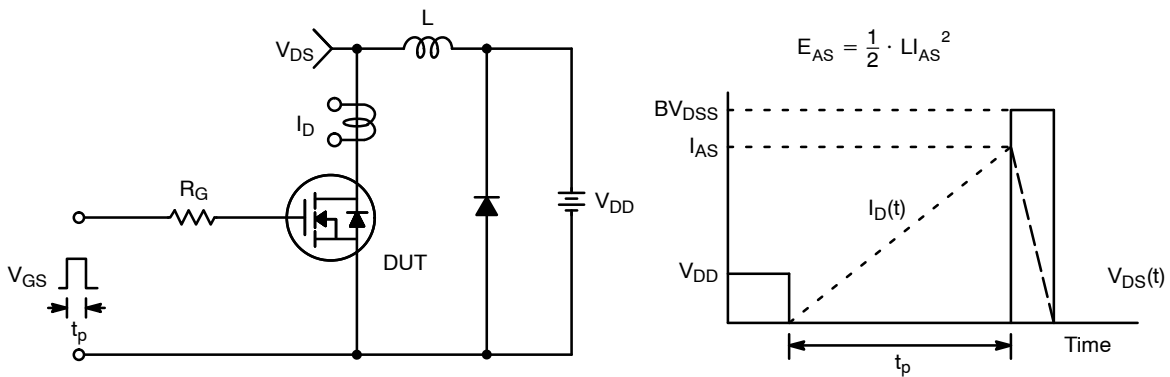
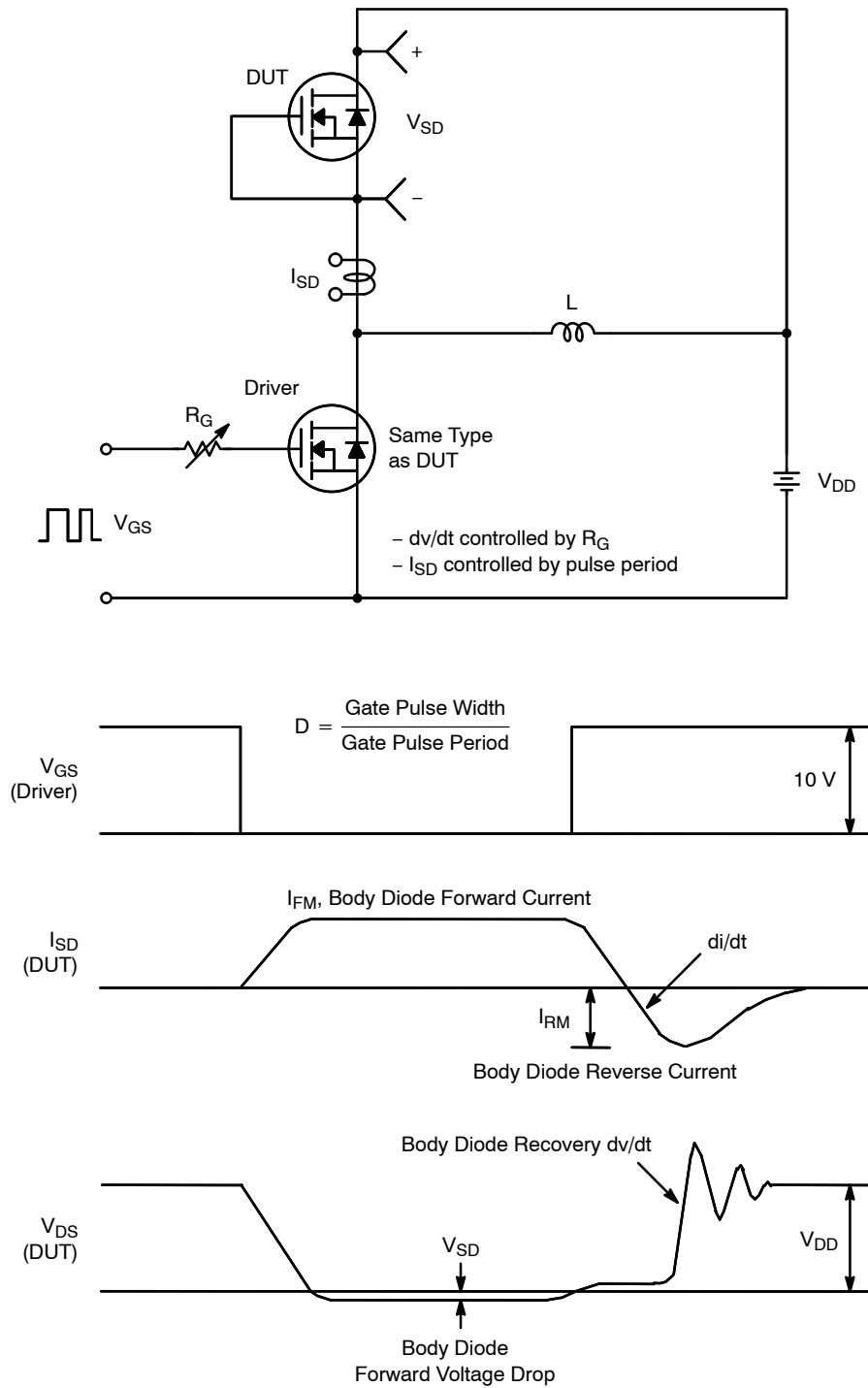

Figure 15. Unclamped Inductive Switching Test Circuit & Waveforms

# NTPF190N65S3H



**Figure 16. Peak Diode Recovery  $dv/dt$  Test Circuit & Waveforms**



# NTPF190N65S3H

## PACKAGE DIMENSIONS

TO-220 FULLPAK  
CASE 221D-03  
ISSUE K

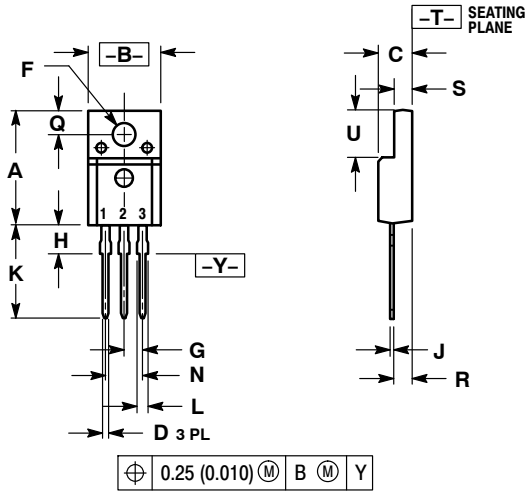

NOTES:

1. DIMENSIONING AND TOLERANCING PER ANSI Y14.5M, 1982.
2. CONTROLLING DIMENSION: INCH
3. 221D-01 THRU 221D-02 OBSOLETE, NEW STANDARD 221D-03.

DIM	INCHES		MILLIMETERS	
	MIN	MAX	MIN	MAX
A	0.617	0.635	15.67	16.12
B	0.392	0.419	9.96	10.63
C	0.177	0.193	4.50	4.90
D	0.024	0.039	0.60	1.00
F	0.116	0.129	2.95	3.28
G	0.100 BSC		2.54 BSC	
H	0.118	0.135	3.00	3.43
J	0.018	0.025	0.45	0.63
K	0.503	0.541	12.78	13.73
L	0.048	0.058	1.23	1.47
N	0.200 BSC		5.08 BSC	
Q	0.122	0.138	3.10	3.50
R	0.099	0.117	2.51	2.96
S	0.092	0.113	2.34	2.87
U	0.239	0.271	6.06	6.88

ON Semiconductor and are trademarks of Semiconductor Components Industries, LLC dba ON Semiconductor or its subsidiaries in the United States and/or other countries. ON Semiconductor owns the rights to a number of patents, trademarks, copyrights, trade secrets, and other intellectual property. A listing of ON Semiconductor's product/patent coverage may be accessed at [www.onsemi.com/site/pdf/Patent-Marking.pdf](http://www.onsemi.com/site/pdf/Patent-Marking.pdf). ON Semiconductor reserves the right to make changes without further notice to any products herein. ON Semiconductor makes no warranty, representation or guarantee regarding the suitability of its products for any particular purpose, nor does ON Semiconductor assume any liability arising out of the application or use of any product or circuit, and specifically disclaims any and all liability, including without limitation special, consequential or incidental damages. Buyer is responsible for its products and applications using ON Semiconductor products, including compliance with all laws, regulations and safety requirements or standards, regardless of any support or applications information provided by ON Semiconductor. "Typical" parameters which may be provided in ON Semiconductor data sheets and/or specifications can and do vary in different applications and actual performance may vary over time. All operating parameters, including "Typicals" must be validated for each customer application by customer's technical experts. ON Semiconductor does not convey any license under its patent rights nor the rights of others. ON Semiconductor products are not designed, intended, or authorized for use as a critical component in life support systems or any FDA Class 3 medical devices or medical devices with a same or similar classification in a foreign jurisdiction or any devices intended for implantation in the human body. Should Buyer purchase or use ON Semiconductor products for any such unintended or unauthorized application, Buyer shall indemnify and hold ON Semiconductor and its officers, employees, subsidiaries, affiliates, and distributors harmless against all claims, costs, damages, and expenses, and reasonable attorney fees arising out of, directly or indirectly, any claim of personal injury or death associated with such unintended or unauthorized use, even if such claim alleges that ON Semiconductor was negligent regarding the design or manufacture of the part. ON Semiconductor is an Equal Opportunity/Affirmative Action Employer. This literature is subject to all applicable copyright laws and is not for resale in any manner.

### PUBLICATION ORDERING INFORMATION

LITERATURE FULFILLMENT:  
Email Requests to: [orderlit@onsemi.com](mailto:orderlit@onsemi.com)

TECHNICAL SUPPORT  
North American Technical Support:  
Voice Mail: 1 800-282-9855 Toll Free USA/Canada  
Phone: 011 421 33 790 2910

Europe, Middle East and Africa Technical Support:  
Phone: 00421 33 790 2910  
For additional information, please contact your local Sales Representative