



Is Now Part of



**ON Semiconductor®**

To learn more about ON Semiconductor, please visit our website at  
[www.onsemi.com](http://www.onsemi.com)

ON Semiconductor and the ON Semiconductor logo are trademarks of Semiconductor Components Industries, LLC dba ON Semiconductor or its subsidiaries in the United States and/or other countries. ON Semiconductor owns the rights to a number of patents, trademarks, copyrights, trade secrets, and other intellectual property. A listing of ON Semiconductor's product/patent coverage may be accessed at [www.onsemi.com/site/pdf/Patent-Marking.pdf](http://www.onsemi.com/site/pdf/Patent-Marking.pdf). ON Semiconductor reserves the right to make changes without further notice to any products herein. ON Semiconductor makes no warranty, representation or guarantee regarding the suitability of its products for any particular purpose, nor does ON Semiconductor assume any liability arising out of the application or use of any product or circuit, and specifically disclaims any and all liability, including without limitation special, consequential or incidental damages. Buyer is responsible for its products and applications using ON Semiconductor products, including compliance with all laws, regulations and safety requirements or standards, regardless of any support or applications information provided by ON Semiconductor. "Typical" parameters which may be provided in ON Semiconductor data sheets and/or specifications can and do vary in different applications and actual performance may vary over time. All operating parameters, including "Typicals" must be validated for each customer application by customer's technical experts. ON Semiconductor does not convey any license under its patent rights nor the rights of others. ON Semiconductor products are not designed, intended, or authorized for use as a critical component in life support systems or any FDA Class 3 medical devices or medical devices with a same or similar classification in a foreign jurisdiction or any devices intended for implantation in the human body. Should Buyer purchase or use ON Semiconductor products for any such unintended or unauthorized application, Buyer shall indemnify and hold ON Semiconductor and its officers, employees, subsidiaries, affiliates, and distributors harmless against all claims, costs, damages, and expenses, and reasonable attorney fees arising out of, directly or indirectly, any claim of personal injury or death associated with such unintended or unauthorized use, even if such claim alleges that ON Semiconductor was negligent regarding the design or manufacture of the part. ON Semiconductor is an Equal Opportunity/Affirmative Action Employer. This literature is subject to all applicable copyright laws and is not for resale in any manner.



October 2015

FDN5630

# FDN5630

## 60V N-Channel PowerTrench® MOSFET

### General Description

This N-Channel MOSFET has been designed specifically to improve the overall efficiency of DC/DC converters using either synchronous or conventional switching PWM controllers.

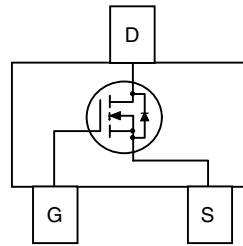
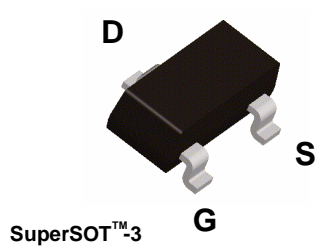
This MOSFET features very low  $R_{DS(ON)}$  in a small SOT23 footprint. Fairchild's PowerTrench technology provides faster switching than other MOSFETs with comparable  $R_{DS(ON)}$  specifications. The result is higher overall efficiency with less board space.

### Features

- 1.7 A, 60 V.  $R_{DS(ON)} = 0.100 \Omega @ V_{GS} = 10 \text{ V}$   
 $R_{DS(ON)} = 0.120 \Omega @ V_{GS} = 6 \text{ V}$ .
- Optimized for use in high frequency DC/DC converters.
- Low gate charge.
- Very fast switching.
- SuperSOT™ - 3 provides low  $R_{DS(ON)}$  in SOT23 footprint.

### Applications

- DC/DC converter
- Motor drives



### Absolute Maximum Ratings $T_A = 25 \text{ C}$ unless otherwise noted

Symbol	Parameter	Rated	Units
$V_{DSS}$	Drain-Source Voltage	60	V
$V_{GSS}$	Gate-Source Voltage	$\pm 20$	V
$I_D$	Drain Current - Continuous (Note 1a) - Pulsed	1.7	A
		10	
$P_D$	Power Dissipation for Single Operation (Note 1a) (Note 1b)	0.5	W
		0.46	
$T_J, T_{stg}$	Operating and Storage Junction Temperature Range	-55 to +150	$^{\circ}\text{C}$

### Thermal Characteristics

$R_{\theta JA}$	Thermal Resistance, Junction-to-Ambient (Note 1a)	250	$^{\circ}\text{C/W}$
$R_{\theta JC}$	Thermal Resistance, Junction-to-Case (Note 1)	75	$^{\circ}\text{C/W}$

### Package Marking and Ordering Information

Device Marking	Device	Reel Size	Tape Width	Quantity
5630	FDN5630	7	8mm	3000 units

**Electrical Characteristics** $T_A = 25\text{ C}$  unless otherwise noted

Symbol	Parameter	Test Conditions	Min	Typ	Max	Units
--------	-----------	-----------------	-----	-----	-----	-------

**Off Characteristics**

$BV_{DSS}$	Drain-Source Breakdown Voltage	$V_{GS} = 0\text{ V}, I_D = 250\text{ }\mu\text{A}$	60			V
$\frac{\Delta BV_{DSS}}{\Delta T_J}$	Breakdown Voltage Temperature Coefficient	$I_D = 250\text{ }\mu\text{A}$ , Referenced to $25^\circ\text{C}$		63		mV/ $^\circ\text{C}$
$I_{DSS}$	Zero Gate Voltage Drain Current	$V_{DS} = 48\text{ V}, V_{GS} = 0\text{ V}$			1	$\mu\text{A}$
$I_{GSSF}$	Gate-Body Leakage Current, Forward	$V_{GS} = 20\text{ V}, V_{DS} = 0\text{ V}$			100	nA
$I_{GSSR}$	Gate-Body Leakage Current, Reverse	$V_{GS} = -20\text{ V}, V_{DS} = 0\text{ V}$			-100	nA

**On Characteristics** (Note 2)

$V_{GS(th)}$	Gate Threshold Voltage	$V_{DS} = V_{GS}, I_D = 250\text{ }\mu\text{A}$	1	2.4	3	V
$\frac{\Delta V_{GS(th)}}{\Delta T_J}$	Gate Threshold Voltage Temperature Coefficient	$I_D = 250\text{ }\mu\text{A}$ , Referenced to $25^\circ\text{C}$		-6.9		mV/ $^\circ\text{C}$
$R_{DS(on)}$	Static Drain-Source On-Resistance	$V_{GS} = 10\text{ V}, I_D = 1.7\text{ A}$ $V_{GS} = 10\text{ V}, I_D = 1.7\text{ A}, T_J = 125^\circ\text{C}$ $V_{GS} = 6\text{ V}, I_D = 1.6\text{ A}$		0.073 0.127 0.083	0.100 0.180 0.120	$\Omega$
$I_{D(on)}$	On-State Drain Current	$V_{GS} = 10\text{ V}, V_{DS} = 1.7\text{ V}$	5			A
$g_{FS}$	Forward Transconductance	$V_{DS} = 10\text{ V}, I_D = 1.7\text{ A}$		6		S

**Dynamic Characteristics**

$C_{iss}$	Input Capacitance	$V_{DS} = 15\text{ V}, V_{GS} = 0\text{ V},$ $f = 1.0\text{ MHz}$		400	560	pF
$C_{oss}$	Output Capacitance			65	95	pF
$C_{riss}$	Reverse Transfer Capacitance			27	40	pF

**Switching Characteristics** (Note 2)

$t_{d(on)}$	Turn-On Delay Time	$V_{DD} = 30\text{ V}, I_D = 1\text{ A},$ $V_{GS} = 10\text{ V}, R_{GEN} = 6\text{ }\Omega$		10	20	ns
$t_r$	Turn-On Rise Time			6	15	ns
$t_{d(off)}$	Turn-Off Delay Time			15	28	ns
$t_f$	Turn-Off Fall Time			5	15	ns
$Q_g$	Total Gate Charge	$V_{DS} = 20\text{ V}, I_D = 1.7\text{ A},$ $V_{GS} = 10\text{ V},$		7	10	nC
$Q_{gs}$	Gate-Source Charge			1.6		nC
$Q_{gd}$	Gate-Drain Charge			1.2		nC

**Drain-Source Diode Characteristics and Maximum Ratings**

$I_S$	Maximum Continuous Drain-Source Diode Forward Current			0.42		A
$V_{SD}$	Drain-Source Diode Forward Voltage	$V_{GS} = 0\text{ V}, I_S = 0.42\text{ A}$ (Note 2)		0.72	1.2	V

**Notes:**

1:  $R_{\theta JA}$  is the sum of the junction-to-case and case-to-ambient thermal resistance where the case thermal reference is defined as the solder mounting surface of the drain pins.  $R_{\theta JC}$  is guaranteed by design while  $R_{\theta JA}$  is determined by the user's board design.



a)  $250^\circ\text{C/W}$  when mounted on a  $0.02\text{ in}^2$  Pad of 2 oz. Cu.



b)  $270^\circ\text{C/W}$  when mounted on a minimum pad.

Scale 1 : 1 on letter size paper

2: Pulse Test: Pulse Width  $\leq 300\text{ }\mu\text{s}$ , Duty Cycle  $\leq 2.0\%$

## Typical Characteristics

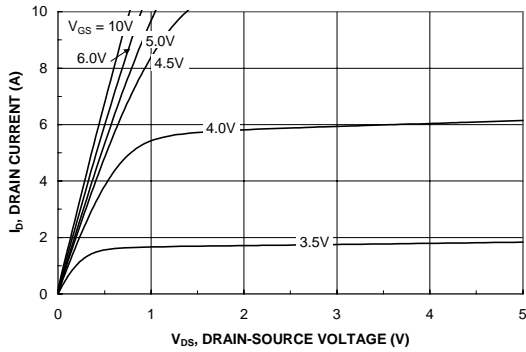


Figure 1. On-Region Characteristics.

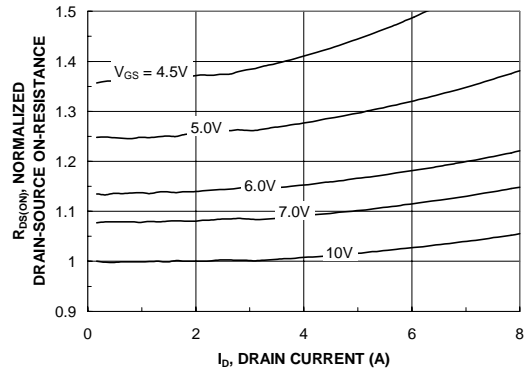


Figure 2. On-Resistance Variation with Drain Current and Gate Voltage.

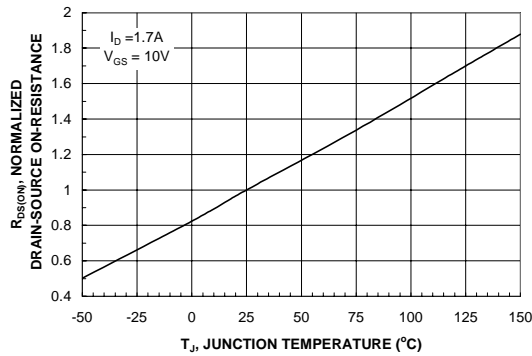


Figure 3. On-Resistance Variation with Temperature.

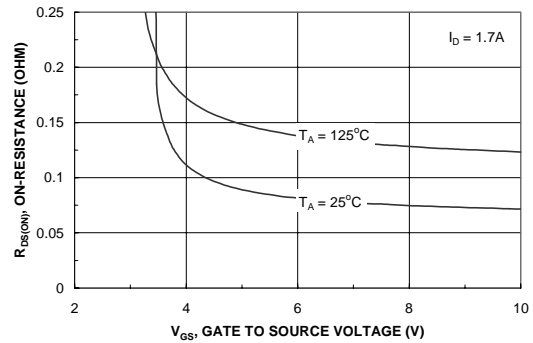


Figure 4. On-Resistance Variation with Gate-to-Source Voltage.

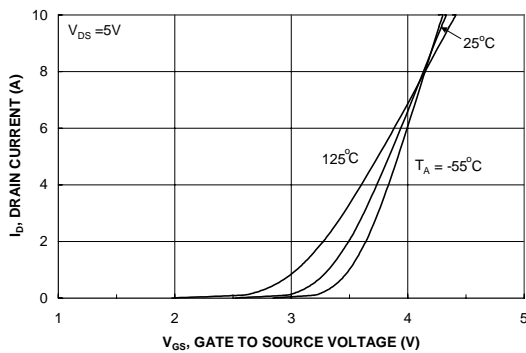


Figure 5. Transfer Characteristics.

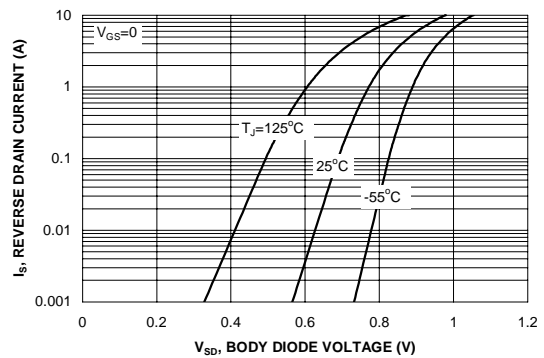
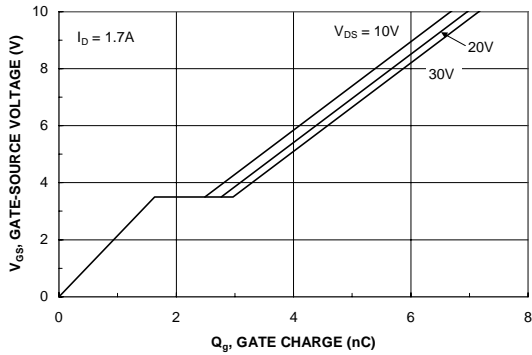
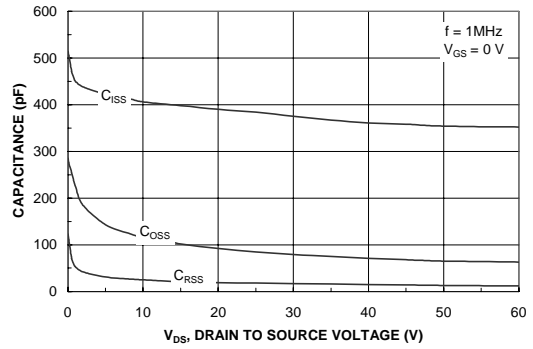


Figure 6. Body Diode Forward Voltage Variation with Source Current and Temperature.

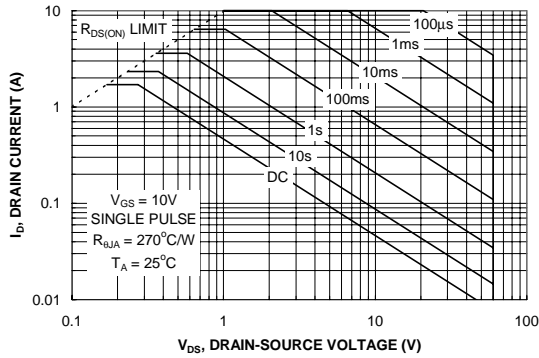
**Typical Characteristics** (continued)



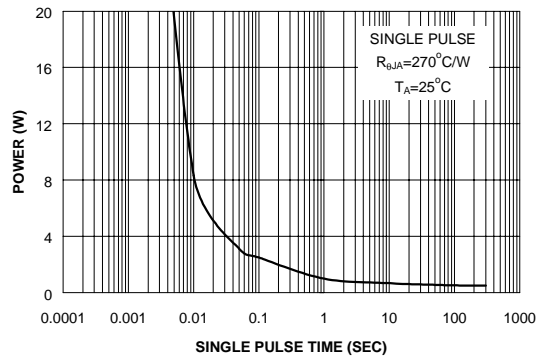
**Figure 7. Gate Charge Characteristics.**



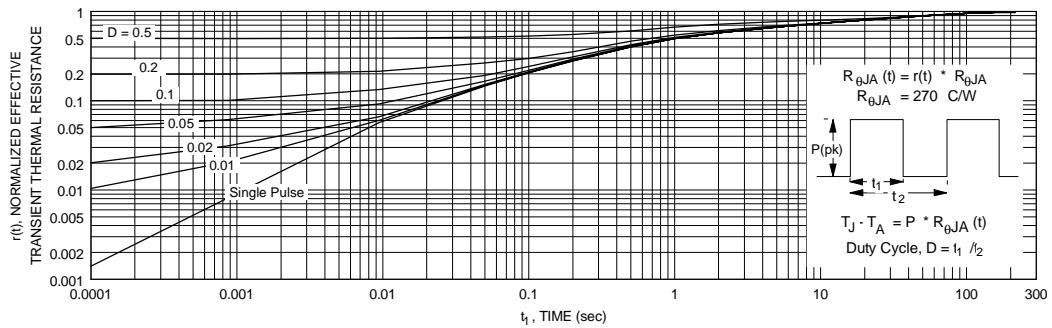
**Figure 8. Capacitance Characteristics.**



**Figure 9. Maximum Safe Operating Area.**

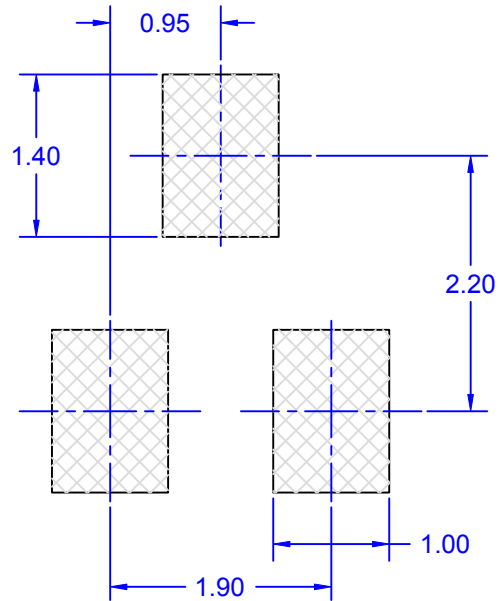
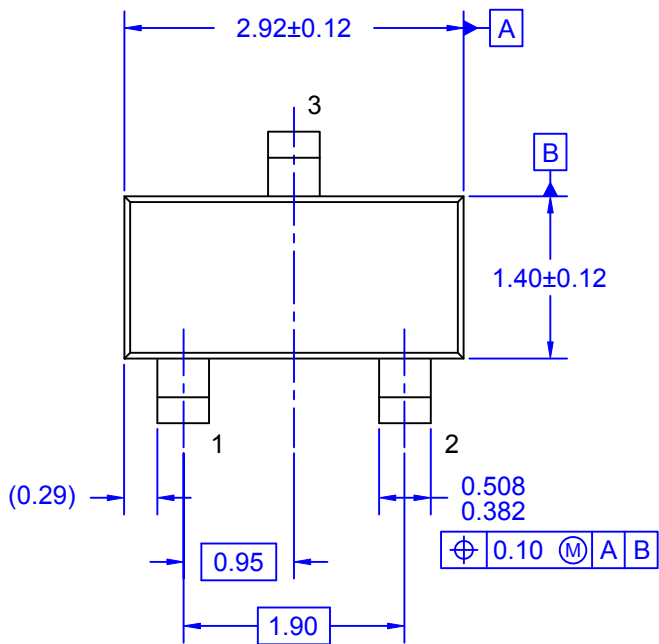


**Figure 10. Single Pulse Maximum Power Dissipation.**

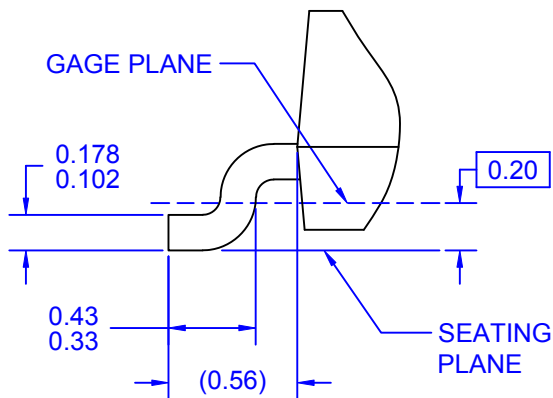
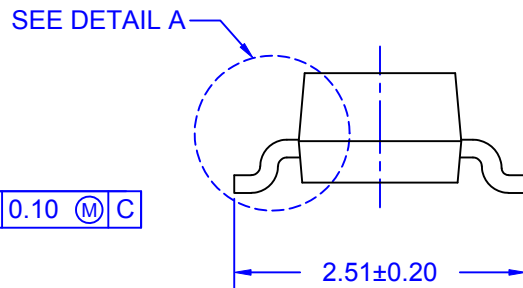
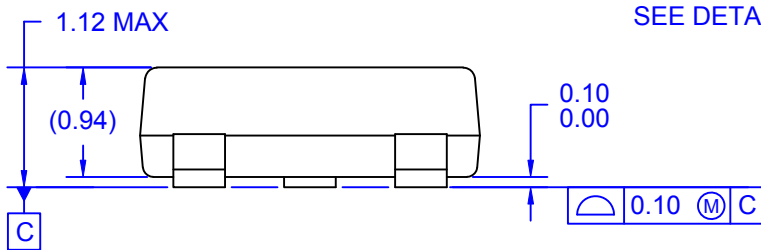


**Figure 11. Transient Thermal Response Curve.**

Thermal characterization performed using the conditions described in Note 1b. Transient thermal response will change depending on the circuit board design.



LAND PATTERN RECOMMENDATION



**DETAIL A**

SCALE: 50:1

NOTES: UNLESS OTHERWISE SPECIFIED

- A) NO JEDEC REFERENCE AS OF AUGUST 2003
- B) ALL DIMENSIONS ARE IN MILLIMETERS.
- C) DIMENSIONS ARE EXCLUSIVE OF BURRS, MOLD FLASH AND TIE BAR EXTRUSIONS.
- D) DIMENSIONING AND TOLERANCING PER ASME Y14.5M - 2009.
- E) DRAWING FILE NAME: MKT-MA03BREV3



ON Semiconductor and  are trademarks of Semiconductor Components Industries, LLC dba ON Semiconductor or its subsidiaries in the United States and/or other countries. ON Semiconductor owns the rights to a number of patents, trademarks, copyrights, trade secrets, and other intellectual property. A listing of ON Semiconductor's product/patent coverage may be accessed at [www.onsemi.com/site/pdf/Patent-Marking.pdf](http://www.onsemi.com/site/pdf/Patent-Marking.pdf). ON Semiconductor reserves the right to make changes without further notice to any products herein. ON Semiconductor makes no warranty, representation or guarantee regarding the suitability of its products for any particular purpose, nor does ON Semiconductor assume any liability arising out of the application or use of any product or circuit, and specifically disclaims any and all liability, including without limitation special, consequential or incidental damages. Buyer is responsible for its products and applications using ON Semiconductor products, including compliance with all laws, regulations and safety requirements or standards, regardless of any support or applications information provided by ON Semiconductor. "Typical" parameters which may be provided in ON Semiconductor data sheets and/or specifications can and do vary in different applications and actual performance may vary over time. All operating parameters, including "Typicals" must be validated for each customer application by customer's technical experts. ON Semiconductor does not convey any license under its patent rights nor the rights of others. ON Semiconductor products are not designed, intended, or authorized for use as a critical component in life support systems or any FDA Class 3 medical devices or medical devices with a same or similar classification in a foreign jurisdiction or any devices intended for implantation in the human body. Should Buyer purchase or use ON Semiconductor products for any such unintended or unauthorized application, Buyer shall indemnify and hold ON Semiconductor and its officers, employees, subsidiaries, affiliates, and distributors harmless against all claims, costs, damages, and expenses, and reasonable attorney fees arising out of, directly or indirectly, any claim of personal injury or death associated with such unintended or unauthorized use, even if such claim alleges that ON Semiconductor was negligent regarding the design or manufacture of the part. ON Semiconductor is an Equal Opportunity/Affirmative Action Employer. This literature is subject to all applicable copyright laws and is not for resale in any manner.

## PUBLICATION ORDERING INFORMATION

### LITERATURE FULFILLMENT:

Literature Distribution Center for ON Semiconductor  
19521 E. 32nd Pkwy, Aurora, Colorado 80011 USA  
**Phone:** 303-675-2175 or 800-344-3860 Toll Free USA/Canada  
**Fax:** 303-675-2176 or 800-344-3867 Toll Free USA/Canada  
**Email:** [orderlit@onsemi.com](mailto:orderlit@onsemi.com)

**N. American Technical Support:** 800-282-9855 Toll Free  
USA/Canada  
**Europe, Middle East and Africa Technical Support:**  
Phone: 421 33 790 2910  
**Japan Customer Focus Center**  
Phone: 81-3-5817-1050

**ON Semiconductor Website:** [www.onsemi.com](http://www.onsemi.com)  
**Order Literature:** <http://www.onsemi.com/orderlit>  
For additional information, please contact your local  
Sales Representative