

CLIFF

METAL FEEDTHROUGH CONNECTORS FT Series

The Metal FT Series of true feed through connectors are perfect for developing custom I/O configurations for wall-plates, rack panels, etc. ALL fit within a standard XLR panel cutout, and use common cabling for front and back connections. No soldering, no punch terminations, just use the standard cable for that particular connector style. Mount from the front or back, low rear profile accommodates the tightest “behind the panel” spaces. Available in a wide variety of styles.

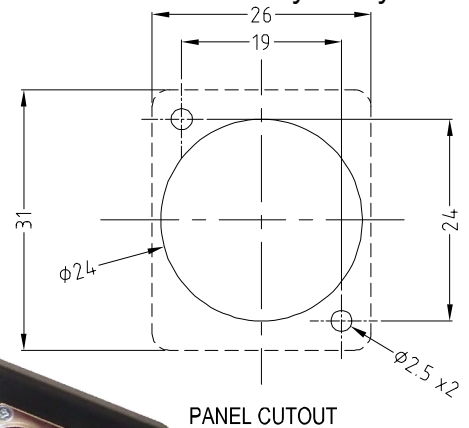

Part No. **Description**
CP30200GM HDMI A Female to HDMI A, Gold Plated, CSK hole.

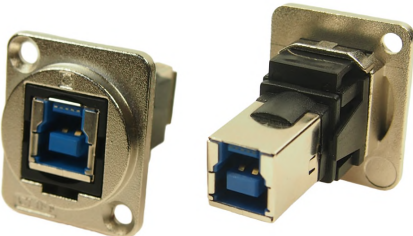

Part No. **Description**
CP30203NM USB 2.0 B to USB 2.0 B, Nickel Plated, CSK hole.

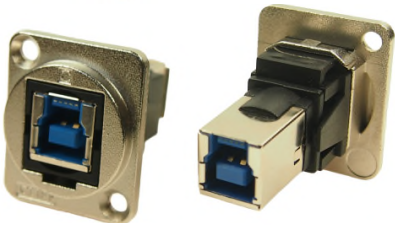

Part No. **Description**
CP30204NM USB 3.0 B to USB 3.0 B, Nickel Plated, CSK hole.

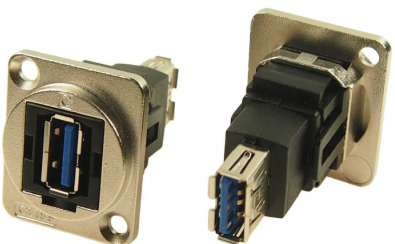

Part No. **Description**
CP30205NM USB 3.0 A to USB 3.0 A, Nickel Plated, CSK hole.



Part No. **Description**
CP30206NM USB 3.0 B to USB 3.0 A, Nickel Plated, CSK hole.

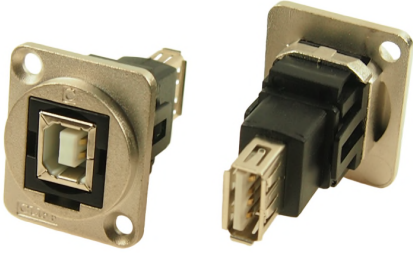

Part No. **Description**
CP30207NM USB 2.0 B to USB 2.0 A, Nickel Plated, CSK hole.

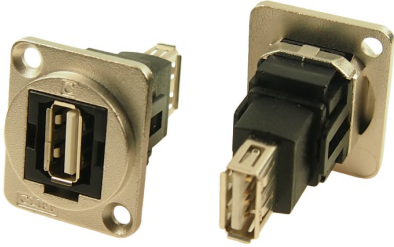

Part No. **Description**
CP30208NM USB 2.0 A to USB 2.0 A, Nickel Plated, CSK hole.



Part No. **Description**
CP30209NM USB 2.0 A to USB 2.0 B, Nickel Plated, CSK hole.

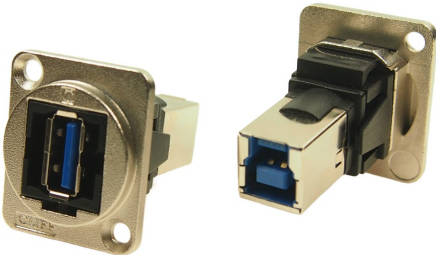

Part No. **Description**
CP30210NM USB 3.0 A to USB 3.0 B, Nickel Plated, CSK hole.

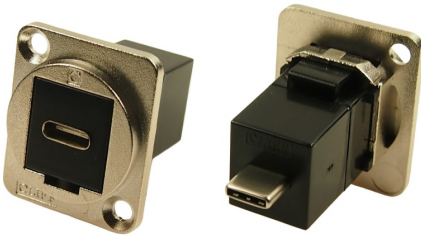

Part No. **Description**
CP30211M USB C Female to Male, Nickel Plated, CSK hole.

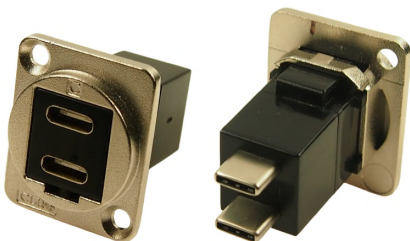

Part No. **Description**
CP30212M Dual USB C Female to Male, Nickel Plated, CSK hole.

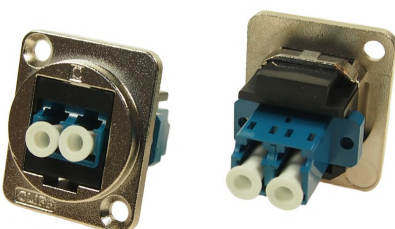

Part No. **Description**
CP30213M LC Duplex SM adaptor, Nickel Plated, CSK Hole



Part No. **Description**
CP30214M LC Duplex MM, Nickel Plated, CSK Hole



Part No. **Description**
CP30215M SC Simplex SM, Nickel Plated, CSK Hole



Part No. **Description**
CP30216M SC Simplex MM, Nickel Plated, CSK Hole



Part No. **Description**
CP30217M Toslink, CSK Hole



Part No. **Description**
CP30220M UTP Cat5e RJ45-RJ45, CSK Hole



Part No. **Description**
CP30220SM FTP Cat5e RJ45-RJ45, Shielded, CSK Hole



Part No. **Description**
CP30222M UTP Cat6 RJ45-RJ45, CSK Hole



Part No. **Description**
CP30222SM FTP Cat6 RJ45-RJ45, Shielded, CSK Hole

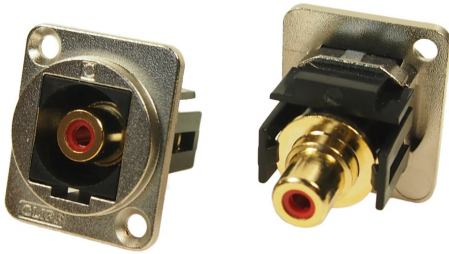

Part No.
CP30230M **Description**
RCA Phono RED, CSK Hole



Part No.
CP30231M **Description**
RCA Phono WHITE, CSK Hole

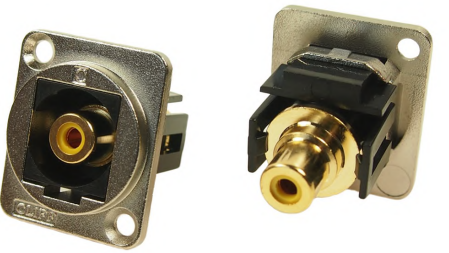

Part No.
CP30232M **Description**
RCA Phono YELLOW, CSK Hole

Other colours available on request.

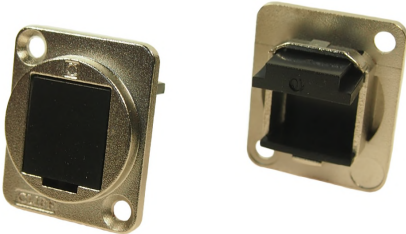

Part No.
CP30241M **Description**
Blanking Plate, CSK Hole



Part No.
CP30110 **Description**
XLR USB A Female to USB B Female, CSK Hole



Part No.
CP30111 **Description**
XLR USB B Female to USB A Female, CSK Hole



Part No.
CP30116 **Description**
XLR HDMI A-A, CSK Hole



Part No.
CP30117 **Description**
XLR Firewire, CSK Hole



Part No.
CP30118

Description
XLR 50 OHM BNC, CSK Hole



Part No.
CP30119

Description
XLR 75 OHM BNC, CSK Hole



Part No.
CP30123

Description
XLR 50 OHM INSULATED BNC, CSK Hole

NEW



Part No.
CP30124

Description
XLR 75 OHM INSULATED BNC, CSK Hole

NEW



Part No.
CP30112

Description
Cover for models CP30110, CP30111, CP30116,
CP30117 only.

For further information, contact sales@cliffuk.co.uk

Cliff Electronic Components Limited

76 Holmethorpe Avenue, Holmethorpe Ind. Estate,
Redhill, Surrey RH1 2PF U.K.

Tel: +44 (0)1737 771375 Fax: +44 (0)1737 766012



Visit us online at:



www.cliffuk.co.uk