

1:5

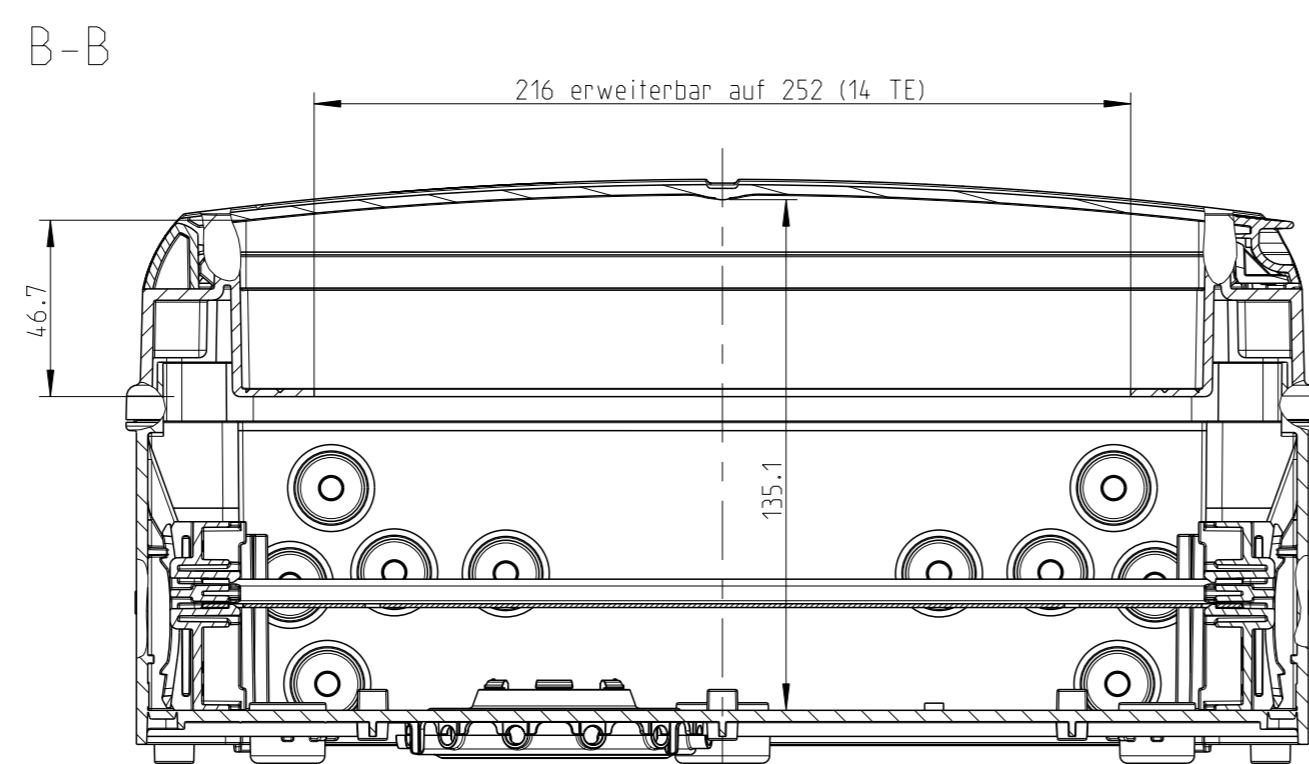

A-A
4.5

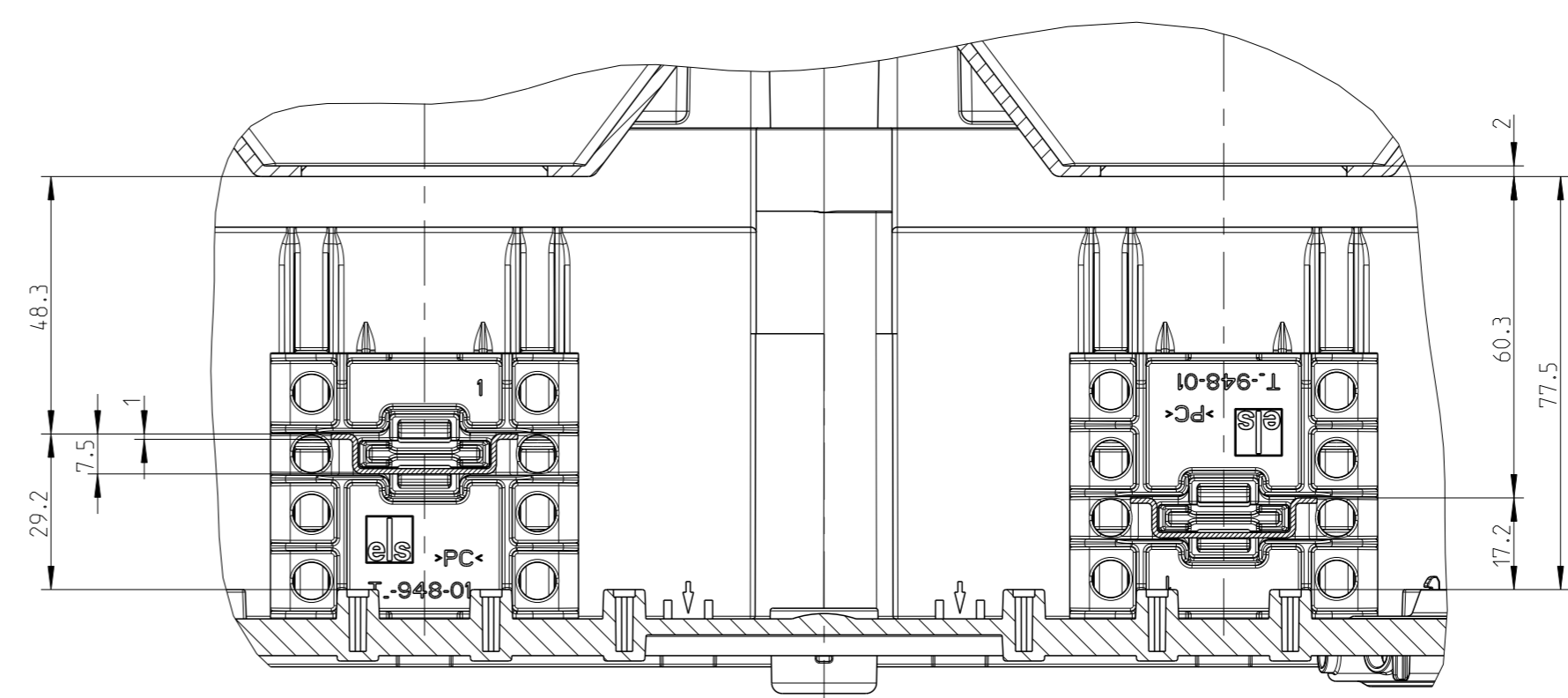

Innenansicht/ interior view

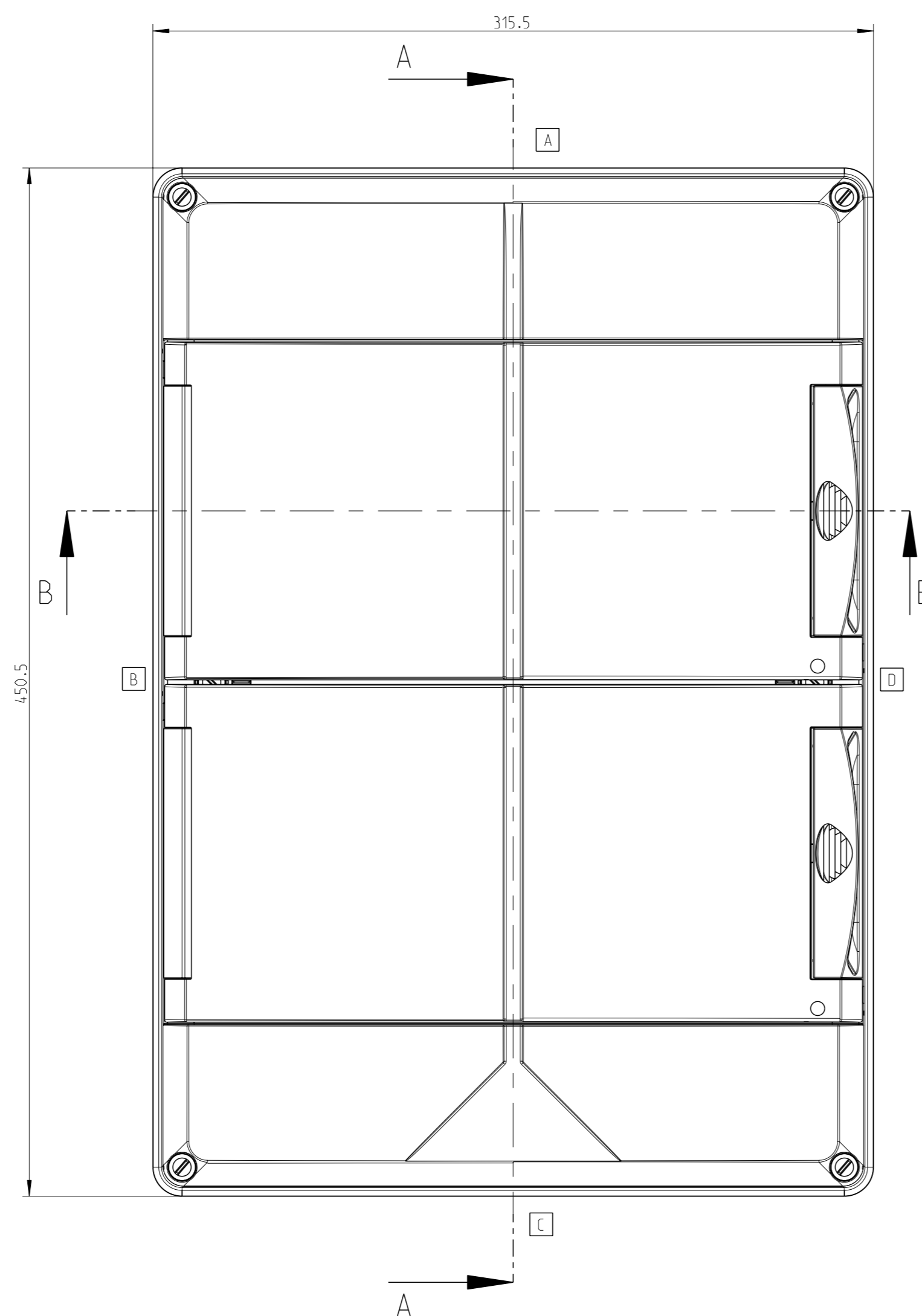
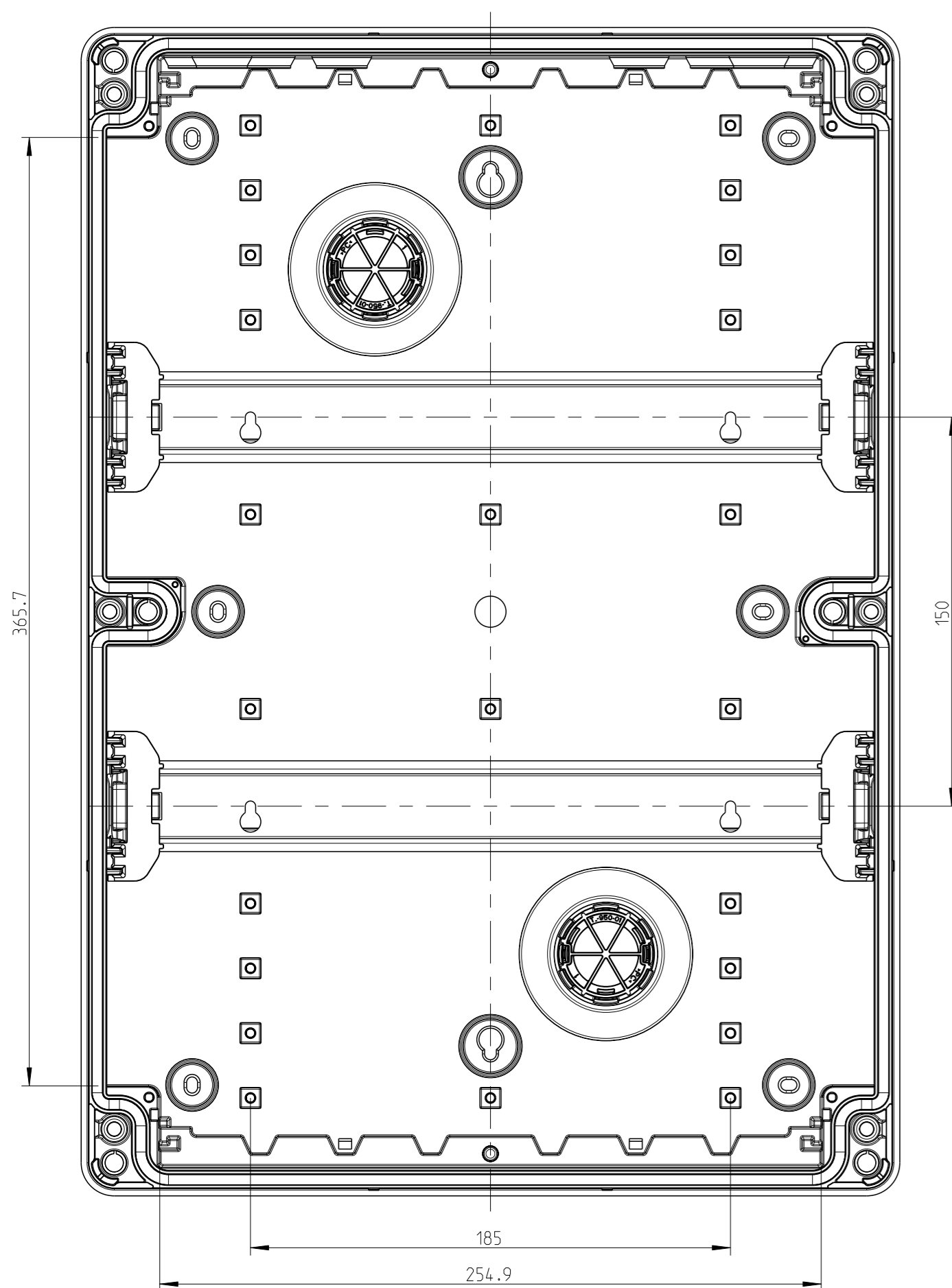

A-A

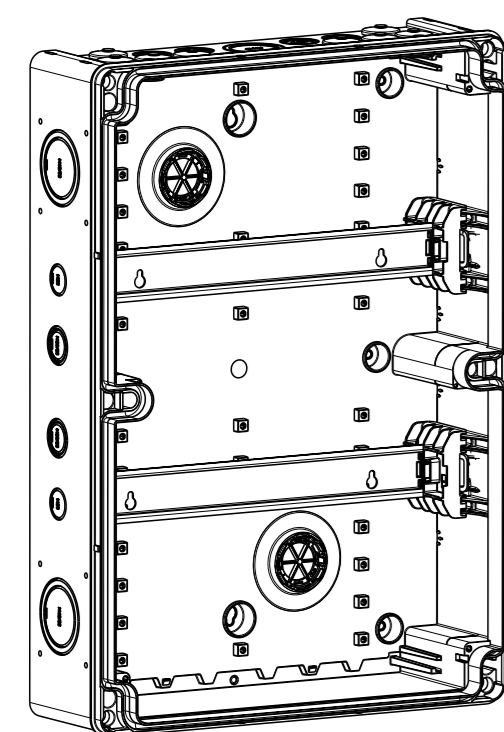
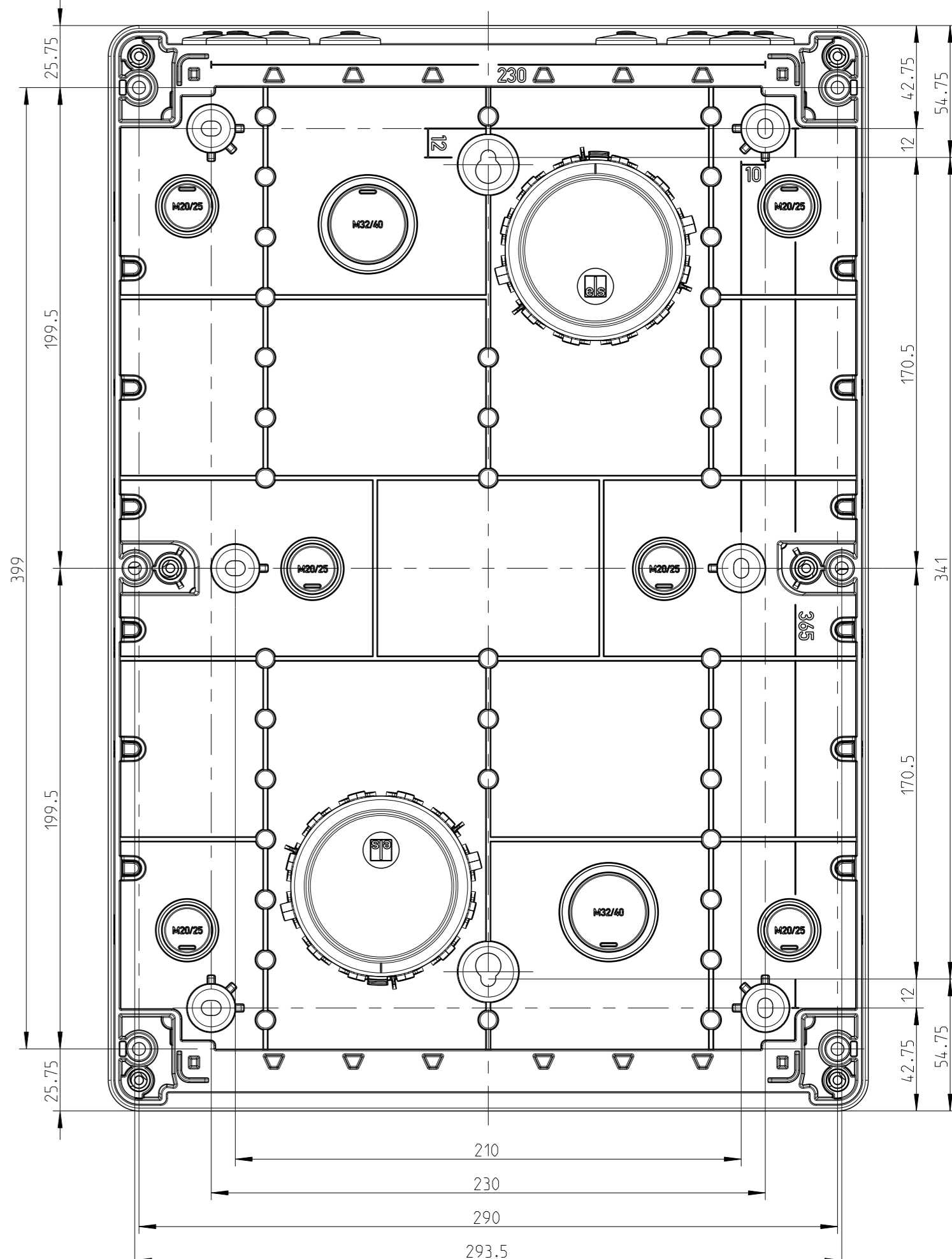
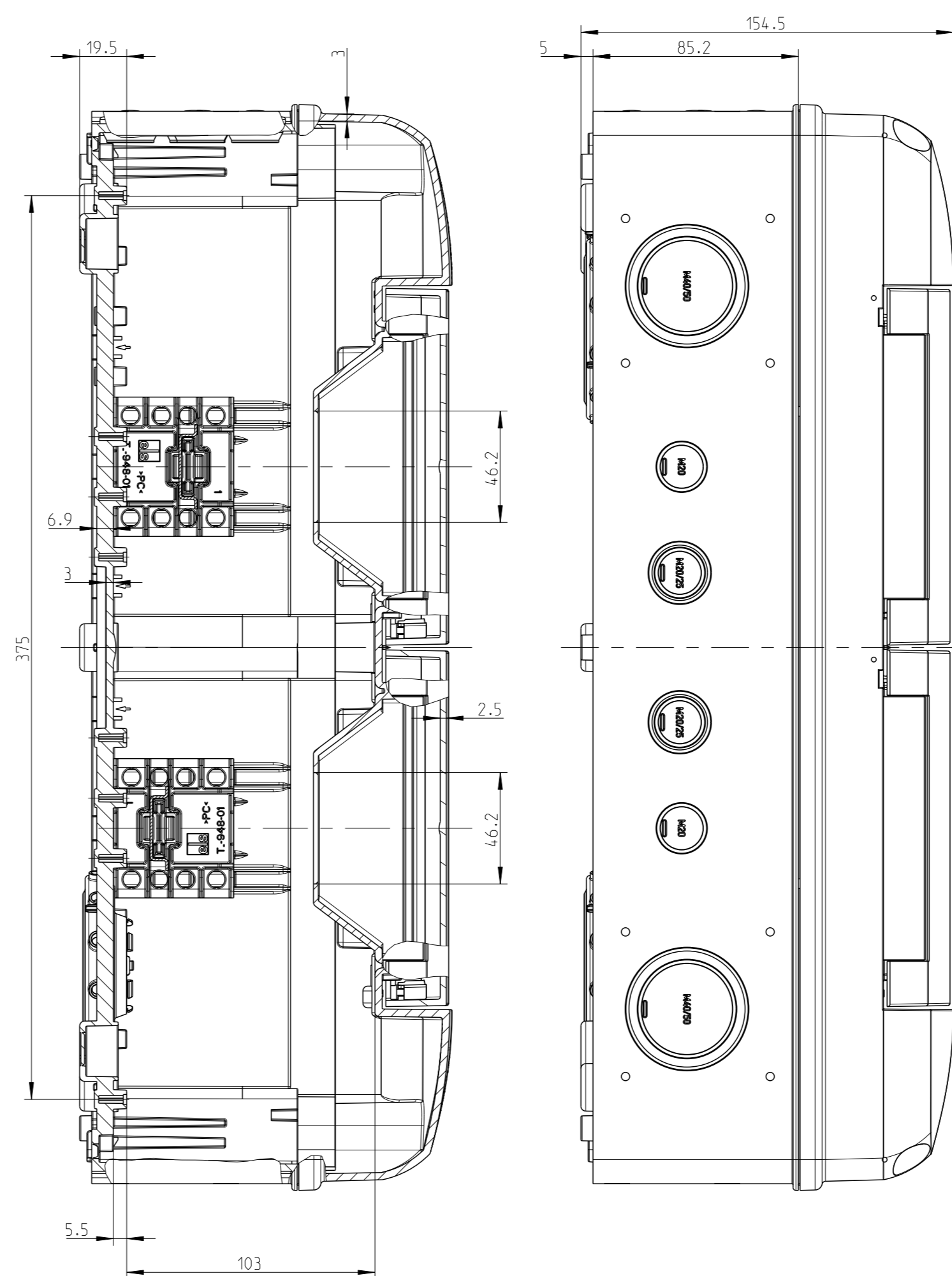

1:5

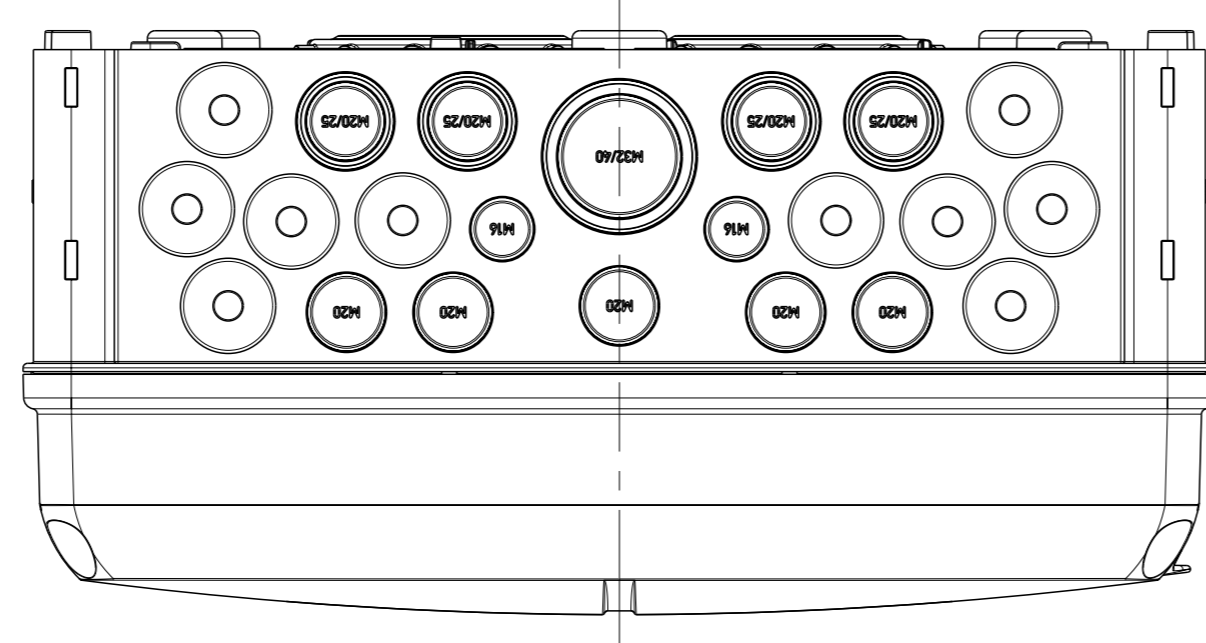

Fehlende Maße können dem DXF entnommen werden

missing dimensions are provided in the DXF