

40mm sq.

San Ace 40



General Specifications

- Material Frame: Plastics (Flammability: UL94V-0),
Impeller: Plastics (Flammability: UL94V-1)
- Expected Life Refer to specifications (L10:Survival rate:90% at 60°C ,
rated voltage, and continuously run in a free air state)
- Lead Wire ⊕red ⊖black or blue (Sensor) yellow
- Storage Temperature -30°C to +70°C (Non-condensing)

40×40×20mm (Mass : 45g) **9P** type

Specifications

The following nos. **have pulse sensors and ribs.**

Model No.	Rated Voltage [V]	Operating Voltage Range [V]	Rated Current [A]	Rated Input [W]	Rated Speed [min ⁻¹]	Max. Airflow [m ³ /min] [CFM]	Max. Static Pressure [Pa] [inchH ₂ O]	SPL [dB(A)]	Operating Temperature [°C]	Expected Life [h]
109P0405J601	5	4.5 to 5.5	0.46	2.3	9,800	0.28 9.9	98.5 0.396	39	-20 to +70	40,000/60°C
109P0405H601			0.32	1.6	8,000	0.225 8.0	65.7 0.264	33		
109P0405F601			0.25	1.25	6,500	0.183 6.5	45.1 0.181	28		60,000/60°C
109P0405M601			0.12	0.60	5,000	0.136 4.8	26.5 0.106	24		
109P0412G601	12	7 to 13.8	0.28	3.36	12,500	0.35 12.4	153.8 0.618	44	-20 to +60	40,000/60°C
109P0412D601			0.18	2.16	11,000	0.31 10.9	124 0.498	42		
109P0412E601			0.13	1.8	9,200	0.26 9.2	87.3 0.351	37	-20 to +70	60,000/60°C
109P0412H601			0.11	1.32	8,000	0.225 8.0	65.7 0.264	33		
109P0412F601			0.09	1.08	6,500	0.183 6.5	45.1 0.181	28		
109P0412M601			0.06	0.72	5,000	0.136 4.8	26.5 0.106	24		
109P0424G601	24	12 to 27.6	0.15	3.6	12,500	0.35 12.4	153.8 0.618	44	-20 to +60	40,000/60°C
109P0424D601		12 to 27.6	0.13	3.12	11,000	0.31 10.9	124 0.498	42		
109P0424H601		12 to 27.6	0.07	1.68	8,300	0.233 8.2	69.6 0.280	35	-20 to +70	60,000/60°C
109P0424F601		14 to 27.6	0.06	1.44	6,500	0.183 6.5	45.1 0.181	28		
109P0424B601		20.4 to 27.6	0.06	1.44	5,200	0.14 4.9	28.3 0.114	25		

Other sensor specifications are available as options. Please refer to the index (pp. 496 to 497).

Dimensions (unit: mm)

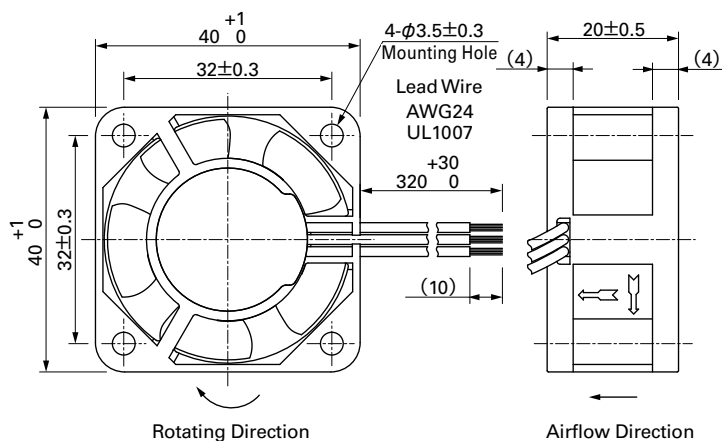

Reference Dimensions of Mounting Holes and Vent Opening (unit: mm)

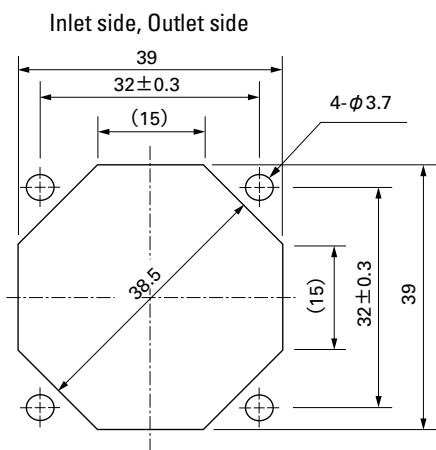

Options (unit: mm)

Finger Guards

Model : 109-059 Surface treatment : Nickel-chrome plating (silver) Color : Nickel-chrome plating (silver)
: 109-059H : Cation electropainting (black) Color : Cation electropainting (black)

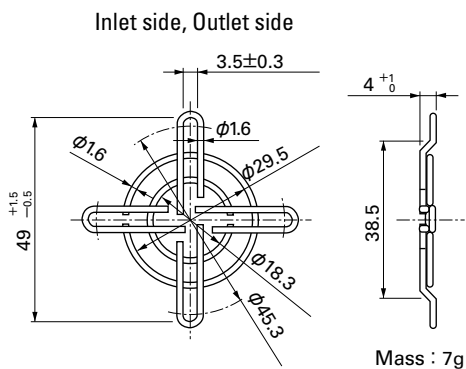

40 mm sq.

San Ace 40

40×40×20mm [Mass : 45g]

Airflow - Static Pressure Characteristics

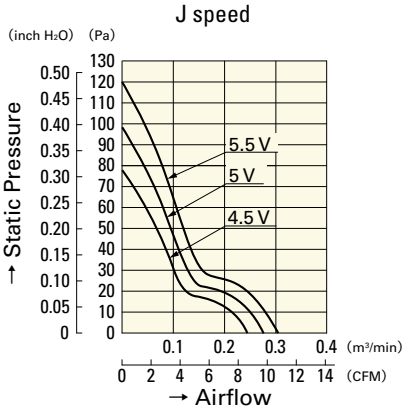

109P0405J601

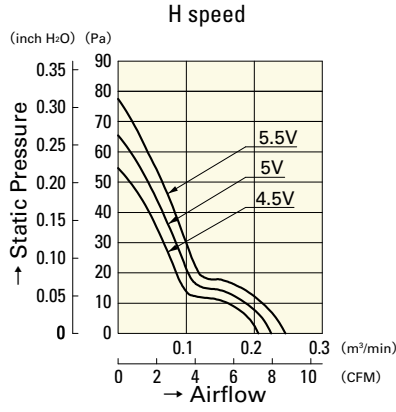

109P0405H601

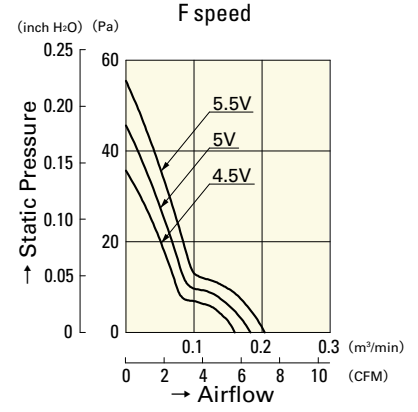

109P0405F601

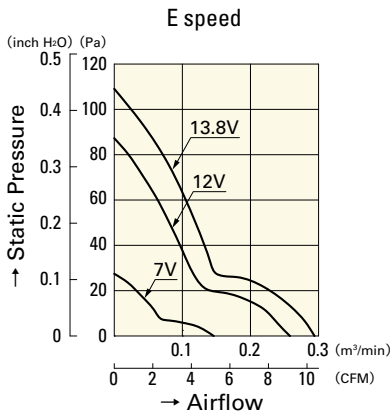

109P0412E601

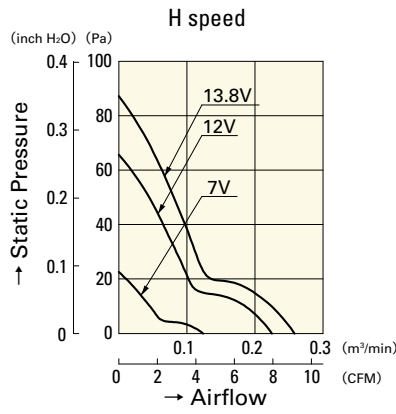

109P0412H601

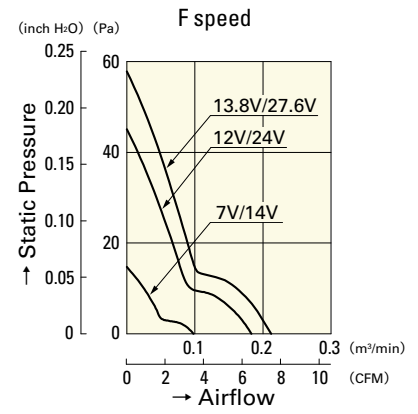

109P0412F601
109P0424F601

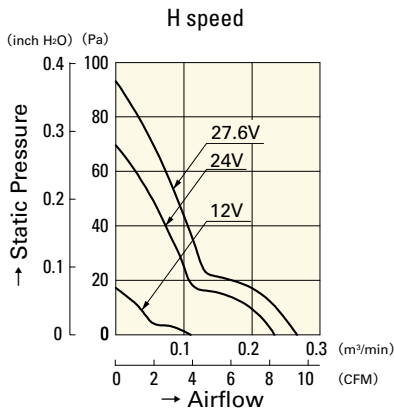

109P0424H601

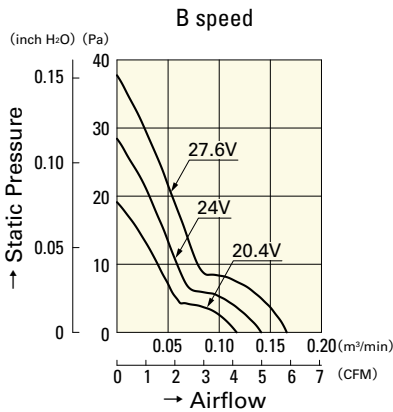

109P0424B601

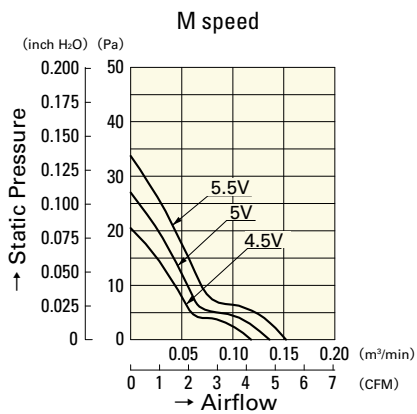

109P0405M601

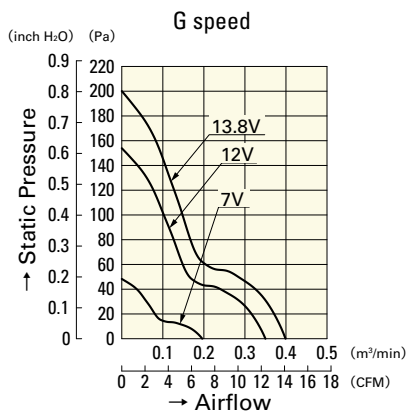

109P0412G601

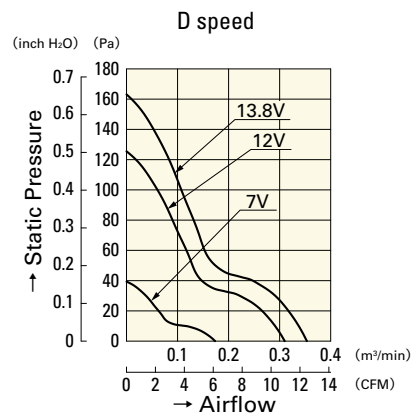

109P0412D601

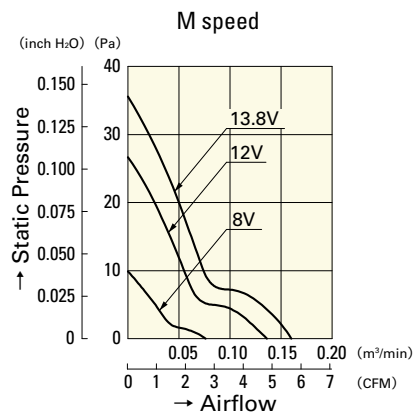

109P0412M601

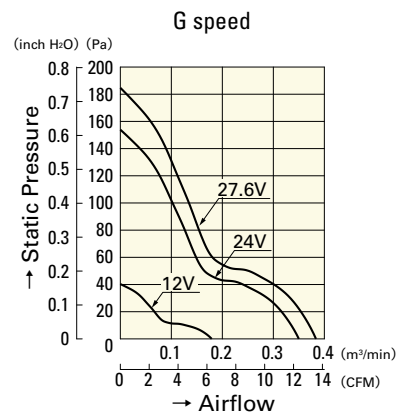

109P0424G601

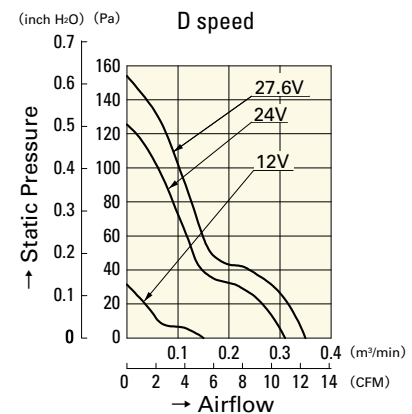

109P0424D601