

MDD DC/DC-CONVERTOR SWITCH MODE

IN: 24VDC OUT: 24V/0,3ADC

INPUT: 24 V DC
OUTPUT: 24 V DC
Output rating: 7 W
Current: 0.3 A[Link to Product](#)**Illustration**

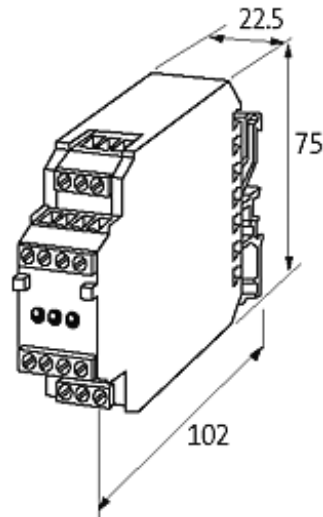

Product may differ from Image

Input

Input voltage	24 V DC
Input current	0.6 A
Input fuse (external)	2 A (T)
Input fuse (internal)	1.5 A (T)

General data

Standards	(EN 61204-3)
Test isolation voltage	4 kV (input/output)
Mounting method	DIN-rail mountable TH35 or G32 (EN 60715)
Temperature range	0...+50 °C, no condensation

Output

Output fuse	short-circuit and overload protected, restart after overload by removing power supply
Output voltage	24 V DC (SELV), $\pm 2\%$
Output current	max. 0.3 A
Ripple	max. 0.2 %rms

Commercial data

country of origin	CZ
customs tariff number	85043121
minimum order quantity	1