

GoldMax 300 Comm X7R, Ceramic, 0.015 uF, 10%, 50 VDC, X7R, GoldMax, Commercial Standard, Lead Spacing = 2.54mm

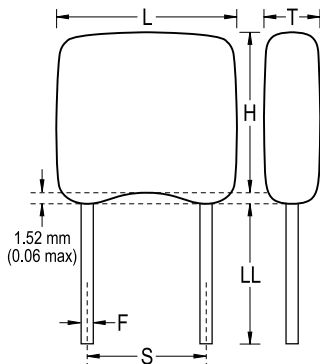

**Dimensions**

<b>L</b>	5.08mm MAX
<b>H</b>	5.84mm MAX
<b>T</b>	3.18mm MAX
<b>S</b>	2.54mm +/-0.78mm
<b>LL</b>	7mm MIN
<b>F</b>	0.51mm +0.1/-0.025mm

**Packaging Specifications**

<b>Packaging:</b>	Bulk, Bag
<b>Packaging Quantity:</b>	500

**General Information**

<b>Series:</b>	GoldMax 300 Comm X7R
<b>Style:</b>	Radial
<b>Description:</b>	GoldMax, Commercial Standard
<b>RoHS:</b>	Yes
<b>Termination:</b>	Tin
<b>Failure Rate:</b>	N/A
<b>AEC-Q200:</b>	No
<b>Halogen Free:</b>	Yes

**Specifications**

<b>Capacitance:</b>	0.015 uF
<b>Measurement Condition:</b>	1 kHz 1.0Vrms
<b>Capacitance Tolerance:</b>	10%
<b>Voltage DC:</b>	50 VDC
<b>Dielectric Withstanding Voltage:</b>	125 VDC
<b>Temperature Range:</b>	-55/+125°C
<b>Temperature Coefficient:</b>	X7R
<b>Capacitance Change with Reference to +25°C and 0 VDC Applied (TCC):</b>	0.15, 1kHz 1.0Vrms
<b>Dissipation Factor:</b>	2.5% 1 kHz 1.0Vrms
<b>Aging Rate:</b>	3% Loss/Decade Hour
<b>Insulation Resistance:</b>	66.67 GOhms

Statements of suitability for certain applications are based on our knowledge of typical operating conditions for such applications, but are not intended to constitute - and we specifically disclaim - any warranty concerning suitability for a specific customer application or use. This Information is intended for use only by customers who have the requisite experience and capability to determine the correct products for their application. Any technical advice inferred from this Information or otherwise provided by us with reference to the use of our products is given gratis, and we assume no obligation or liability for the advice given or results obtained.